

JAEGER
CONNECTEURS

STANDARD CONNECTOR SERIES



JAEGER BY HUMMEL

JAEGER Connecteurs



The JAEGER values

Quality

„Quality attracts attention“, E. JAEGER (1924).
This has been the motto of the entire company for almost 60 years,
contributing to our customers' satisfaction.

Innovation

Innovation comes from listening to your needs. This is why JAEGER
founded VINCI, its „Smart Industrial and Commercial intelligence“,
working group, the role of which is to integrate the latest cutting-
edge technologies into our products.

Service

Our priority at JAEGER Connecteurs is customer satisfaction. Our
sales department offers technical solutions adapted to your needs.

Constantly adapting

At JAEGER we are continuously adapting our offer to the needs of
the market in the following fields: automation, robotics, power,
medical, automotive, marine, railway, aerospace, electricity-
electronics, agrifood, etc.

Interconnection systems

JAEGER Connecteurs offers ranges of overmoulded cords, distributors
and connectors to wire or prewired, for all interconnection solutions.



Circular Connectors

JAEGER Connecteurs offers families of circular connectors adapted to usage in rough industrial environments:
Requiring a greater or lesser degree of tightness; Compactness and multiplexing; Carrying current of varying strength;
weight, cost and more.



Connectors with non-removable contacts



Standard Series

- Standard	10
- Standard High Voltage	12
- Standard with thermocouple contacts	14

Rapid Series

- Rapid	16
- Rapid with gold-plated contacts	18
- Rapid High Voltage	20

Weatherproof Series

- Weatherproof	22
- Weatherproof High-Performance PG outlet	24
- Weatherproof PG outlet	26

Hermetic Series

- Hermetic Standard: Panel connector attached by welding	28
- Hermetic Standard: Panel connector attached by locknut	30
- Hermetic Standard: Bulkhead connector attached by locknut	32
- Hermetic Pneurop	34
- Hermetic Ultra-Vide	36
- Hermetic Push-Pull	38

Connectors with removable contacts – Power Series Puissance



Single-pole connectors

- 300 A circular single-pole 95 mm ²	86
- 175 A rectangular single-pole 35 mm ²	88

Multi-pole connectors, 3 contacts + 2 pilots

- 175 A circular multi-pole 35 mm ²	90
- 175 A circular multi-pole 25 mm ²	92
- 175 A rectangular multi-pole 25 mm ²	92

Multi-pole connectors, 4 contacts

- 175 A circular multi-pole 25 mm ²	94
--	----

Connectors with removable contacts



Miniature Push-Pull Series

- Atto Miniature Push-Pull	46
- Natto Miniature Push-Pull	48
- Natto Miniature Push-Pull High-Performance	50

Miniature Series

- Miniature	52
- Weatherproof Miniature	54
- Miniature with ground contact	56
- Weatherproof Miniature with ground contact	58
- Miniature with bulkhead connector	60

Industrial Series

- Industrial	62
- Industrial Weatherproof	64
- Industrial High-Performance	66
- Industrial with 17 mixed contacts	68
- Industrial with bulkhead connector	70

Marine Series

- Marine	72
----------	----

Neptunox Series

- Neptunox	74
------------	----

Robotic Series

- Robotic	78
- Robotic with 17 mixed contacts	80

Minex Series

- Minex	82
---------	----

Printed Circuits Series

- Atto and Natto Miniature Push-Pull/Miniature/Industrial/Minex	84
---	----

Accessories



Cable clamps	106
Protective caps	110
Gaskets and seals	115
Housings for panel connectors	116
Screws and nuts for panel connector attachment	118
Ground kit	118
Couplings for flexible hoses	119
Spare parts for circular panel connectors	120
Conexil	120
Accessories for sealable connectors	121
Sleeves	121
End fittings for soldering	122
PG and ISO threaded end fittings	122
Crimp End fittings	123
End fittings for pyrometer tubes	123
Threaded adaptors for connectors	123
Blanking plate kit for partitions	123
Ground terminal	124
Cable gland	124
Union nut	125
Replacement contacts	125
Thermocouple contacts	126

Numerical Index

Connectors with non-removable contacts	40
Connectors with removable contacts	96
Accessories	129
Technical guides	173

Technical guides



Contact arrangement

- Standard, Rapid, Weatherproof and Hermetic Series	134
- Atto Miniature Push-Pull Series	135
- Miniature, Natto Miniature Push-Pull, Marine, Neptunox, Robotic and Minex Series (σ 1 mm)	136
- Natto Miniature Push-Pull, Industrial, Marine, Neptunox and Robotic Series (σ 1,6 mm and 2,4 mm)	137
- Power Series Puissance	138
- Industrial and Robotic Series with 17 mixed contacts	139
- Neptunox Series	140

Assembly

- Standard and Rapid Series	142
- Weatherproof, Weatherproof High-Performance PG outlet and Weatherproof PG outlet Series	144
- Miniature Push-Pull Series	146
- Miniature and Industrial Series	148
- Weatherproof Miniature and Industrial Weatherproof Series	150
- Marine Series	152
- Robotic Series	154
- Robotic Series with 17 mixed contacts	156
- Minex Series	158
- Power Series Puissance	160

Attachment of panel connectors to a wall	162
--	-----

Polarisation systems	165
----------------------------	-----

Wiring

- Conductor stripping	166
- Soldering contacts	168
- Crimping contacts	170
- Assembly of contacts	173

General points

Multi-contact connectors

All of an electrical connection can be assembled: Our contacts are designed to replace those in our connectors with removable contacts. 1 cable connector and 1 panel connector / or / 1 cable connector and 1 coupler connector.

- **Male / female panel connector:** fixed part of the connector intended to be attached to a device, a wall, a bay, a mobile or immobile assembly.
- **Male / female cable connector:** mobile part of the connector, normally attached to the free end of a cable or flexible electric conduit.
- **Male / female coupler connector:** mobile part of the connector normally attached to the free end of a cable or a flexible electric conduit; connection to the cable connector.

Possible connections:

Female cable connector	Male panel connector	Attaches to a device, a wall, a bay, etc.
Female cable connector	Male coupler connector	To make an extension
Male cable connector	Female panel connector	Attaches to a device, a wall, a bay, etc.
Male cable connector	Female coupler connector	To make an extension

Specific feature of our rectangular housings

Our connectors with rectangular housings have 3 possible cable outlets: A, B or C

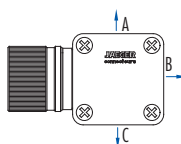

The barrel is mounted on the housing in different positions

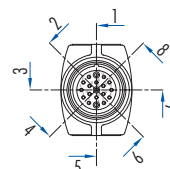

IP protection rating

Our connectors are protected against the risk of contact and against the entry of foreign substances and water.

- **IP 50:** Protection against dust, no harmful deposit. No protection against water penetration.
- **IP 54:** Protection against dust, no harmful deposit. Protection against water splashes.
- **IP 65:** Fully protected against dust. Protection against jets of water.
- **IP 68:** Fully protected against dust. Protection against prolonged immersion.

Connectors with non-removable contacts

Standard Series / Standard Thermocouple Series / Rapid Series / Weatherproof Series / Hermetic Series



Connectors with non-removable contacts

Standard Series



Standard
Standard High Voltage

Our Standard Series is particularly versatile. It is a sound value, simple yet robust.

- Multi-pole with 3 to 52 solder contacts
- Screw locking
- IP 50 – 54
- Rectangular housing with 3 possible cable outlets

Standard Thermocouple Series



Standard with Thermocouple contacts

Our Thermocouple Series is particularly suitable for applications requiring temperature measurements.

- Multi-pole with 3 solder contacts
- Screw locking
- IP 50 – 54
- Thermocouple type J / K / T

Rapid Series



Rapid
Rapid with gold-plated contacts
Rapid High Voltage

Our Rapid Series is a development of our Standard Series with a quick locking system. It is also available in a gold-plated contact version and in a single-contact high voltage version

- Multi-pole with 3 to 17 solder contacts
- 1/6 of a turn click locking
- IP 50 – 54
- Rectangular housing with 3 possible cable outlets

Weatherproof Series



Weatherproof
Weatherproof High-Performance PG
Weatherproof PG

Our Weatherproof Series is particularly suitable for environments subject to splashes of water. It is also available in a high-performance version for more stringent requirements.

- Multi-pole with 3 to 52 solder contacts
- Screw locking
- IP 65
- Circular housing

Hermetic Series



Hermetic Standard:
• Panel connector attached by welding
• Panel connector attached by locknut
• Bulkhead connector attached by locknut

Hermetic Pneurop
Hermetic Ultra-Vide
Hermetic Push-Pull

Our Hermetic Series uses precision technology designed for vacuum environments, high pressure and gas tightness.

- Multi-pole with 3 to 52 solder contacts
- Screw locking
- Leak rate: 10 – 9 Atm. cm³ / second with helium

Illustrated table of connections

Recommended assembly

*Possible assembly

*All the assemblies shown can be created, but some are not always the ideal solution.

			Cable connector																								
			Female					Male																			
			Standard	Standard HV	Thermo-couple	Rapid	Rapid gold	Rapid HV	Weather-proof	Weather-proof HP	Weather-proof PG	Standard	Rapid	Rapid gold	Rapid HV	Weather-proof	Weather-proof HP	Weather-proof PG									
Panel connector	Male	Square	Standard										from 3 to 17 contacts														
			Standard HV																								
			Thermo-couple																								
			Rapid																								
			Rapid gold																								
	Rapid HV																										
	Weatherproof																										
	Weatherproof HP																										
	Weatherproof PG	from 3 to 17 contacts																									
		Circular	Standard																								
Weatherproof																											
Weatherproof HP																											
Weatherproof PG	from 3 to 17 contacts																										
Hermetic (except Push-Pull)																											
Coupler connector	Male	Standard																									
		Thermo-couple																									
		Rapid																									
		Rapid gold																									
		Weatherproof																									
		Weatherproof PG	from 3 to 17 contacts																								
Panel connector	Female	Square	Standard																								
			Rapid																								
			Rapid gold																								
			Rapid HV																								
			Weatherproof																								
			Weatherproof HP																								
	Coupler connector	Female	Standard																								
Rapid																											
Rapid gold																											

Technical Data

RoHS

Panel connector, cable connector and coupler connector

Panel connector



Cable connector



Coupler connector



Panel connector, cable connector and coupler connector	rectangular housing
Locking	screw connection
Protection	IP 50 to IP 54 with conexil in the housing, flat-gasket for panel connector and cable connector seal
Contacts	3 to 52 contacts \varnothing 2 mm – \varnothing 3 mm – \varnothing 4 mm non-removable solder contacts
Max. current	15 A \varnothing 2 mm – 35 A \varnothing 3 mm – 50 A \varnothing 4 mm
Contact resistance between pin and socket	$< 0,0015\Omega$ \varnothing 2 mm – $< 0,0010\Omega$ \varnothing 3 mm – $< 0,0007\Omega$ \varnothing 4 mm
Breakdown voltage between adjacent contacts	> 2500 Volts (RMS)
Breakdown voltage between peripheral contacts and ground	> 1500 Volts (RMS), (> 2000 Volts (RMS) 4 contacts \varnothing 4 mm)
Insulation resistance	> 5000 M Ω
Operating temperature	-40 °C to +100 °C (500 hours at +125 °C)
Materials	Nickel-plated light alloy, silver-plated brass contact, PBT insert except contacts diameter 4 mm which are gold-plated brass
Max. cross-section of soldered conductors	1,34 mm ² \varnothing 2 mm – 3,18 mm ² \varnothing 3 mm – 5,26 mm ² \varnothing 4 mm

Dimensional Data

Panel connector

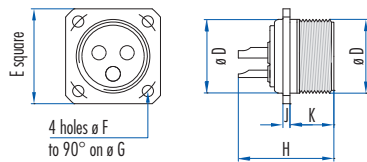

Circular male panel connectors housings 1 and 2

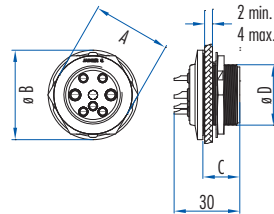

Circular male panel connectors housings 3 to 5

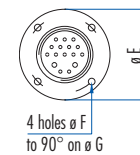

Cable connector

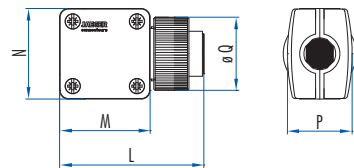

Coupler connector

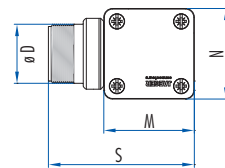

Cable connector – Panel connector assembly

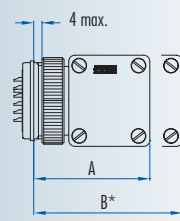

Housing	Number of Contacts	Circular male panel connector						
		A	\varnothing B	C	\varnothing D	\varnothing E	\varnothing F	\varnothing G
1	3-4-6	29	34	16,5	M21			
2	4-8-12	35	40	16,5	M27			
3	17					57	4,2	48
4	25					63	4,2	54
5	35-52					72	4,2	62

Housing	Number of Contacts	Assembly	Square and circular male panel connector													Female cable connector – Male coupler connector																
			A	B	\varnothing D	E	\varnothing F	\varnothing G	H	J	K	L	M	N	P	\varnothing Q	S	A	B	\varnothing D	E	\varnothing F	\varnothing G	H	J	K	L	M	N	P	\varnothing Q	S
1	3-4-6		52	64	21	27	3,2	28	25	2	12,7	51,2	32,2	32,2	23	26	51,8	56	66	21	27	3,2	28	28,7	2	16	51,5	32,2	32,2	23	26	52
2	4		56	68	27	32	3,2	34	29	2	12,5	55,2	36,4	36,4	28,4	33	56,5	60	70	27	32	3,2	34	28,6	2,1	16	55	36,4	36,4	28,4	33	56,4
2	8-12		56	68	27	32	3,2	34	21	2	12,5	55,2	36,4	36,4	28,4	33	56,5	60	70	27	32	3,2	34	28,6	2,1	16	55	36,4	36,4	28,4	33	56,4
3	17		64	75	39	43	4,2	48	23	2	12	62,4	42,6	47,6	38,6	44	62	68	83	39	43	4,2	48	29,8	2	18,6	62,5	42,6	47,6	38,6	44	67,5
4	25		68	81	45	47	4,2	54	23,8	2	12	67,6	47,8	53,8	44,8	51	69	73	87	45	47	4,2	54	29,8	2	18,6	67,2	47,8	53,8	44,8	50	72,5
5	35		78	89	52	54	4,2	62	28,8	1,9	12,1	74,5	55	61,5	51,5	58	76	80,5	93	52	54	4,2	62	30,6	2	18,6	74,5	55	61,5	51,5	58	
5	52		78	89	52	54	4,2	62	28	1,9	12,1	74,5	55	61,5	51,5	58	76	80,5	93	52	54	4,2	62	30,6	2	18,6	74,5	55	61,5	51,5	58	

* B: minimum disconnection distance

Part Number

Housing	1	1	1	2	2	2	3	4	5	5
Number of Contacts	3	4	6	4	8	12	17	25	35	52
L ø 2 mm	1	4	6		6	12	15	23	33	52
L ø 3 mm	2				2		2	2	2	
L ø 4 mm				4						

Male panel connectors – Female cable connectors – Male coupler connectors

Circular male panel connector*	°536 753 006	°536 754 006	°536 756 006		°536 758 006	°536 762 006	°536 117 006	°536 125 006	°536 135 006	°533 706 006
Square male panel connector	°038 351 006	°043 082 006	°038 355 006	°533 763 006	°038 356 006	°038 359 006	°038 322 006	°042 986 006	°043 001 006	°533 703 006
Female cable connector	042 953 006	043 085 006	042 954 006	530 763 006	042 955 006	042 956 006	038 382 006	042 977 006	042 990 006	530 703 006
Male coupler connector	532 203 006	532 204 006	532 206 006	530 768 006	532 208 006	532 212 006	532 217 006	532 225 006	532 235 006	530 707 006
Type 3 cable clamp	630 135 006	630 135 006	630 135 006	630 138 006	630 138 006	630 138 006	630 155 006	630 155 006	630 175 006	630 175 006
Flat-Gasket for panel connector (pack of 10)	536 945 006	536 945 006	536 945 006	536 946 006	536 946 006	536 946 006	536 947 006	536 126 006	536 136 006	536 136 006
Protective cap for panel connector	536 910 006	536 910 006	536 910 006	536 911 006	536 911 006	536 911 006	536 912 006	536 913 006	536 914 006	536 914 006
Protective cap for female cable connector	532 260 006	532 260 006	532 260 006	532 278 006	532 278 006	532 278 006	532 262 006	532 268 006	532 269 006	532 269 006
Protective cap for coupler connector	536 910 606	536 910 606	536 910 606							

Female panel connectors – Male cable connectors – Female coupler connectors

Square female panel connector	°536 603 006	°536 604 006	°536 606 006	°533 760 006	°536 608 006	°536 612 006	°536 617 006	°536 625 006	°536 635 006	°533 700 006
Male cable connector	532 603 006	532 604 006	532 606 006	530 760 006	532 608 006	532 612 006	532 617 006	532 625 006	532 635 006	530 700 006
Female coupler connector	"530 153 006	"530 154 006	"530 156 006	"530 753 006	"530 158 006	"530 162 006	530 170 006	530 175 006		
Type 3 cable clamp	630 135 006	630 135 006	630 135 006	630 138 006	630 138 006	630 138 006	630 155 006	630 155 006	630 175 006	630 175 006
Flat-Gasket for panel connector (pack of 10)	536 945 006	536 945 006	536 945 006	536 946 006	536 946 006	536 946 006	536 947 006	536 126 006	536 136 006	536 136 006
Housing for panel connector	536 935 006	536 935 006	536 935 006	536 937 006	536 937 006	536 937 006	536 996 006	536 880 006	536 881 006	536 881 006
Protective cap for panel connector	536 910 006	536 910 006	536 910 006	536 911 006	536 911 006	536 911 006	536 912 006	536 913 006	536 914 006	536 914 006
Protective cap for male cable connector	532 265 006	532 265 006	532 265 006	532 279 006	532 279 006	532 279 006	532 267 006	532 268 006	532 269 006	532 269 006
Protective cap for coupler connector	536 910 606	536 910 606	536 910 606							

- For the version with 4 contacts ø 4 mm, contact No. 4 of the panel connector and the coupler connector, which makes the electrical connection before the other 3 contacts and disconnects it after separation, can be used as a ground contact.
- ° The panel connectors are also compatible with the Weatherproof cable connectors page 22 and Weatherproof PG cable connectors page 26.
- " Square female panel connectors and female coupler connectors are also of the „Rapid“ type, page 16 with 3 to 12 contacts.
- Sealable tamper-evident connectors for housings 1 and 2. See: Accessories.
- For assembly, wiring, panel connector installation and contact arrangement instructions, see: Technical guides.
- Other accessories, see: Accessories.
- * The circular male panel connector with 3 to 12 contacts includes a body, a seal, a nut and its locknut.

Technical Data

RoHS

Panel connector



Cable connector



Panel connector and cable connector	rectangular housing
Locking	screw connection
Protection	IP 50 to IP 54 with conexil in the housing, flat-gasket for panel connector and cable connector seal
Contact	single contact \varnothing 2 mm non-removable solder contact
Max. current	15 A \varnothing 2 mm
Contact resistance between pin and socket	$< 0,0015 \Omega \varnothing$ 2 mm
Maximum voltage in steady state	> 2500 Volts
Test voltage	6000 Volts (2U + 1000)
Insulation resistance	$> 10^6 M\Omega$
Operating temperature	-20 °C to +100 °C (100 hours at +100 °C)
Materials	Nickel-plated light alloy, silver-plated brass contact, thermoplastic insert
Max. cross-section of soldered conductors	(shielded or unshielded high-voltage cable) 1,91 mm ² \varnothing 2 mm

Dimensional Data

Panel connector

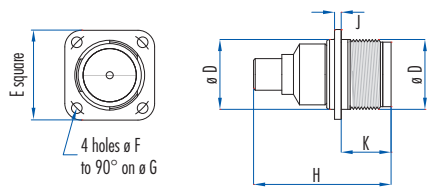

Cable connector

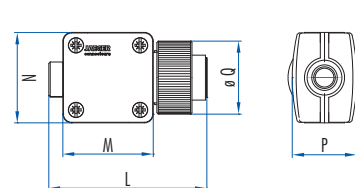

Cable connector – Panel connector assembly

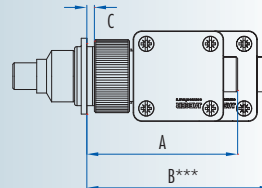

Housing	Number of Contacts	Assembly			Square male panel connector							Female cable connector					
		A	B	C	ØD	E	ØF	ØG	H	I	J	K	L	M	N	P	ØQ
1	1	67	78	4	21	27	3,2	28	38,5	M21	2	12,7	58,5	32,2	32,2	23	26

*** B: minimum disconnection distance

Part Number

Housing	1
Number of Contacts ø 2 mm	1
Male panel connector – Female cable connector	
Square male panel connector	536 893 006
Female cable connector	532 893 006
Housing for panel connector	536 886 006
Flat-Gasket for panel connector (pack of 10)	536 945 006

- Sealable tamper-evident connectors, see: Accessories.
- For wiring and panel connector installation instructions, see: Technical guides.

Preparing the cable

Warning: When the circuit is under load:

- Do not separate the two parts of the connector
- Do not fit or remove the protective caps on connectors
- Use shielded or unshielded high-voltage cables. Maximum cross-section of the conductor: 1,91 mm².
- To wire the panel connector, use a housing with cable clamp or the assembly shown below. A lug is delivered with the panel connector for the electrical continuity of the cable shielding, if necessary.
- To achieve the performances previously stated, the assembly instructions given on the diagram below must be strictly adhered to.
- The polyethylene insulating sleeves must be fully inserted into their seating.

Cable connector side

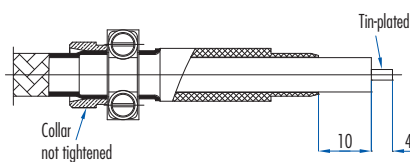

Panel connector side

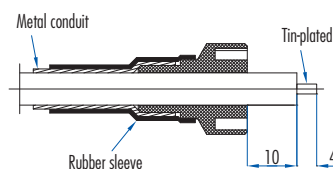

Thermocouple Series – Standard with Thermocouple contacts

Technical Data

RoHS

Panel connector, cable connector and coupler connector

Panel connector



Cable connector



Coupler connector



Panel connector, cable connector and coupler connector	rectangular housing
Locking	screw connection
Protection	IP 50 to IP 54 with conexil in the housing, flat-gasket for panel connector and cable connector seal
Contacts	3 contacts: 1 \varnothing 2 mm and 2 (the thermocouple) \varnothing 3 mm, non-removable solder contacts
Max. current	15 A \varnothing 2 mm – 35 A \varnothing 3 mm
Contact resistance between pin and socket	$< 0,0015 \Omega$ \varnothing 2 mm, Depending on thermocouple \varnothing 3 mm $< 0,0015 \Omega$ \longleftrightarrow $< 0,0045 \Omega$
Breakdown voltage between adjacent pins	> 1500 Volts (RMS)
Breakdown voltage between peripheral pins contact and ground	> 1500 Volts efficaces
Insulation resistance	> 5000 M Ω
Operating temperature	-40 °C to +100 °C (500 hours at +125 °C)
Materials	Nickel-plated light alloy, silver-plated brass contact, thermocouple contacts see below, PBT insert
Max. cross-section of soldered conductors	1,34 mm ² \varnothing 2 mm – 3,39 mm ² \varnothing 3 mm

Thermocouple	Identification of contacts		Identification of connectors by a coloured ring
	Polarity	Number	
iron	+	1	Black type J
constantan	-	2	
chromel	+	1	Green type K
alumel	-	2	
copper	+	1	Brown type T
constantan	-	2	

Dimensional Data

Panel connector

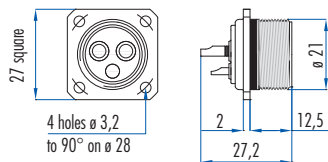

Cable connector

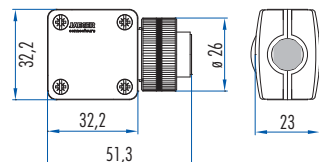

Coupler connector

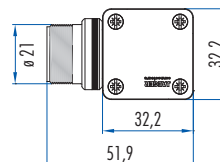

Thermocouple Series – Standard with Thermocouple contacts

Part Number

Housing	1	1	1
Number of Contacts	3	3	3
Thermocouple (J: iron constantan, K: chromel alumel, T: copper constantan)	J	K	T

Male panel connectors – Female cable connectors – Male coupler connectors

Square male panel connector	536 161 006	536 162 006	536 163 006
Female cable connector	532 161 006	532 162 006	532 163 006
Male coupler connector	532 121 006	532 122 006	532 123 006
Type 3 cable clamp	630 135 006	630 135 006	630 135 006
End fitting for soldering	532 998 006	or 042 547 006	or 042 937 006
Pyrometer tube end fitting	530 126 026	530 126 026	530 126 026
Protective cap for panel connector	536 910 006	536 910 006	536 910 006
Protective cap for cable connector	532 260 006	532 260 006	532 260 006
Protective cap for coupler connector	536 910 606	536 910 606	536 910 606

- For assembly, wiring, panel connector installation and contact arrangement instructions, see: Technical guides.
- Other accessories, see: Accessories.
- For configurations requiring a larger number of contacts and with different technical characteristics, see page 128.

Thermocouple data

In 1821, Seebeck discovered that an electric current flows in a closed loop with two wires made of different metals if the temperature of one of the two junctions is higher than that of the other. This bimetallic combination was called a **Thermocouple**.

If one of the junctions is open whilst keeping its two ends at the same temperature, the electromotive force measured between the two ends depends on the difference in temperature between the two junctions more precisely, the electromotive force depends on the temperature of a single junction if the other is maintained at constant temperature.

Different combinations of metals and alloys were tested to form a Thermocouple or Thermoelectric couple. The main types of pairs selected are:

- **Type J:** an iron component and a constantan component
- **Type K:** a chromel component and an alumel component
- **Type T:** a copper component and a constantan component
- **Type S:** a platinum rhodium 10% component and a platinum component
- **Type E:** a chromel component and a constantan component

There are other Thermocouples but they are less commonly used.

The thermoelectric properties thus discovered gave rise to temperature measurement in industry. Some examples of use: pyrometer tubes, freeze-driers, medical, engine bearing temperature control, etc.

The choice of Thermocouple is governed by:

- the temperature range to be measured
- its resistance to pollution and corrosion
- the resistance of the Thermocouple for a given gas atmosphere

Type	Colour Code <small>standard: IEC 584.3</small>	Conductor +	Conductor -	Temperature	Application recommended in atmospheres				
					vacuum	oxidizing	reducing	inert	gaseous
J	Black	Iron	Constantan	-210 °C +1200 °C	x	x	x	x	Air argon nitrogen
K	Green	Chromel	Alumel	-270 °C +1370 °C		x		x	Air argon
T	Brown	Copper	Constantan	-270 °C +400 °C		x	x		Air argon nitrogen
S	Yellow	platinum rhodium 10% Rh	Platinum	-50 °C +1760 °C		x			Air
E	Purple	Chromel	Constantan	-270 °C +1000 °C		x		x	Air argon

Technical Data

RoHS

Panel connector, cable connector and coupler connector

Panel connector



Cable connector



Coupler connector



Locking	rectangular housing screw up the knurled ring on the cable connector 1/6 of a turn on the panel connector barrel, for frequent locking and unlocking
Protection	IP 50 to IP 54 with conexil in the housing with flat-gasket for panel connector
Contacts	3 to 17 contacts \varnothing 2 mm – \varnothing 3 mm – \varnothing 4 mm non-removable solder contacts
Max. current	15 A \varnothing 2 mm – 35 A \varnothing 3 mm – 50 A \varnothing 4 mm
Contact resistance between pin and socket	< 1,5 m Ω \varnothing 2 mm – < 1 m Ω \varnothing 3 mm – < 0,7 m Ω \varnothing 4 mm
Breakdown voltage between adjacent contacts	> 2500 Volts (RMS)
Breakdown voltage between peripheral contacts and ground	> 1500 Volts (RMS), (> 2000 Volts (RMS) 4 contacts \varnothing 4 mm)
Insulation resistance	> 5000 M Ω
Operating temperature	-40 °C to +100 °C (500 hours at +125 °C)
Materials	Nickel-plated light alloy, silver-plated brass contact, PBT insert except contacts diameter 4 mm which are gold-plated brass
Max. cross-section of soldered conductors	1,34 mm ² \varnothing 2 mm – 3,18 mm ² \varnothing 3 mm – 5,26 mm ² \varnothing 4 mm

Dimensional Data

Panel connector

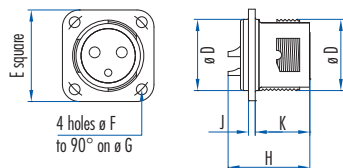

Cable connector

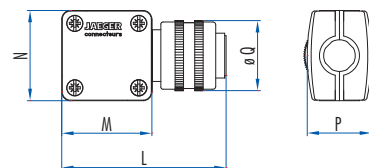

Coupler connector

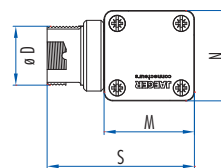

Cable connector – Panel connector assembly

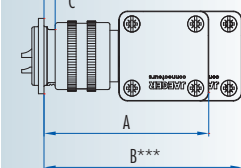

Housing	Number of Contacts	Assembly		Male panel connector										Female cable connector – Male coupler connector					Assembly		Female panel connector					Male cable connector – Female coupler connector							
		A	B	C	\varnothing D	E	\varnothing F	\varnothing G	H	J	K	L	M	N	P	\varnothing Q	S	A	B	C	\varnothing D	E	\varnothing F	\varnothing G	H	J	K	L	M	N	P	\varnothing Q	S
1	3-4-6	64	73	4	21	27	3,2	28	24,8	2	12,5	57	32,2	32,2	20,2	25	51	65	76	4	21	27	3,2	28	25	2	16	57	32,2	32,2	20,2	25	51
2	4	68	79	4	27	32	3,2	34	29	2	12,5	63	36,4	36,4	23,5	32	55	72	82	4	27	32	3,2	34	31	2	16	63	36,4	36,4	23,5	32	55
2	8-12	68	79	4	27	32	3,2	34	24	2	12,5	63	36,4	36,4	23,5	32	55	72	82	4	27	32	3,2	34	24	2	16	63	36,4	36,4	23,5	32	55
3	17	75	78	4	39	43	4,2	48	22,5	2	12,5	65	42,6	47,6	31,3	44	61	67	78	4	39	43	4,2	48	26	2	12	63	42,6	47,6	31,3	44	61

*** B: minimum disconnection distance

Part Number

Housing	1	1	1	2	2	2	3
Number of Contacts	3	4	6	4	8	12	17
L ø 2 mm	1	4	6		6	12	15
L ø 3 mm	2				2		2
L ø 4 mm				4			

Male panel connectors – Female cable connectors – Male coupler connectors

Square male panel connector	536 003 006	536 004 006	536 006 006	533 755 006	536 008 006	536 012 006	536 367 006
Female cable connector	532 003 006	532 004 006	532 006 006	530 755 006	532 008 006	532 012 006	532 367 006
Male coupler connector	532 103 006	532 104 006	532 106 006	530 752 006	532 108 006	532 112 006	530 117 006
Type 3 cable clamp	630 135 006	630 135 006	630 135 006	630 138 006	630 138 006	630 138 006	630 155 006
Flat-Gasket for panel connector (pack of 10)	536 945 006	536 945 006	536 945 006	536 946 006	536 946 006	536 946 006	536 947 006
Protective cap for panel connector	536 910 006	536 910 006	536 910 006	536 911 006	536 911 006	536 911 006	536 846 006
Protective cap for female cable connector	532 260 006	532 260 006	532 260 006	532 278 006	532 278 006	532 278 006	532 218 006
Protective cap for coupler connector	536 910 606	536 910 606	536 910 606				
Housing for panel connector	536 935 006	536 935 006	536 935 006	536 937 006	536 937 006	536 937 006	536 996 006

Female panel connectors – Male cable connectors – Female coupler connectors

Square female panel connector	"536 603 006	"536 604 006	"536 606 006	"533 760 006	"536 608 006	"536 612 006	536 368 006
Male cable connector	532 653 006	532 654 006	532 656 006	530 754 006	532 658 006	532 662 006	532 368 006
Female coupler connector	"530 153 006	"530 154 006	"530 156 006	"530 753 006	"530 158 006	"530 162 006	530 167 006
Type 3 cable clamp	630 135 006	630 135 006	630 135 006	630 138 006	630 138 006	630 138 006	630 155 006
Flat-Gasket for panel connector (pack of 10)	536 945 006	536 945 006	536 945 006	536 946 006	536 946 006	536 946 006	536 947 006
Protective cap for panel connector	536 910 006	536 910 006	536 910 006	536 911 006	536 911 006	536 911 006	536 846 006
Protective cap for male cable connector	532 265 006	532 265 006	532 265 006	532 279 006	532 279 006	532 279 006	532 218 006
Protective cap for coupler connector	536 910 606	536 910 606	536 910 606				
Housing for panel connector	536 935 006	536 935 006	536 935 006	536 937 006	536 937 006	536 937 006	536 996 006

- For the version with 4 contacts ø 4 mm, contact No. 4 of the panel connector and the coupler connector, which makes the electrical connection before the other 3 contacts and disconnects it after separation, can be used as a ground contact.
- " Square female panel connectors and female coupler connectors are also of the „Standard“ type, page 10 with 3 to 12 contacts.
- " Square female panel connectors are also of the „Weatherproof“ type page 22 and the „Weatherproof PG“ type page 26 with 3 to 12 contacts.
- Sealable tamper-evident connectors for housings 1 and 2. See: Accessories.
- For assembly, wiring, panel connector installation and contact arrangement instructions, see: Technical guides.
- Other accessories, see: Accessories.

Technical Data

RoHS

Panel connector, cable connector and coupler connector

Panel connector



Cable connector



Coupler connector



Locking	rectangular housing screw up the knurled ring on the cable connector 1/6 of a turn on the panel connector barrel, for frequent locking and unlocking
Protection	IP 50 to IP 54 with conexil in the housing with flat-gasket for panel connector
Contacts	3 to 17 contacts \varnothing 2 mm – \varnothing 3 mm – \varnothing 4 mm non-removable solder contacts
Max. current	15 A \varnothing 2 mm – 35 A \varnothing 3 mm – 50 A \varnothing 4 mm
Contact resistance between pin and socket	< 1,5 m Ω \varnothing 2 mm – < 1 m Ω \varnothing 3 mm – < 0,7 m Ω \varnothing 4 mm
Breakdown voltage between adjacent contacts	> 2500 Volts (RMS)
Breakdown voltage between peripheral contacts and ground	> 1500 Volts (RMS), (> 2000 Volts (RMS) 4 contacts \varnothing 4mm)
Insulation resistance	> 10 ⁷ M Ω at 20 °C – > 10 ⁵ M Ω at 100 °C
Operating temperature	-40 °C to +100 °C (500 hours at +125 °C)
Materials	Nickel-plated light alloy, gold-plated brass contacts, PBT insert
Max. cross-section of soldered conductors	1,34 mm ² \varnothing 2 mm – 3,18 mm ² \varnothing 3 mm – 5,26 mm ² \varnothing 4 mm

Dimensional Data

Panel connector

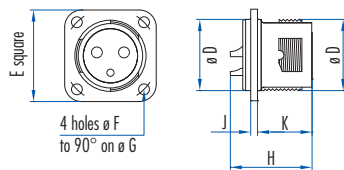

Cable connector

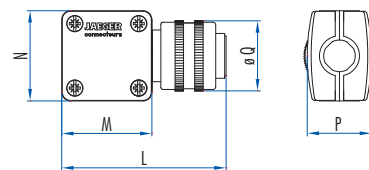

Coupler connector

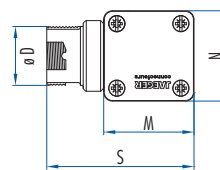

Cable connector – Panel connector assembly

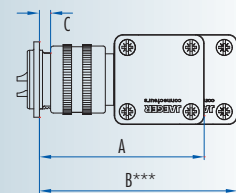

Housing	Number of Contacts	Assembly		Male panel connector										Female cable connector – Male coupler connector										Assembly		Female panel connector										Male cable connector – Female coupler connector									
		A	B	C	\varnothing D	E	\varnothing F	\varnothing G	H	J	K	L	M	N	P	\varnothing Q	S	A	B	C	\varnothing D	E	\varnothing F	\varnothing G	H	J	K	L	M	N	P	\varnothing Q	S												
1	3-4-6	64	73	4	21	27	3,2	28	24,8	2	12,5	57	32,2	32,2	20,2	25	51	65	76	4	21	27	3,2	28	25	2	16	57	32,2	32,2	20,2	25	51												
2	4	68	79	4	27	32	3,2	34	29	2	12,5	63	36,4	36,4	23,5	32	55	72	82	4	27	32	3,2	34	31	2	16	63	36,4	36,4	23,5	32	55												
2	8-12	68	79	4	27	32	3,2	34	24	2	12,5	63	36,4	36,4	23,5	32	55	72	82	4	27	32	3,2	34	24	2	16	63	36,4	36,4	23,5	32	55												
3	17	75	78	4	39	43	4,2	48	22,5	2	12,5	65	42,6	47,6	31,3	44	61	67	78	4	39	43	4,2	48	26	2	12	63	42,6	47,6	31,3	44	61												

*** B: minimum disconnection distance

Part Number

Housing	1	1	1	2	2	2	3
Number of Contacts	3	4	6	4	8	12	17
L ø 2 mm	1	4	6		6	12	15
L ø 3 mm	2				2		2
L ø 4 mm				4			

Male panel connectors – Female cable connectors – Male coupler connectors

Square male panel connector	536 353 006	536 354 006	536 356 006	533 755 006	536 358 006	536 362 006	536 357 006
Female cable connector	532 353 006	532 354 006	532 356 006	530 755 006	532 358 006	532 362 006	532 357 006
Male coupler connector	530 103 006	530 104 006	530 106 006	530 752 006	530 108 006	530 112 006	530 107 006
Type 3 cable clamp	630 135 006	630 135 006	630 135 006	630 138 006	630 138 006	630 138 006	630 155 006
Flat-Gasket for panel connector (pack of 10)	536 945 006	536 945 006	536 945 006	536 946 006	536 946 006	536 946 006	536 947 006
Protective cap for panel connector	536 910 006	536 910 006	536 910 006	536 911 006	536 911 006	536 911 006	536 846 006
Protective cap for female cable connector	532 260 006	532 260 006	532 260 006	532 278 006	532 278 006	532 278 006	532 218 006
Protective cap for coupler connector	536 910 606	536 910 606	536 910 606				
Gehäuse Gerüstestecker	536 935 006	536 935 006	536 935 006	536 937 006	536 937 006	536 937 006	536 996 006

Female panel connectors – Male cable connectors – Female coupler connectors

Square female panel connector	536 853 006	536 854 006	536 856 006	533 760 006	536 858 006	536 862 006	536 857 006
Male cable connector	532 853 006	532 854 006	532 856 006	530 754 006	532 858 006	532 862 006	532 857 006
Female coupler connector	530 183 006	530 184 006	530 186 006	530 753 006	530 188 006	530 192 006	530 187 006
Type 3 cable clamp	630 135 006	630 135 006	630 135 006	630 138 006	630 138 006	630 138 006	630 155 006
Flat-Gasket for panel connector (pack of 10)	536 945 006	536 945 006	536 945 006	536 946 006	536 946 006	536 946 006	536 947 006
Protective cap for panel connector	536 910 006	536 910 006	536 910 006	536 911 006	536 911 006	536 911 006	536 846 006
Protective cap for male cable connector	532 265 006	532 265 006	532 265 006	532 279 006	532 279 006	532 279 006	532 218 006
Protective cap for coupler connector	536 910 606	536 910 606	536 910 606				
Gehäuse Gerüstestecker	536 935 006	536 935 006	536 935 006	536 937 006	536 937 006	536 937 006	536 996 006

- For the version with 4 contacts ø 4 mm, contact No. 4 of the panel connector and the coupler connector, which makes the electrical connection before the other 3 contacts and disconnects it after separation, can be used as a ground contact.
- The square female panel connectors with 3 to 12 contacts can be mated with cable connectors from the „Standard“ Series page 10 and „Weatherproof“ Series page 22.
- Sealable tamper-evident connectors for housings 1 and 2. See: Accessories.
- For assembly, wiring, panel connector installation and contact arrangement instructions, see: Technical guides.
- Other accessories, see: Accessories.

Technical Data

RoHS

Panel connector and cable connector

Locking	Panel connector rectangular housing screw up the knurled ring on the cable connector 1/6 of a turn on the panel connector barrel, for frequent locking and unlocking
Protection	Cable connector IP 50 to IP 54 with conexil in the housing, flat-gasket for panel connector and cable connector seal
Contacts	single contact \varnothing 2 mm, non-removable solder contact
Max. current	15 A \varnothing 2 mm
Contact resistance between pin and socket	$< 1,5m \Omega \varnothing$ 2 mm
Maximum voltage in steady state	> 2500 Volts
Test voltage	6000 Volts (2U + 1000)
Insulation resistance	$> 10^6$ M Ω
Operating temperature	-20 °C to +100 °C (100 hours at +100 °C)
Materials	Nickel-plated light alloy, silver-plated brass contact, thermoplastic insert
Max. cross-section of soldered conductors	(shielded or unshielded high-voltage cable) 1,91 mm ² \varnothing 2 mm

Panel connector



Cable connector



Dimensional Data

Panel connector

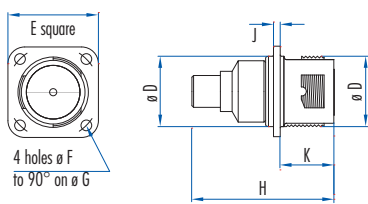

Cable connector

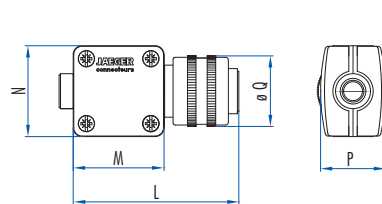

Cable connector – Panel connector assembly

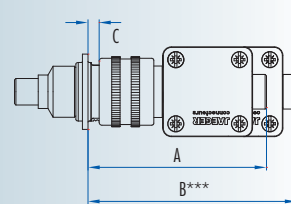

Housing	Number of Contacts	Assembly			Male panel connector							Female cable connector					Assembly			Female panel connector							Male cable connector				
		A	B	C	ø D	E	ø F	ø G	H	J	K	L	M	N	P	ø Q	A	B	C	ø D	E	ø F	ø G	H	J	K	L	M	N	P	ø Q
1	1	67	78	4	21	27	3,2	28	40	2	12,5	62	32,2	32,2	20,2	25	70	81	4	21	27	3,2	28	42	2	16	62	32,2	32,2	20,2	25

*** B: minimum disconnection distance

Part Number

Housing	1
Number of Contacts a 2 mm	1
Male panel connector – Female cable connector	
Square male panel connector	536 390 006
Female cable connector	532 390 006
Housing for panel connector	536 886 006
Flat-Gasket for panel connector (pack of 10)	536 945 006
Female panel connector – Male cable connector	
Square female panel connector	536 391 006
Male cable connector	532 391 006
Housing for panel connector	536 886 006
Flat-Gasket for panel connector (pack of 10)	536 945 006

- Sealable tamper-evident connectors for housings, see: Accessories.
- For wiring and panel connector installation instructions, see: Technical guides.

Preparing the cable

Warning: When the circuit is under load:

- do not separate the two parts of the connector
- do not fit or remove the protective caps on connectors
- Use shielded or unshielded high-voltage cables. Maximum cross-section of the conductor: 1,91 mm².
- To wire the panel connector, use a housing with cable clamp or the assembly shown below. A lug is delivered with the panel connector for the electrical continuity of the cable shielding, if necessary.
- To achieve the performances previously stated, the assembly instructions given on the diagram below must be strictly be followed.
- The polyethylene insulating sleeves must be fully inserted into their seating.

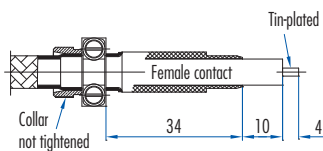

Cable connectors

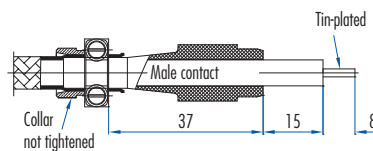
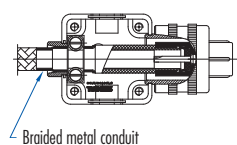

Panel connectors

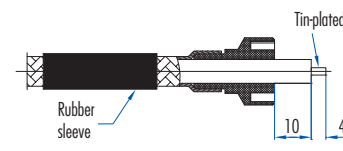
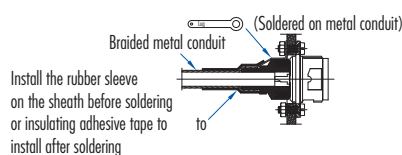

Technical Data

RoHS

Panel connector, cable connector and coupler connector

Panel connector



Cable connector



Coupler connector



Panel connector, cable connector and coupler connector	circular housing
Locking	screw connection
Protection	IP 65 with flat-gasket for panel connector
Contacts	3 to 52 contacts \varnothing 2 mm – \varnothing 3 mm – \varnothing 4 mm non-removable solder contacts
Max. current	15 A \varnothing 2 mm – 35 A \varnothing 3 mm – 50 A \varnothing 4 mm
Contact resistance between pin and socket	< 1,5 m Ω \varnothing 2 mm – < 1 m Ω \varnothing 3 mm – < 0,7 m Ω \varnothing 4 mm
Breakdown voltage between adjacent contacts	> 2500 Volts (RMS)
Breakdown voltage between peripheral contacts and ground	> 1500 Volts (RMS), (> 2000 Volts (RMS) 4 contacts \varnothing 4mm)
Insulation resistance	> 5000 M Ω
Operating temperature	-40 °C to 100 °C (500 hours at 125 °C)
Materials	Nickel-plated light alloy, silver-plated brass contact, PBT insert except contacts diameter 4 mm which are gold-plated brass
Max. cross-section of soldered conductors	1,34 mm ² \varnothing 2 mm – 3,18 mm ² \varnothing 3 mm – 5,26 mm ² \varnothing 4 mm

Dimensional Data

Panel connector

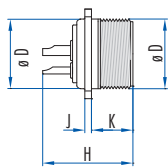
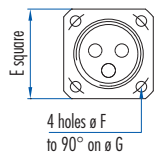

Circular male panel connectors housings 3 to 5

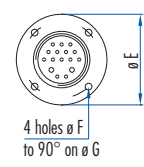

Circular male panel connectors housings 1 and 2

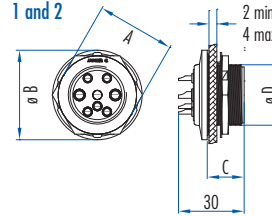

Panel connector + Cable connector assembly

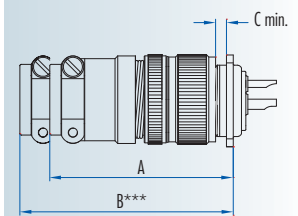

Female cable connector

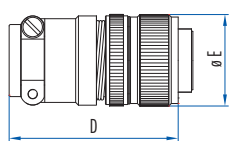

Male cable connector

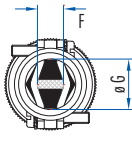
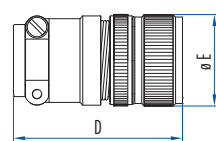

Male coupler connector

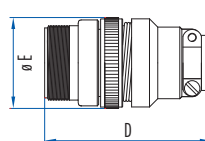

Housing	Number of Contacts	Square male panel connector							Male cable connector panel connector assembly	Male cable connector				Female cable connector panel connector assembly			Female cable connector				Male coupler connector				Circular male panel connector														
		\varnothing D	E	\varnothing F	\varnothing G	H	J	K		A	B	C	D	\varnothing E	\varnothing F	\varnothing G	D	\varnothing E	\varnothing F	\varnothing G	D	\varnothing E	\varnothing F	\varnothing G	A	\varnothing B	C	\varnothing D	\varnothing E	\varnothing F	\varnothing G								
1	3-4-6	21	27	3,2	28	24,8	2	12,5	58,5	69,5	4	52	26	7	10	55	67	4	52,5	26	7	10	53	25,5	7	10	29	34	16,5	M21									
2	4-8-12	27	32	3,2	34	29	2	12,5	66,5	77,5	4	59,5	33	9	13,5	61,5	73,5	4	59	33	9	13,5	61	32,5	9	13,5	35	40	16,5	M27									
3	17	39	43	4,2	48	22,5	2	12	76,5	87	4	69,5	44	12,5	17	70	81	4	66,5	44	12,5	17	69	43,5	12,5	17							57	4,2	48				
4	25	45	47	4,2	54	23,7	2	12	81,5	93	4	75,5	51	12,5	17	75	86	4	71,5	51	12,5	17	73	50	12,5	17							63	4,2	54				
5	35-52	52	54	4,2	62	28,7	2	12	87	96,5	4	79	58	16	23	77	88	4	73,5	58	16	23	78,5	56,5	16	23							72	4,2	62				
Housing	Number of Contacts	Square female panel connector							Male cable connector panel connector assembly	Male cable connector				Male cable connector panel connector assembly			Female cable connector				Male coupler connector				Circular male panel connector														
		\varnothing D	E	\varnothing F	\varnothing G	H	J	K		A	B	C	D	\varnothing E	\varnothing F	\varnothing G	A	B	C	D	\varnothing E	\varnothing F	\varnothing G	D	\varnothing E	\varnothing F	\varnothing G	A	\varnothing B	C	\varnothing D	\varnothing E	\varnothing F	\varnothing G					
1	3-4-6	21	27	3,2	28	25	2	16	60,5	69,5	4	53,5	26	9	12	56	68	4	49,5	26	9	12	54	25,5	9	12													
2	4-8-12	27	32	3,2	34	31	2	16	68,5	78,5	4	61,5	33	12,5	17	63,5	75,5	4	57,5	33	12,5	17	63	32,5	12,5	17													
3	17	39	43	4,2	48	26	2	18,5	78,5	90	4	72,5	44	16	23	73	84	4	67	44	16	23	72	43,5	16	23													
4	25	45	47	4,2	54	26	2	18,5	87,5	95,5	4	78	51	16	23	79	90	4	72,5	51	16	23	77	50	16	23													
5	35-52	52	54	4,2	62	26	2	18,5	91	100,5	4	83	58	22	32	81	92	4	78	58	22	32	82,5	58,5	22	32													

*** B: minimum disconnection distance

Part Number

Housing	1	1	1	2	2	2	3	4	5	5
Number of Contacts	3	4	6	4	8	12	17	25	35	52
L \varnothing 2 mm	1	4	6		6	12	15	23	33	52
L \varnothing 3 mm	2				2		2	2	2	
L \varnothing 4 mm				4						

Male panel connectors – Female cable connectors – Male coupler connectors

Circular male panel connector*	°536 753 006	°536 754 006	°536 756 006		°536 758 006	°536 762 006	°536 117 006	°536 125 006	°536 135 006	°533 706 006
Square male panel connector	°038 351 006	°043 082 006	°038 355 006	°533 763 006	°038 356 006	°038 359 006	°038 322 006	°042 986 006	°043 001 006	°533 703 006
Female cable connector + cable clamp, small outlet	532 401 006	532 402 006	532 403 006	532 763 006	532 404 006	532 405 006	532 406 006	532 407 006	532 408 006	530 713 006
Male coupler connector + cable clamp, small outlet	532 481 006	532 482 006	532 483 006	532 786 006	532 484 006	532 485 006	532 486 006	532 487 006	532 488 006	530 717 006
L Capacity of the cable clamp in mm	\varnothing 7 – 10	\varnothing 7 – 10	\varnothing 7 – 10	\varnothing 9 – 13,5	\varnothing 9 – 13,5	\varnothing 9 – 13,5	\varnothing 12,5 – 17	\varnothing 12,5 – 17	\varnothing 16 – 23	\varnothing 16 – 23
Female cable connector + cable clamp, large outlet	532 411 006	532 412 006	532 413 006	530 773 006	532 414 006	532 415 006	532 416 006	532 417 006	532 418 006	530 714 006
Male coupler connector + cable clamp, large outlet	532 471 006	532 472 006	532 473 006	530 776 006	532 474 006	532 475 006	532 476 006	532 477 006	532 478 006	530 718 006
L Capacity of the cable clamp in mm	\varnothing 9 – 12	\varnothing 9 – 12	\varnothing 9 – 12	\varnothing 12,5 – 17	\varnothing 12,5 – 17	\varnothing 12,5 – 17	\varnothing 16 – 23	\varnothing 16 – 23	\varnothing 22 – 32	\varnothing 22 – 32
Flat-Gasket for panel connector (pack of 10)	536 945 006	536 945 006	536 945 006	536 946 006	536 946 006	536 946 006	536 947 006	536 126 006	536 136 006	536 136 006
Protective cap for panel connector	536 910 006	536 910 006	536 910 006	536 911 006	536 911 006	536 911 006	536 912 006	536 913 006	536 914 006	536 914 006
Protective cap for female cable connector	532 270 006	532 270 006	532 270 006	532 271 006	532 271 006	532 271 006	532 262 206	532 268 206	532 269 206	532 269 206
Protective cap for coupler connector	536 910 756	536 910 756	536 910 756							

Female panel connectors – Male cable connectors

Square female panel connector	°536 603 006	°536 604 006	°536 606 006	°533 760 006	°536 608 006	°536 612 006	°536 617 006	°536 625 006	°536 635 006	°533 700 006
Male cable connector + cable clamp, small outlet	532 431 006	532 432 006	532 433 006	532 760 006	532 434 006	532 435 006	532 436 006	532 437 006	532 438 006	530 710 006
L Capacity of the cable clamp in mm	\varnothing 7 – 10	\varnothing 7 – 10	\varnothing 7 – 10	\varnothing 9 – 13,5	\varnothing 9 – 13,5	\varnothing 9 – 13,5	\varnothing 12,5 – 17	\varnothing 12,5 – 17	\varnothing 16 – 23	\varnothing 16 – 23
Male cable connector + cable clamp, large outlet	532 441 006	532 442 006	532 443 006	530 770 006	532 444 006	532 445 006	532 446 006	532 447 006	532 448 006	530 711 006
L Capacity of the cable clamp in mm	\varnothing 9 – 12	\varnothing 9 – 12	\varnothing 9 – 12	\varnothing 12,5 – 17	\varnothing 12,5 – 17	\varnothing 12,5 – 17	\varnothing 16 – 23	\varnothing 16 – 23	\varnothing 22 – 32	\varnothing 22 – 32
Flat-Gasket for panel connector (pack of 10)	536 945 006	536 945 006	536 945 006	536 946 006	536 946 006	536 946 006	536 947 006	536 126 006	536 136 006	536 136 006
Protective cap for panel connector	536 910 006	536 910 006	536 910 006	536 911 006	536 911 006	536 911 006	536 912 006	536 913 006	536 914 006	536 914 006
Protective cap for female cable connector	532 280 006	532 280 006	532 280 006	532 281 006	532 281 006	532 281 006	532 262 206	532 268 206	532 269 206	532 269 206
Protective cap for coupler connector	536 910 756	536 910 756	536 910 756							

- Moulded watertight rubber boots for cables are delivered with the connectors. They must be mounted in the cable connectors or coupler connectors.
- For the version with 4 contacts \varnothing 4 mm, contact No. 4 of the panel connector and the coupler connector, which makes the electrical connection before the other 3 contacts and disconnects it after separation, can be used as a ground contact.
- ° The panel connectors are also compatible with the „Standard cable connectors“ page 10 and „Weatherproof PG cable connectors“ page 26.
- ° Square female panel connectors are also of the „Rapid“ type, page 16 with 3 to 12 contacts.
- For assembly, wiring, panel connector installation and contact arrangement instructions, see: Technical guides;
- Other accessories, see: Accessories.
- * The circular male panel connector with 3 to 12 contacts includes a body, a seal, a nut and its locknut.

Technical Data

	Panel connector		Cable connector		Coupler connector	
Panel connector, cable connector and coupler connector	circular housing					
Locking	screw connection					
Protection	IP 65 with flat-gasket for panel connector					
Contacts	3 to 52 contacts \varnothing 2 mm – \varnothing 3 mm – \varnothing 4 mm non-removable solder contacts					
Max. current	15 A \varnothing 2 mm – 35 A \varnothing 3 mm – 50 A \varnothing 4 mm					
Contact resistance between pin and socket	$< 1,5 \text{ m}\Omega$ \varnothing 2 mm – $< 1 \text{ m}\Omega$ \varnothing 3 mm – $< 0,7 \text{ m}\Omega$ \varnothing 4 mm					
Tightness (only valid for circular panel connectors)	leak observed under a differential pressure of 2 bars: $< 15 \text{ cm}^3/\text{hour}$					
Breakdown voltage between adjacent contacts	> 2500 Volts (RMS)					
Breakdown voltage between peripheral contacts and ground	> 1500 Volts (RMS), (> 2000 Volts (RMS) 4 contacts \varnothing 4 mm)					
Insulation resistance	$> 5000 \text{ M}\Omega$					
Operating temperature	-40°C to $+100^\circ\text{C}$ (500 hours at $+125^\circ\text{C}$)					
Materials	Brass with olive-green cadmium surface treatment, gold-plated brass contacts, PBT insert					
Max. cross-section of soldered conductors	$1,34 \text{ mm}^2$ \varnothing 2 mm – $3,18 \text{ mm}^2$ \varnothing 3 mm – $5,26 \text{ mm}^2$ \varnothing 4 mm					

Dimensional Data

Square panel connector

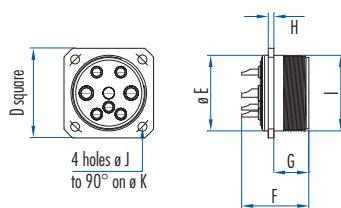

Circular male panel connectors housings 3 to 5

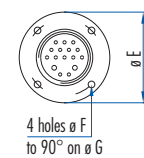

Circular male panel connectors housings 1 and 2

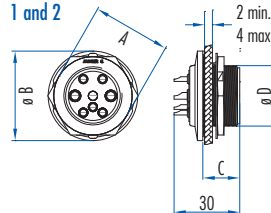

Cable connector

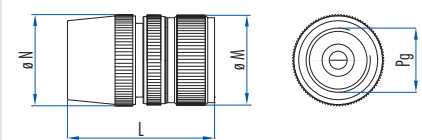

Coupler connector

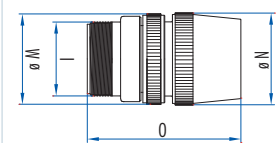

Housing	Number of Contacts	Assembly			Square male panel connector										Female cable connector Male coupler connector					Circular male panel connector						
		A	B	C	D	ø E	F	G	H	I	ø J	ø K	L	ø M	ø N	O	PG	A	ø B	C	ø D	ø E	ø F	ø G		
1	3-4-6	57,5	69	4	27	21	25,8	12,5	2	M21	3,2	28	55	26	25	51	11	29	34	16,5	M21					
2	4-8-12	61,5	73	4	32	27	24	12,5	2	M27	3,2	34	60	33	33,5	55,5	16	35	40	16,5	M27					
3	17	71	82	4	43	39	23,7	12	2	Tr39	4,2	48	65	44	44	65	21						57	4,2	48	
4	25	75	86	4	47	45	23,7	12	2	Tr45	4,2	54	69	51	52	75	29						63	4,2	54	
5	35-52	80	91	4	54	52	23,7	12	2	Tr52	4,2	62	74	58	58	77	36						72	4,2	62	

Housing	Number of Contacts	Assembly			Square female panel connector										Male cable connector			
		A	B	C	D	ø E	F	G	H	I	ø J	ø K	L	ø M	ø N	PG		
1	3-4-6	61	72	4	27	21	25	16	2	M21	3,2	28	54	26	25	11		
2	4-8-12	66,5	78	4	32	27	24	16	2	M27	3,2	34	58,5	33	33,5	16		
3	17	71,5	83	4	43	39	29,6	18,5	2	Tr39	4,2	48	65,5	44	44	21		
4	25	75,5	87	4	47	45	29,6	18,5	2	Tr45	4,2	54	69,5	51	52	29		
5	35-52	80,5	92	4	54	52	29,6	18,5	2	Tr52	4,2	62	71,5	58	58	36		

*** B: minimum disconnection distance

Square panel connector / Cable connector assembly

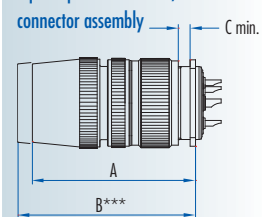

Part Number

Housing	1	1	1	2	2	2	3	4	5	5
Number of Contacts	3	4	6	4	8	12	17	25	35	52
L \varnothing 2 mm	1	4	6		6	12	15	23	33	52
L \varnothing 3 mm	2				2		2	2	2	
L \varnothing 4 mm				4						

Male panel connectors – Female cable connectors – Male coupler connectors

Circular male panel connector*	536 753 256	536 754 256	536 756 256		536 758 256	536 762 256	536 117 256	536 125 256	536 135 256	533 706 256
Square male panel connector	038 351 256	043 082 256	038 355 256	533 763 256	038 356 256	038 359 256	038 322 256	042 986 256	043 001 256	533 703 256
Female cable connector	633 401 256	633 402 256	633 403 256	633 410 256	633 404 256	633 405 256	633 406 256	633 407 256	633 408 256	633 409 256
Male coupler connector	633 481 256	633 482 256	633 483 256	633 490 256	633 484 256	633 485 256	633 486 256	633 487 256	633 488 256	633 489 256
PG	PG 11	PG 11	PG 11	PG 16	PG 16	PG 16	PG 21	PG 29	PG 36	PG 36
Cable clamp	633 421 256	633 421 256	633 421 256	633 422 256	633 422 256	633 422 256	633 423 256	633 424 256	633 425 256	633 425 256
L Capacity of the cable clamp in mm	\varnothing 7,5–12	\varnothing 7,5–12	\varnothing 7,5–12	\varnothing 9,8–17	\varnothing 9,8–17	\varnothing 9,8–17	\varnothing 15,5–23	\varnothing 15,8–24	\varnothing 19–32	\varnothing 19–32
Flat-Gasket for panel connector (pack of 10)	536 945 006	536 945 006	536 945 006	536 946 006	536 946 006	536 946 006	536 947 006	536 126 006	536 136 006	536 136 006
Protective cap for panel connector	536 910 256	536 910 256	536 910 256	536 911 256	536 911 256	536 911 256	536 912 256	536 913 256	536 914 256	536 914 256
Protective cap for female cable connector	532 270 256	532 270 256	532 270 256	532 271 256	532 271 256	532 271 256	532 262 256	532 268 256	532 269 256	532 269 256

Female panel connectors – Male cable connectors

Square female panel connector	536 603 256	536 604 256	536 606 256	533 760 256	536 608 256	536 612 256	536 617 256	536 625 256**	536 635 256**	533 700 256**
Male cable connector	633 431 256	633 432 256	633 433 256	633 440 256	633 434 256	633 435 256	633 436 256	633 437 256	633 438 256	633 439 256
PG	PG 11	PG 11	PG 11	PG 16	PG 16	PG 16	PG 21	PG 29	PG 36	PG 36
Cable clamp	633 421 256	633 421 256	633 421 256	633 422 256	633 422 256	633 422 256	633 423 256	633 424 256	633 425 256	633 425 256
L Capacity of the cable clamp in mm	\varnothing 7,5–12	\varnothing 7,5–12	\varnothing 7,5–12	\varnothing 9,8–17	\varnothing 9,8–17	\varnothing 9,8–17	\varnothing 15,5–23	\varnothing 15,8–24	\varnothing 19–32	\varnothing 19–32
Flat-Gasket for panel connector (pack of 10)	536 945 006	536 945 006	536 945 006	536 946 006	536 946 006	536 946 006	536 947 006	536 126 006	536 136 006	536 136 006
Protective cap for panel connector	536 910 256	536 910 256	536 910 256	536 911 256	536 911 256	536 911 256	536 912 256	536 913 256	536 914 256	536 914 256
Protective cap for male cable connector	532 280 256	532 280 256	532 280 256	532 281 256	532 281 256	532 281 256	532 262 256	532 268 256	532 269 256	532 269 256

- For the version with 4 contacts \varnothing 4 mm, contact No. 4 of the panel connector and the coupler connector, which makes the electrical connection before the other 3 contacts and disconnects it after separation, can be used as a ground contact.
- Moulded watertight rubber boots for cables are delivered with the connectors. They must be mounted in the cable connectors or coupler connectors.
- For assembly, wiring, panel connector installation and contact arrangement instructions, see: Technical guides.
- Other accessories, see: Accessories.
- * The circular male panel connector with 3 to 12 contacts includes a body, a seal, a nut and its locknut.

Technical Data

RoHS

Panel connector



Cable connector



Coupler connector



Panel connector, cable connector and coupler connector

circular housing

Locking

screw connection

Protection

IP 65 with flat-gasket for panel connector

Contacts

3 to 17 contacts \varnothing 2 mm – \varnothing 3 mm – \varnothing 4 mm non-removable solder contacts

Max. current

15 A \varnothing 2 mm – 35 A \varnothing 3 mm – 50 A \varnothing 4 mm

Contact resistance between pin and socket

$< 1,5 \text{ m}\Omega$ \varnothing 2 mm – $< 1 \text{ m}\Omega$ \varnothing 3 mm – $< 0,7 \text{ m}\Omega$ \varnothing 4 mm

Breakdown voltage between adjacent contacts

> 2500 Volts (RMS)

Breakdown voltage between peripheral contacts and ground

> 1500 Volts (RMS), (> 2000 Volts (RMS) 4 contacts \varnothing 4 mm)

Insulation resistance

$> 5000 \text{ M}\Omega$

Operating temperature

-40°C to $+100^\circ\text{C}$ (500 hours at $+125^\circ\text{C}$)

Materials

Nickel-plated light alloy, silver-plated brass contact, PBT insert except contacts diameter 4 mm which are gold-plated brass

Max. cross-section of soldered conductors

$1,34 \text{ mm}^2$ \varnothing 2 mm – $3,18 \text{ mm}^2$ \varnothing 3 mm – $5,26 \text{ mm}^2$ \varnothing 4 mm

Dimensional Data

Square panel connector

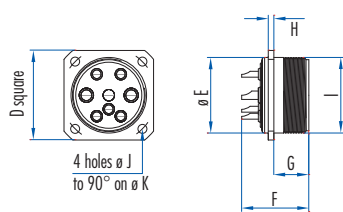

Cable connector

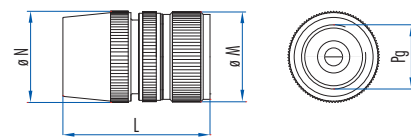

Circular male panel connectors housings 1 and 2

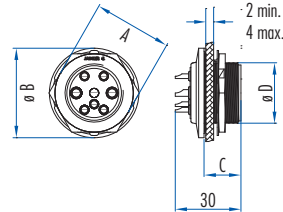

Coupler connector

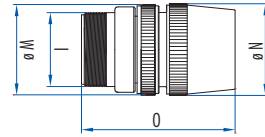

Circular male panel connectors housing 3

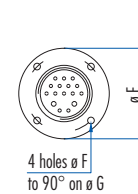

Square panel connector / Cable connector assembly

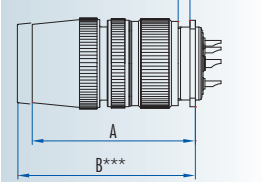

Housing	Number of Contacts	Assembly			Square male panel connector								Female cable connector – Male coupler connector					Circular male panel connector									
		A	B	C	D	ø E	F	G	H	I	ø J	ø K	L	ø M	ø N	O	PG	A	ø B	C	ø D	ø E	ø F	ø G			
1	3-4-6	57,5	69	4	27	21	25,8	12,5	2	M21	3,2	28	55	26	25	51	11	29	34	16,5	M21						
2	4-8-12	61,5	73	4	32	27	24	12,5	2	M27	3,2	34	60	33	33,5	55,5	16	35	40	16,5	M27						
3	17	71	82	4	43	39	23,7	12	2	Tr39	4,2	48	65	44	44	65	21						57	4,2	48		
Housing	Number of Contacts	Assembly			Square female panel connector								Male cable connector														
A	B	C	D	ø E	F	G	H	I	ø J	ø K	L	ø M	ø N	PG													
1	3-4-6	61	72	4	27	21	25	16	2	M21	3,2	28	54	26	25	11											
2	4-8-12	66,5	78	4	32	27	24	16	2	M27	3,2	34	58,5	33	33,5	16											
3	17	71,5	83	4	43	39	29,6	18,5	2	Tr39	4,2	48	65,5	44	44	21											

*** B: minimum disconnection distance

Part Number

Housing	1	1	1	2	2	2	3
Number of Contacts	3	4	6	4	8	12	17
L ø 2 mm	1	4	6		6	12	
L ø 3 mm	2				2		2
L ø 4 mm				4			

Male panel connectors – Female cable connectors – Male coupler connectors

Circular male panel connector*	°536 753 006	°536 754 006	°536 756 006		°536 758 006	°536 762 006	°536 117 006
Square male panel connector	°038 351 006	°043 082 006	°038 355 006	°533 763 006	°038 356 006	°038 359 006	°038 322 006
Female cable connector	633 401 006	633 402 006	633 403 006	633 410 006	633 404 006	633 405 006	633 406 006
Male coupler connector	633 481 006	633 482 006	633 483 006	633 490 006	633 484 006	633 485 006	633 486 006
PG	PG 11	PG 11	PG 11	PG 16	PG 16	PG 16	PG 21
Cable clamp	633 421 006	633 421 006	633 421 006	633 422 006	633 422 006	633 422 006	633 423 006
L Capacity of the cable clamp in mm	ø 7,5–12	ø 7,5–12	ø 7,5–12	ø 9,8–17	ø 9,8–17	ø 9,8–17	ø 15,5–23
Flat-Gasket for panel connector (pack of 10)	536 945 006	536 945 006	536 945 006	536 946 006	536 946 006	536 946 006	536 947 006
Protective cap for panel connector	536 910 006	536 910 006	536 910 006	536 911 006	536 911 006	536 911 006	536 912 006
Protective cap for female cable connector	532 270 006	532 270 006	532 270 006	532 271 006	532 271 006	532 271 006	532 262 006
Protective cap for coupler connector	536 910 756	536 910 756	536 910 756				

Female panel connectors – Male cable connectors

Square female panel connector	°536 603 006	°536 604 006	°536 606 006	°533 760 006	°536 608 006	°536 612 006	°536 617 006
Male cable connector	633 431 006	633 432 006	633 433 006	633 440 006	633 434 006	633 435 006	633 436 006
PG	PG 11	PG 11	PG 11	PG 16	PG 16	PG 16	PG 21
Cable clamp	633 421 006	633 421 006	633 421 006	633 422 006	633 422 006	633 422 006	633 423 006
L Capacity of the cable clamp in mm	ø 7,5–12	ø 7,5–12	ø 7,5–12	ø 9,8–17	ø 9,8–17	ø 9,8–17	ø 15,5–23
Flat-Gasket for panel connector (pack of 10)	536 945 006	536 945 006	536 945 006	536 946 006	536 946 006	536 946 006	536 947 006
Protective cap for panel connector	536 910 006	536 910 006	536 910 006	536 911 006	536 911 006	536 911 006	536 912 006
Protective cap for male cable connector	532 280 006	532 280 006	532 280 006	532 281 006	532 281 006	532 281 006	532 262 006
Protective cap for coupler connector	536 910 756	536 910 756	536 910 756				

- For the version with 4 contacts ø 4 mm, contact No. 4 of the panel connector and the coupler connector, which makes the electrical connection before the other 3 contacts and disconnects it after separation, can be used as a ground contact.
- ° The panel connectors are also compatible with the „Standard cable connectors“ page 10 and „Weatherproof cable connectors“ page 22.
- ° Square female panel connectors are also of the „Rapid“ type, page 16 with 3 to 12 contacts.
- Moulded watertight rubber boots for cables are delivered with the connectors. They must be mounted in the cable connectors or coupler connectors.
- For assembly, wiring, panel connector installation and contact arrangement instructions, see: Technical guides.
- Other accessories, see: Accessories.
- * The circular male panel connector with 3 to 12 contacts includes a body, a seal, a nut and its locknut.

Hermetic Series – Hermetic Standard: Panel connector attached by welding

Technical Data

RoHS

Male panel connector



Female cable connector



Female cable connector



Male panel connector	attached by welding		
Cable connector		rectangular housing	circular housing
Locking		screw connection	
Protection	Depending on the associated cable connector	IP 50 to IP 54 with elastomer in the housing, flat-gasket for panel connector	IP 65 with flat-gasket for panel connector
Contacts	3 to 52 contacts \varnothing 2 mm, \varnothing 3 mm and/or \varnothing 4 mm, non-removable solder contacts		
Max. current	7 A \varnothing 2 mm – 12 A \varnothing 3 mm – 20 A \varnothing 4 mm		
Helium leak rate	$< 10^{-9}$ Atm.cm ³ /sec		
Permissible constant pressure difference between the two surfaces	50 bars, maximum test pressure: 150 bars		
Contact resistance	< 4 m Ω \varnothing 2 mm – < 3 m Ω \varnothing 3 mm – $< 1,5$ m Ω \varnothing 4 mm		
Insulation resistance	> 10000 M Ω		
Breakdown voltage between adjacent contacts	> 1500 Volts (RMS) at a pressure of ~ 100 Pa (according to Paschen's law)		
Operating temperature	-50 °C to +125 °C (500 hours at +150 °C)		-40 °C to +100 °C (500 hours at +125 °C)
Materials	Gold-plated steel body, gold-plated Dilver P contacts, sintered glass insulation between pins and body guaranteeing excellent mechanical resistance		Nickel-plated light alloy, silver-plated brass contacts, silver-plated PBT insert, PBT + resin insert
Max. cross-section of soldered conductors	1,34 mm ² \varnothing 2 mm (16AWG) – 3,18 mm ² \varnothing 3 mm (12AWG) – 5,26 mm ² \varnothing 4 mm (10 AWG)		

Dimensional Data

Panel connector

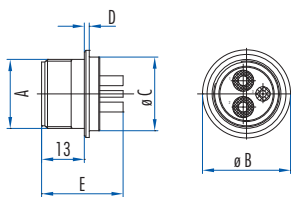

Housing	Number of Contacts	Male panel connector				
		A	\varnothing B	\varnothing C	D	E
1	3-4-6	M21	27	23	1,5	24
2	4	M27	33	29	1,5	29
2	8-12	M27	33	29	1,5	24
3	17	Tr39	43	39	2	23,5
4	25	Tr45	49	45	2	23,5
5	35-52	Tr52	56	52	2	23,5

Hermetic Series – Hermetic Standard: Panel connector attached by welding

Part Number

Housing	1	1	1	2	2	2	3	4	5	5
Number of Contacts	3	4	6	4	8	12	17	25	35	52
L \varnothing 2 mm	1	4	6		6	12	15	23	33	52
L \varnothing 3 mm	2				2		2	2	2	
L \varnothing 4 mm				4						

Male panel connectors attached by welding

Circular male panel connector	536 203 006	536 204 006	536 206 006	536 214 006	536 208 006	536 212 006	536 217 006	536 225 006	536 235 006	536 252 006
Protective cap for panel connector	536 910 006	536 910 006	536 910 006	536 911 006	536 911 006	536 911 006	536 912 006	536 913 006	536 914 006	536 914 006

The electrical connection is made using a cable connector from our „Standard“ or „Weatherproof“ Series. Select the most appropriate type of cable connector to suit your operating conditions.

Standard Series – Female cable connector (see page 10)



Female cable connector	042 953 006	043 085 006	042 954 006	530 763 006	042 955 006	042 956 006	038 382 006	042 977 006	042 990 006	530 703 006
Type 3 cable clamp	630 135 006	630 135 006	630 135 006	630 138 006	630 138 006	630 138 006	630 155 006	630 155 006	630 175 006	630 175 006
Protective cap for female cable connector	532 260 006	532 260 006	532 260 006	532 278 006	532 278 006	532 278 006	532 262 006	532 268 006	532 269 006	532 269 006

Weatherproof Series – Female cable connector (see page 22)

Female cable connector + cable clamp, small outlet	532 401 006	532 402 006	532 403 006		532 404 006	532 405 006	532 406 006	532 407 006	532 408 006	530 713 006
L Capacity of the cable clamp in mm	\varnothing 7 – 10	\varnothing 7 – 10	\varnothing 7 – 10		\varnothing 9 – 13	\varnothing 9 – 13	\varnothing 12,5 – 17	\varnothing 12,5 – 17	\varnothing 16 – 23	\varnothing 16 – 23
Female cable connector + cable clamp, large outlet	532 411 006	532 412 006	532 413 006	530 773 006	532 414 006	532 415 006	532 416 006	532 417 006	532 418 006	530 714 006
L Capacity of the cable clamp in mm	\varnothing 9 – 12	\varnothing 9 – 12	\varnothing 9 – 12	\varnothing 12,5 – 17	\varnothing 12,5 – 17	\varnothing 12,5 – 17	\varnothing 16 – 23	\varnothing 16 – 23	\varnothing 22 – 32	\varnothing 22 – 32
Protective cap for female cable connector	532 270 006	532 270 006	532 270 006	532 271 006	532 271 006	532 271 006	532 262 006	532 268 006	532 269 006	532 269 006

- The panel connectors can also be connected with the female cable connector from the Weatherproof High-Performance PG Series, and the female cable connector from the Weatherproof PG Series.
- Panel connector and conductors attached by tin soldering. Select the type of soldering according to the operating temperature. Avoid thermal shocks during soldering.
- For assembly, wiring, panel connector installation and contact arrangement instructions, see: Technical guides.
- Other accessories, see: Accessories.

Hermetic Series – Hermetic Standard: Panel connector attached by locknut

Technical Data		Standard Series	Weatherproof Series
RoHS	Male panel connector	Female cable connector	Female cable connector
			
Male panel connector	attached by locknut		
Cable connector		rectangular housing	circular housing
Locking		screw connection	
Protection	Depending on the associated cable connector	IP 50 to IP 54 with elastomer in the housing, flat-gasket for panel connector	IP 65 with flat-gasket for panel connector
Contacts	3 to 52 contacts \varnothing 2 mm, \varnothing 3 mm and/or \varnothing 4 mm, non-removable solder contacts		
Max. current	7 A \varnothing 2 mm – 12 A \varnothing 3 mm – 20 A \varnothing 4 mm		
Helium leak rate	< 10^{-9} Atm.cm ³ /sec		
Permissible constant pressure difference between the two surfaces	50 bars, maximum test pressure: 150 bars		
Contact resistance	< 4 m Ω \varnothing 2 mm – < 3 m Ω \varnothing 3 mm – < 1,5 m Ω \varnothing 4 mm		
Insulation resistance	> 10000 M Ω		
Breakdown voltage between adjacent contacts	> 1500 Volts (RMS) at a pressure of ~ 100Pa (according to Paschen's law)		
Operating temperature	-25 °C to +100 °C (500 hours at +125 °C)		
Materials	316L stainless steel body, Dilver P contacts, sintered glass insulation between pins and body guaranteeing excellent mechanical resistance		Nickel-plated light alloy, silver-plated brass contacts PBT insert except 4 mm diameter contacts which are gold-plated bras
Max. cross-section of soldered conductors	1,34 mm ² \varnothing 2 mm (16AWG) – 3,18 mm ² \varnothing 3 mm (12AWG) – 5,26 mm ² \varnothing 4 mm (10AWG)		

Dimensional Data

Panel connector

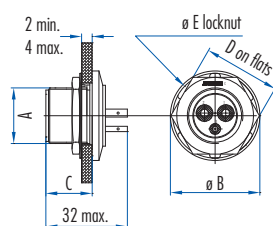

Housing	Number of Contacts	Male panel connector				
		A	ø B	C	D	ø E
1	3-4-6	M21	33,8	17,5	29	32
2	4-8-12	M27	39,8	17,5	35	38
3	17	Tr39	56	24,5	50	-
4	25	Tr45	62	24,5	60	-
5	35-52	Tr52	69	24,5	65	-

Hermetic Series – Hermetic Standard: Panel connector attached by locknut

Part Number

Housing	1	1	1	2	2	2	3	4	5	5
Number of Contacts	3	4	6	4	8	12	17	25	35	52
L \varnothing 2 mm	1	4	6		6	12	15	23	33	52
L \varnothing 3 mm	2				2		2	2	2	
L \varnothing 4 mm				4						

Male panel connectors attached by locknut

Complete male panel connector*	536 403 006	536 404 006	536 406 006	536 414 006	536 408 006	536 412 006	536 417 006	536 425 006	536 435 006	536 452 006
Protective cap for panel connector	536 910 006	536 910 006	536 910 006	536 911 006	536 911 006	536 911 006	536 912 006	536 913 006	536 914 006	536 914 006
Accessory for replacement										
L Seal	536 440 006	536 440 006	536 440 006	536 441 006	536 441 006	536 441 006	536 442 006	536 451 006	536 454 006	536 454 006
L Nut	536 446 006	536 446 006	536 446 006	536 447 006	536 447 006	536 447 006	536 448 006	536 450 006	536 453 006	536 453 006
L Locknut	536 443 006	536 443 006	536 443 006	536 444 006	536 444 006	536 444 006				

The electrical connection is made using a cable connector from our „Standard“ or „Weatherproof“ Series. Select the most appropriate type of cable connector to suit your operating conditions.

Standard Series – Female cable connector (see page 10)



Female cable connector	042 953 006	043 085 006	042 954 006	530 763 006	042 955 006	042 956 006	038 382 006	042 977 006	042 990 006	530 703 006
Type 3 cable clamp	630 135 006	630 135 006	630 135 006	630 138 006	630 138 006	630 138 006	630 155 006	630 155 006	630 175 006	630 175 006
Protective cap for female cable connector	532 260 006	532 260 006	532 260 006	532 278 006	532 278 006	532 278 006	532 262 006	532 268 006	532 269 006	532 269 006

Weatherproof Series – Female cable connector (see page 22)

Female cable connector + cable clamp, small outlet	532 401 006	532 402 006	532 403 006		532 404 006	532 405 006	532 406 006	532 407 006	532 408 006	530 713 006
L Capacity of the cable clamp in mm	\varnothing 7 – 10	\varnothing 7 – 10	\varnothing 7 – 10		\varnothing 9 – 13	\varnothing 9 – 13	\varnothing 12,5 – 17	\varnothing 12,5 – 17	\varnothing 16 – 23	\varnothing 16 – 23
Female cable connector + cable clamp, large outlet	532 411 006	532 412 006	532 413 006	530 773 006	532 414 006	532 415 006	532 416 006	532 417 006	532 418 006	530 714 006
L Capacity of the cable clamp in mm	\varnothing 9 – 12	\varnothing 9 – 12	\varnothing 9 – 12	\varnothing 12,5 – 17	\varnothing 12,5 – 17	\varnothing 12,5 – 17	\varnothing 16 – 23	\varnothing 16 – 23	\varnothing 22 – 32	\varnothing 22 – 32
Protective cap for female cable connector	532 270 006	532 270 006	532 270 006	532 271 006	532 271 006	532 271 006	532 262 006	532 268 006	532 269 006	532 269 006

- The panel connectors can also be connected with the female cable connector from the Weatherproof High-Performance PG Series, and the female cable connector from the Weatherproof PG Series.
- * The complete panel connector includes: a threaded metal body, with an immobilisation pin, pins that are attached and insulated by sintered glass beads, a synthetic rubber O-ring, a fastening nut locked by a washer (housings 1 and 2).
- For assembly, wiring, panel connector installation and contact arrangement instructions, see: Technical guides.
- Other accessories, see: Accessories.

Hermetic Series – Hermetic Standard: Bulkhead connector attached by locknut

Technical Data		Standard Series	Weatherproof Series
RoHS	 <p>Bulkhead connector Male → ← Male</p>	 <p>Female cable connector</p>	 <p>Female cable connector</p>
Male panel connector	attached by locknut		
Cable connector		rectangular housing	circular housing
Locking		screw connection	
Protection	Depending on the associated cable connector	IP 50 to IP 54 with elastomer in the housing, flat-gasket for panel connector	IP 65 with flat-gasket for panel connector
Contacts	3 to 52 contacts \varnothing 2 mm, \varnothing 3 mm, non-removable solder contacts		
Max. current	7 A \varnothing 2 mm – 12 A \varnothing 3 mm		
Helium leak rate	$< 10^{-9}$ Atm.cm ³ /sec		
Permissible constant pressure difference between the two surfaces	50 bars, maximum test pressure: 150 bars		
Contact resistance	> 5000 M Ω		
Insulation resistance	> 10000 M Ω		
Breakdown voltage between adjacent contacts	> 1500 Volts (RMS) at a pressure of ~ 100 Pa (according to Paschen's law)		
Operating temperature	-25 °C to +100 °C (500 hours at +125 °C)	-40 °C to +100 °C (500 hours at +125 °C)	
Materials	316L stainless steel body, Dilver P contacts, sintered glass insulation between pins and body guaranteeing excellent mechanical resistance	Nickel-plated light alloy, silver-plated brass contacts, PBT insert except 4 mm diameter contacts which are gold-plated brass	
Max. cross-section of soldered conductors	1,34 mm ² \varnothing 2 mm (16AWG) – 3,18 mm ² \varnothing 3 mm (12AWG)		

Dimensional Data

Bulkhead connector

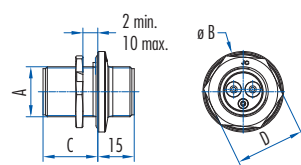

Housing	Number of Contacts	Bulkhead connector			
		A	\varnothing B	C	D
1	3-4-6	M21	33,8	23	29
2	8-12	M27	39,8	23	35
3	17	Tr39	56	24,5	50
4	25	Tr45	62	24,5	62
5	35-52	Tr52	69	24,5	65

Hermetic Series – Hermetic Standard: Bulkhead connector attached by locknut
Part Number

Housing	1	1	1	2	2	3	4	5	5
Number of Contacts	3	4	6	8	12	17	25	35	52
L \varnothing 2 mm	1	4	6	6	12	15	23	33	52
L \varnothing 3 mm	2			2		2	2	2	

Bulkhead connector male contacts attached by locknut

Complete male bulkhead connector*	533 103 006	533 104 006	533 106 006	533 108 006	533 112 006	533 117 006	533 125 006	533 135 006	533 152 006
Protective cap for panel connector	536 910 006	536 910 006	536 910 006	536 911 006	536 911 006	536 912 006	536 913 006	536 914 006	536 914 006
Accessory for replacement									
L Seal	536 440 006	536 440 006	536 440 006	536 441 006	536 441 006	536 442 006	536 451 006	536 454 006	536 454 006
L Nut	536 446 006	536 446 006	536 446 006	536 447 006	536 447 006	536 448 006	536 450 006	536 453 006	536 453 006
L Locknut	536 443 006	536 443 006	536 443 006	536 444 006	536 444 006				

The electrical connection is made using a cable connector from our „Standard“ or „Weatherproof“ Series. Select the most appropriate type of cable connector to suit your operating conditions.

Standard Series – Female cable connector (see page 10)

Female cable connector	042 953 006	043 085 006	042 954 006	042 955 006	042 956 006	038 382 006	042 977 006	042 990 006	530 703 006
Type 3 cable clamp	630 135 006	630 135 006	630 135 006	630 138 006	630 138 006	630 155 006	630 155 006	630 175 006	630 175 006
Protective cap for female cable connector	532 260 006	532 260 006	532 260 006	532 278 006	532 278 006	532 262 006	532 268 006	532 269 006	532 269 006

Weatherproof Series – Female cable connector (see page 22)



Female cable connector + cable clamp, small outlet	532 401 006	532 402 006	532 403 006	532 404 006	532 405 006	532 406 006	532 407 006	532 408 006	530 713 006
L Capacity of the cable clamp in mm	\varnothing 7 – 10	\varnothing 7 – 10	\varnothing 7 – 10	\varnothing 9 – 13	\varnothing 9 – 13	\varnothing 12,5 – 17	\varnothing 12,5 – 17	\varnothing 16 – 23	\varnothing 16 – 23
Female cable connector + cable clamp, large outlet	532 411 006	532 412 006	532 413 006	532 414 006	532 415 006	532 416 006	532 417 006	532 418 006	530 714 006
L Capacity of the cable clamp in mm	\varnothing 9 – 12	\varnothing 9 – 12	\varnothing 9 – 12	\varnothing 12,5 – 17	\varnothing 12,5 – 17	\varnothing 16 – 23	\varnothing 16 – 23	\varnothing 22 – 32	\varnothing 22 – 32
Protective cap for female cable connector	532 270 006	532 270 006	532 270 006	532 271 006	532 271 006	532 262 006	532 268 006	532 269 006	532 269 006

- The panel connectors can also be connected with the female cable connector from the Weatherproof High-Performance PG Series, and the female cable connector from the Weatherproof PG Series.

- * The complete bulkhead connector includes: a threaded metal body, with an immobilisation pin, pins that are attached and insulated by sintered glass beads, a synthetic rubber O-ring, a fastening nut locked by a washer (housings 1 and 2).

- For assembly, wiring, panel connector installation and contact arrangement instructions, see: Technical guides.

- Other accessories, see: Accessories.

Technical Data		Standard Series	Weatherproof Series
RoHS	Male panel connector	Female cable connector	Female cable connector
			
Male panel connector	attachment by Pneurop collars or flanges	rectangular housing	circular housing
Cable connector		screw connection	
Locking			
Protection	Depending on the associated cable connector	IP 50 to IP 54 with elastomer in the housing, flat-gasket for panel connector	IP 65 with flat-gasket for panel connector
Contacts	3 to 52 contacts ø 2 mm, ø 3 mm and/or ø 4 mm, non-removable solder contacts		
Max. current	7A ø 2 mm – 12A ø 3 mm – 20A ø 4 mm		
Helium leak rate	< 10 ⁻⁹ Atm. cm ³ /sec		
Permissible constant pressure difference between the two surfaces	50 bars, maximum test pressure: 150 bars		
Contact resistance	< 4 mΩ ø 2 mm – < 3 mΩ ø 3 mm – < 1,5 mΩ ø 4 mm		
Insulation resistance	> 10000 MΩ		
Breakdown voltage between adjacent contacts	> 1500 Volts (RMS) at a pressure of ~ 100Pa (according to Paschen's law)		
Operating temperature	-25 °C to +100 °C (500 hours at +125 °C)		
Materials	316L stainless steel body, Dilver P contacts, sintered glass insulation between pins and body guaranteeing excellent mechanical resistance		
	Nickel-plated light alloy, silver-plated brass contacts, PBT insert except 4 mm diameter contacts which are gold-plated brass		
Max. cross-section of soldered conductors	1,34 mm ² ø 2 mm (16AWG) – 3,18 mm ² ø 3 mm (12AWG) – 5,26 mm ² ø 4 mm (10AWG)		

Dimensional Data (in accordance with NF E 29 – 724)

Panel connector

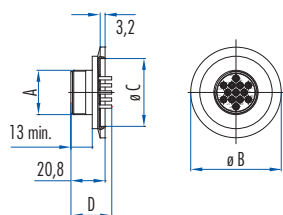

Housing	Number of Contacts	Male panel connector	A	ø B	ø C	D
1	3-4-6	M21	30	17,2	25	
2	4	M27	40	26,2	31	
2	8-12	M27	55	41,2	25	
3	17	Tr39	55	41,2	24	
4	25	Tr45	75	52,2	25	
5	35-52	Tr52	75	52,2	25	

Part Number

Housing	1	1	1	2	2	2	3	4	5	5
Number of Contacts	3	4	6	4	8	12	17	25	35	52
L \varnothing 2 mm	1	4	6		6	12	15	23	33	52
L \varnothing 3 mm	2				2		2	2	2	
L \varnothing 4 mm				4						
DN	16	16	16	25	25	40	40	50	50	50

Male panel connectors attached by flanges

Circulaire male panel connector	216 003 006	216 004 006	216 006 006	225 014 006	225 008 006	240 012 006	240 017 006	250 025 006	250 035 006	250 052 006
Protective cap for panel connector	536 910 006	536 910 006	536 910 006	536 911 006	536 911 006	536 911 006	536 912 006	536 913 006	536 914 006	536 914 006

The electrical connection is made using a cable connector from our „Standard“ or „Weatherproof“ Series. Select the most appropriate type of cable connector to suit your operating conditions.



Standard Series – Female cable connector (see page 10)

Female cable connector	042 953 006	043 085 006	042 954 006	530 763 006	042 955 006	042 956 006	038 382 006	042 977 006	042 990 006	530 703 006
Type 3 cable clamp	630 135 006	630 135 006	630 135 006	630 138 006	630 138 006	630 138 006	630 155 006	630 155 006	630 175 006	630 175 006
Protective cap for female cable connector	532 260 006	532 260 006	532 260 006	532 278 006	532 278 006	532 278 006	532 262 006	532 268 006	532 269 006	532 269 006

Weatherproof Series – Female cable connector (see page 22)

Female cable connector + cable clamp, small outlet	532 401 006	532 402 006	532 403 006		532 404 006	532 405 006	532 406 006	532 407 006	532 408 006	530 713 006
L Capacity of the cable clamp in mm	\varnothing 7 – 10	\varnothing 7 – 10	\varnothing 7 – 10		\varnothing 9 – 13	\varnothing 9 – 13	\varnothing 12,5 – 17	\varnothing 12,5 – 17	\varnothing 16 – 23	\varnothing 16 – 23
Female cable connector + cable clamp, large outlet	532 411 006	532 412 006	532 413 006	530 773 006	532 414 006	532 415 006	532 416 006	532 417 006	532 418 006	530 714 006
L Capacity of the cable clamp in mm	\varnothing 9 – 12	\varnothing 9 – 12	\varnothing 9 – 12		\varnothing 12,5 – 17	\varnothing 12,5 – 17	\varnothing 16 – 23	\varnothing 16 – 23	\varnothing 22 – 32	\varnothing 22 – 32
Protective cap for female cable connector	532 270 006	532 270 006	532 270 006	532 271 006	532 271 006	532 271 006	532 262 006	532 268 006	532 269 006	532 269 006

- The panel connectors can also be connected with the female cable connector from the Weatherproof High-Performance PG Series, and the female cable connector from the Weatherproof PG Series.
- Conductors attached by tin soldering. Select the type of soldering according to the operating temperature. Avoid thermal shocks during soldering.
- Other panel connectors with flanges of the ISO K or ISO F type are available by request. Consult our sales department.
- For assembly, wiring, panel connector installation and contact arrangement instructions, see: Technical guides.
- Other accessories, see: Accessories.

Technical Data		Standard Series	Weatherproof Series
RoHS	Male panel connector	Female cable connector	Female cable connector
			
Male panel connector	attachment by bolts		
Cable connector		rectangular housing	circular housing
Locking		screw connection	
Protection	Depending on the associated cable connector	IP 50 to IP 54 with elastomer in the housing, flat-gasket for panel connector	IP 65 with flat-gasket for panel connector
Contacts	3 to 52 contacts \varnothing 2 mm, \varnothing 3 mm and/or \varnothing 4 mm, non-removable solder contacts		
Max. current	7 A \varnothing 2 mm – 12 A \varnothing 3 mm – 20 A \varnothing 4 mm		
Helium leak rate	< 10 ⁻⁹ Atm.cm ³ /sec		
Permissible constant pressure difference between the two surfaces	50 bars, maximum test pressure: 150 bars		
Contact resistance	< 4 m Ω \varnothing 2 mm – < 3 m Ω \varnothing 3 mm – < 1,5 m Ω \varnothing 4 mm		
Insulation resistance	> 10000 M Ω		
Breakdown voltage between adjacent contacts	> 1500 Volts (RMS) at a pressure of ~ 100Pa (according to Paschen's law)		
Operating temperature	-50 °C to +125 °C (500 hours at +150 °C)		
Materials	316L stainless steel body, Dilver P contacts, sintered glass insulation between pins and body guaranteeing excellent mechanical resistance		
Max. cross-section of soldered conductors	1,34 mm ² \varnothing 2 mm (16AWG) – 3,18 mm ² \varnothing 3 mm (12AWG) – 5,26 mm ² \varnothing 4 mm (10AWG)		

Dimensional Data (in accordance with NF E 29 – 724)

Panel connector

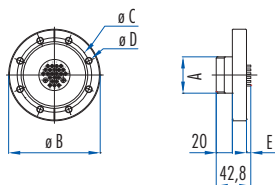

Housing	Number of Contacts	Male panel connector				
		A	$\varnothing B$	$\varnothing C$	$\varnothing D$	E
1	3-4-6	M21	70	58,7	6,6	13
2	4-8-12	M27	70	58,7	6,6	13
3	17	Tr39	70	58,7	6,6	13
4	25	Tr45	114	92,1	8,4	17,5
5	35-52	Tr52	114	92,1	8,4	17,5

Part Number

Housing	1	1	1	2	2	2	3	4	5	5
Number of Contacts	3	4	6	4	8	12	17	25	35	52
L \varnothing 2 mm	1	4	6		6	12	15	23	33	52
L \varnothing 3 mm	2				2		2	2	2	
L \varnothing 4 mm				4						
DN	40	40	40	40	40	40	40	63	63	63

Male panel connectors attached by bolts

Circular male panel connector	340 003 006	340 004 006	340 006 006	340 014 006	340 008 006	340 012 006	340 017 006	363 025 006	363 035 006	363 052 006
No. of attachment bolts (not supplied)	6	6	6	6	6	6	6	8	8	8
Protective cap for panel connector	536 910 006	536 910 006	536 910 006	536 911 006	536 911 006	536 911 006	536 912 006	536 913 006	536 914 006	536 914 006

The electrical connection is made using a cable connector from our „Standard“ or „Weatherproof“ Series. Select the most appropriate type of cable connector to suit your operating conditions.

Standard Series – Female cable connector (see page 10)

Female cable connector	042 953 006	043 085 006	042 954 006	530 763 006	042 955 006	042 956 006	038 382 006	042 977 006	042 990 006	530 703 006
Type 3 cable clamp	630 135 006	630 135 006	630 135 006	630 138 006	630 138 006	630 138 006	630 155 006	630 155 006	630 175 006	630 175 006
Protective cap for female cable connector	532 260 006	532 260 006	532 260 006	532 278 006	532 278 006	532 278 006	532 262 006	532 268 006	532 269 006	532 269 006

Weatherproof Series – Female cable connector (see page 22)

Female cable connector + cable clamp, small outlet	532 401 006	532 402 006	532 403 006		532 404 006	532 405 006	532 406 006	532 407 006	532 408 006	530 713 006
L Capacity of the cable clamp in mm	\varnothing 7 – 10	\varnothing 7 – 10	\varnothing 7 – 10		\varnothing 9 – 13	\varnothing 9 – 13	\varnothing 12,5 – 17	\varnothing 12,5 – 17	\varnothing 16 – 23	\varnothing 16 – 23
Female cable connector + cable clamp, large outlet	532 411 006	532 412 006	532 413 006	530 773 006	532 414 006	532 415 006	532 416 006	532 417 006	532 418 006	530 714 006
L Capacity of the cable clamp in mm	\varnothing 9 – 12	\varnothing 9 – 12	\varnothing 9 – 12		\varnothing 12,5 – 17	\varnothing 12,5 – 17	\varnothing 16 – 23	\varnothing 16 – 23	\varnothing 22 – 32	\varnothing 22 – 32
Protective cap for female cable connector	532 270 006	532 270 006	532 270 006	532 271 006	532 271 006	532 271 006	532 262 006	532 268 006	532 269 006	532 269 006

- The panel connectors can also be connected with the female cable connector from the Weatherproof High-Performance PG Series, and the female cable connector from the Weatherproof PG Series.
- Conductors attached by tin soldering. Select the type of soldering according to the operating temperature. Avoid thermal shocks during soldering.
- For assembly, wiring, panel connector installation and contact arrangement instructions, see: Technical guides.
- Other accessories, see: Accessories.

Technical Data

Natto Miniature Push-Pull Series

RoHS

Male panel connector

Cable connector

Locking

Protection

Contacts

Max. current

Mechanical endurance

Helium leak rate

Permissible constant pressure difference
between the two surfaces

Contact resistance

Insulation resistance

Breakdown voltage between adjacent contacts

Operating temperature

Materials

Male panel connector



attached by locknut

Female cable connector



circular housing

Push-Pull, for very frequent locking and unlocking

IP 65 with flat-gasket for panel connector

3 to 7 contacts \varnothing 1 mm,
removable solder or crimp contacts

3 to 7 contacts \varnothing 1 mm,
non-removable solder contacts

5 A \varnothing 1 mm

50000 locking and mating cycles

$< 10^{-9}$ Atm.cm³/sec

50 bars, maximum test pressure: 150 bars

< 10 m Ω \varnothing 1 mm

> 10000 M Ω

> 350 Volts (RMS)

-25 °C to +125 °C (500 hours at +150 °C)

Nickel-plated steel body, gold-plated Diver P
contacts, sintered glass insulation between pins
and body guaranteeing excellent mechanical
resistance

-40 °C to +100 °C (500 hours at +125 °C)

Nickel-plated light alloy, silver-plated brass contacts,
PBT insert

Max. soldered conductor cross-section

0,93 mm² \varnothing 1 mm (18AWG)

Dimensional Data

Panel connector

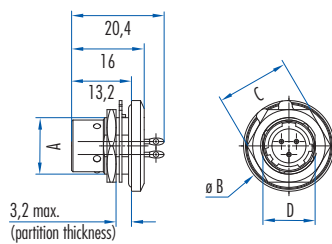

Housing	Number of Contacts	Male panel connector			
		\varnothing A	\varnothing B	\varnothing C	\varnothing D
00	3	M12,5	20	16	11,6
0	7	M16	23	19	15,1

Part Number

Housing	00	0
Number of Contacts ø 1 mm	3	7

Male panel connectors attached by bolts

Circular male panel connector	533 235 006	533 275 006
Protective cap for panel connector	533 610 006	533 650 006

The electrical connection is made using a cable connector from our „Natto Miniature Push-Pull“ Series. Select the most appropriate type of cable connector to suit your operating conditions.

Natto Miniature Push-Pull – Female cable connector (page 48)

Female cable connector	530 232 006	530 272 006
Cable clamp	530 331 006	530 371 006
Protective cap for female cable connector	536 620 006	536 660 006

- Conductors attached by tin soldering. Select the type of soldering according to the operating temperature. Avoid thermal shocks during soldering.
- For assembly, wiring, panel connector installation and contact arrangement instructions, see: Technical guides.
- Other accessories, see: Accessories.

Numerical Index – Connectors with non-removable contacts

Part No.Series	Designation	Page
038 322 006 ..Standard	Square male panel connector	10
038 322 006 ..Weatherproof	Square male panel connector	22
038 322 006 ..Weatherproof PG	Square male panel connector	26
038 322 256 ..Weatherproof High-Performance PG	Square male panel connector	24
038 351 006 ..Standard	Square male panel connector	10
038 351 006 ..Weatherproof	Square male panel connector	22
038 351 006 ..Weatherproof PG	Square male panel connector	26
038 351 256 ..Weatherproof High-Performance PG	Square male panel connector	24
038 355 006 ..Standard	Square male panel connector	10
038 355 006 ..Weatherproof	Square male panel connector	22
038 355 006 ..Weatherproof PG	Square male panel connector	26
038 355 256 ..Weatherproof High-Performance PG	Square male panel connector	24
038 356 006 ..Standard	Square male panel connector	10
038 356 006 ..Weatherproof	Square male panel connector	22
038 356 006 ..Weatherproof PG	Square male panel connector	26
038 356 256 ..Weatherproof High-Performance PG	Square male panel connector	24
038 359 006 ..Standard	Square male panel connector	10
038 359 006 ..Weatherproof	Square male panel connector	22
038 359 006 ..Weatherproof PG	Square male panel connector	26
038 359 256 ..Weatherproof High-Performance PG	Square male panel connector	24
038 382 006 ..Standard	Female cable connector	10
042 953 006 ..Standard	Female cable connector	10
042 954 006 ..Standard	Female cable connector	10
042 955 006 ..Standard	Female cable connector	10
042 956 006 ..Standard	Female cable connector	10
042 977 006 ..Standard	Female cable connector	10
042 986 006 ..Standard	Square male panel connector	10
042 986 006 ..Weatherproof	Square male panel connector	22
042 986 256 ..Weatherproof High-Performance PG	Square male panel connector	24
042 990 006 ..Standard	Female cable connector	10
043 001 006 ..Standard	Square male panel connector	10
043 001 006 ..Weatherproof	Square male panel connector	22
043 001 256 ..Weatherproof High-Performance PG	Square male panel connector	24
043 082 006 ..Standard	Square male panel connector	10
043 082 006 ..Weatherproof	Square male panel connector	22
043 082 006 ..Weatherproof PG	Square male panel connector	26
043 082 256 ..Weatherproof High-Performance PG	Square male panel connector	24
043 085 006 ..Standard	Female cable connector	10
216 003 006 ..Hermetic Pneurop	Circular male panel connector	34
216 004 006 ..Hermetic Pneurop	Circular male panel connector	34
216 006 006 ..Hermetic Pneurop	Circular male panel connector	34
225 008 006 ..Hermetic Pneurop	Circular male panel connector	34
225 014 006 ..Hermetic Pneurop	Circular male panel connector	34
225 063 006 ..Hermetic Ultra-Vide	Circular male panel connector	36
240 012 006 ..Hermetic Pneurop	Circular male panel connector	34
240 017 006 ..Hermetic Pneurop	Circular male panel connector	34
250 025 006 ..Hermetic Pneurop	Circular male panel connector	34
250 035 006 ..Hermetic Pneurop	Circular male panel connector	34
250 052 006 ..Hermetic Pneurop	Circular male panel connector	34
340 003 006 ..Hermetic Ultra-Vide	Circular male panel connector	36
340 004 006 ..Hermetic Ultra-Vide	Circular male panel connector	36
340 006 006 ..Hermetic Ultra-Vide	Circular male panel connector	36
340 008 006 ..Hermetic Ultra-Vide	Circular male panel connector	36
340 012 006 ..Hermetic Ultra-Vide	Circular male panel connector	36
340 014 006 ..Hermetic Ultra-Vide	Circular male panel connector	36
340 017 006 ..Hermetic Ultra-Vide	Circular male panel connector	36
363 035 006 ..Hermetic Ultra-Vide	Circular male panel connector	36
363 052 006 ..Hermetic Ultra-Vide	Circular male panel connector	36
530 103 006 ..Rapid with gold-plated contacts	Male coupler connectors	18
530 104 006 ..Rapid with gold-plated contacts	Male coupler connectors	18
530 106 006 ..Rapid with gold-plated contacts	Male coupler connectors	18
530 107 006 ..Rapid with gold-plated contacts	Male coupler connectors	18
530 108 006 ..Rapid with gold-plated contacts	Male coupler connectors	18
530 112 006 ..Rapid with gold-plated contacts	Male coupler connectors	18
530 117 006 ..Rapid	Male coupler connectors	16
530 153 006 ..Standard	Female coupler connectors	10
530 153 006 ..Rapid	Female coupler connectors	16
530 154 006 ..Standard	Female coupler connectors	10

Part No.Series	Designation	Page
530 154 006 ..Rapid	Female coupler connectors	16
530 156 006 ..Standard	Female coupler connectors	10
530 156 006 ..Rapid	Female coupler connectors	16
530 158 006 ..Standard	Female coupler connectors	10
530 158 006 ..Rapid	Female coupler connectors	16
530 162 006 ..Standard	Female coupler connectors	10
530 162 006 ..Rapid	Female coupler connectors	16
530 167 006 ..Rapid	Female coupler connectors	16
530 170 006 ..Standard	Female coupler connectors	10
530 175 006 ..Standard	Female coupler connectors	10
530 183 006 ..Rapid with gold-plated contacts	Female coupler connectors	18
530 184 006 ..Standard with gold-plated contacts	Female coupler connectors	18
530 186 006 ..Rapid with gold-plated contacts	Female coupler connectors	18
530 187 006 ..Rapid with gold-plated contacts	Female coupler connectors	18
530 188 006 ..Rapid with gold-plated contacts	Female coupler connectors	18
530 192 006 ..Rapid with gold-plated contacts	Female coupler connectors	18
530 700 006 ..Standard	Male cable connector	10
530 703 006 ..Standard	Female cable connector	10
530 707 006 ..Standard	Male coupler connectors	10
530 710 006 ..Weatherproof	Male cable connector + cable clamp, small outlet	22
530 711 006 ..Weatherproof	Male cable connector + cable clamp, large outlet	22
530 713 006 ..Weatherproof	Female cable connector + cable clamp, small outlet	22
530 714 006 ..Weatherproof	Female cable connector + cable clamp, large outlet	22
530 717 006 ..Weatherproof	Male coupler connectors + cable clamp, small outlet	22
530 718 006 ..Weatherproof	Male coupler connectors + cable clamp, large outlet	22
530 752 006 ..Rapid	Male coupler connectors	16
530 752 006 ..Rapid with gold-plated contacts	Male coupler connectors	18
530 753 006 ..Standard	Female coupler connectors	10
530 753 006 ..Rapid	Female coupler connectors	16
530 753 006 ..Rapid with gold-plated contacts	Female coupler connectors	18
530 754 006 ..Rapid	Male cable connector	16
530 754 006 ..Rapid with gold-plated contacts	Male cable connector	18
530 755 006 ..Rapid	Female cable connector	16
530 755 006 ..Rapid with gold-plated contacts	Female cable connector	18
530 760 006 ..Standard	Male cable connector	10
530 763 006 ..Standard	Female cable connector	10
530 768 006 ..Standard	Male coupler connectors	10
530 770 006 ..Weatherproof	Male cable connector + cable clamp, large outlet	22
530 773 006 ..Weatherproof	Female cable connector + cable clamp, large outlet	22
530 776 006 ..Weatherproof	Male coupler connectors + cable clamp, large outlet	22
532 003 006 ..Rapid	Female cable connector	16
532 004 006 ..Rapid	Female cable connector	16
532 006 006 ..Rapid	Female cable connector	16
532 008 006 ..Rapid	Female cable connector	16
532 012 006 ..Rapid	Female cable connector	16
532 103 006 ..Rapid	Male coupler connectors	16
532 104 006 ..Rapid	Male coupler connectors	16
532 106 006 ..Rapid	Male coupler connectors	16
532 108 006 ..Rapid	Male coupler connectors	16
532 112 006 ..Rapid	Male coupler connectors	16
532 121 006 ..Standard Thermocouple	Male coupler connectors	14
532 122 006 ..Standard Thermocouple	Male coupler connectors	14
532 123 006 ..Standard Thermocouple	Male coupler connectors	14
532 161 006 ..Standard Thermocouple	Female cable connector	14
532 162 006 ..Standard Thermocouple	Female cable connector	14
532 163 006 ..Standard Thermocouple	Female cable connector	14
532 203 006 ..Standard	Male coupler connectors	10
532 204 006 ..Standard	Male coupler connectors	10
532 206 006 ..Standard	Male coupler connectors	10
532 208 006 ..Standard	Male coupler connectors	10
532 212 006 ..Standard	Male coupler connectors	10
532 217 006 ..Standard	Male coupler connectors	10
532 225 006 ..Standard	Male coupler connectors	10
532 235 006 ..Standard	Male coupler connectors	10
532 353 006 ..Rapid with gold-plated contacts	Female cable connector	18
532 354 006 ..Rapid with gold-plated contacts	Female cable connector	18
532 356 006 ..Rapid with gold-plated contacts	Female cable connector	18
532 357 006 ..Rapid with gold-plated contacts	Female cable connector	18

Connectors with removable contacts

**Miniature Push-Pull Series / Miniature Series / Industrial Series / Marine Series /
Neptunox Series / Robotic Series / Minex Series / Printed Circuits Series /
Power Series Puissance**



Miniature Push-Pull Series



Atto Miniature Push-Pull
Natto Miniature Push-Pull
Natto Miniature Push-Pull High-Performance

Our Push-Pull Series is intended for applications which are both compact and high-performance. It is also available in a high-performance version for more stringent requirements.

- Multi-pole with 3 to 27 solder / crimp contacts
- Push-Pull locking
- IP 65
- Circular housing

Miniature Series



Miniature
Weatherproof Miniature
Miniature with ground contact
Weatherproof Miniature with ground contact
Miniature with bulkhead connector

Our Miniature Series has a range with a high contact density. It is available in a weatherproof version and a version with earth contact for safer use.

- Multi-pole with 12 to 55 solder / crimp contacts
- 1/6 turn click locking
- IP 50 – 65
- Rectangular / circular housing

Industrial Series



Industrial
Industrial Weatherproof
Industrial High-Performance
Industrial with 17 mixed contacts
Industrial with bulkhead connector

Our Industrial Series has a wide, robust range. It is available in a weatherproof version, a high-performance version for use in harsh environments and a version with ground contact for safer use.

- Multi-pole with 3 to 27 solder / crimp contacts
- 1/6 turn click locking
- IP 50 – 65
- Rectangular / circular housing

Marine Series



Marine

Our Marine Series is suitable for harsh environments, under-sea connections or other immersion, excellent corrosion resistance.

- Multi-pole with 3 to 37 solder / crimp contacts
- Screw connection
- IP 68
- Weatherproof to: 10 bars
- Material: ARCAP

Neptunox Series



Neptunox

Our Neptunox Series is derived from our Marine Series. It has similar characteristics for a lesser cost.

- Multi-pole with 3 to 37 solder / crimp contacts
- Screw connection
- IP 68
- Weatherproof to: 10 bars
- Material: 303 stainless steel

Robotic Series



Robotic
Robotic with 17 mixed contacts

Our Robotic Series is particularly robust. It is designed to withstand impacts and vibrations and the rear outlets of its housing can take large diameter cables. It is available in a version with 17 mixed contacts to allow power cables and signal cables to be installed in the same connector.

- Multi-pole with 3 to 37 solder / crimp contacts
- Screw connection
- IP 50 – 65
- Rectangular housing

Minex Series



Minex

Our Minex Series is very light, compact and performs well. It is non-oxidising.

- Multi-pole with 3 to 7 solder / crimp contacts
- Screw connection
- IP 65
- Plastic material: POM / PBT

Printed Circuits Series



- Atto Miniature Push-Pull
- Natto Miniature Push-Pull
- Miniature
- Industrial
- Minex

Our Printed Circuits Series is available in a very wide range with very varied performances, thus satisfying many applications.

- Multi-pole with 3 to 55 solder contacts
- Contacts for Printed Circuits
- Screw connection / Push-Pull / 1/6 of a turn click locking
- IP 50 – 65

Power Series Puissance



- 95 mm² circular single-pole 300 A
- 35 mm² rectangular single-pole 175 A
- 35 mm² circular multi-pole 175 A
- 25 mm² circular multi-pole 175 A
- 25 mm² rectangular multi-pole 175 A
- 25 mm² circular multi-pole 175 A

Our Power Series Puissance is designed to constantly carry a very high current.

- Multi-pole 1 to 4 solder / crimp contacts
- Screw connection
- IP 50 – 65
- Current: 175 to 300 A
- Conductor cross-section: 16 to 95 mm²

* Our connectors are suitable for an almost unlimited number of applications, because of our wide range for all types of installation.

Technical Data

RoHS

Panel connector



Cable connector



Coupler connector



Panel connector, cable connector and coupler connector

circular housing

Locking	Push-Pull, for frequent mating
Protection	IP 65 with flat-gasket for panel connector
Contacts	7 to 27 contacts \varnothing 0,76 mm, crimp or solder removable contacts
Max. current	5 A \varnothing 0,76 mm
Mechanical endurance	50000 locking and mating cycles
Contact resistance	< 3 m Ω
Breakdown voltage between adjacent contacts	> 1500 Volts (RMS)
Insulation resistance	> 5000 M Ω
Operating temperature	-40 °C to +100 °C (500 hours at +100 °C)
Materials	Nickel-plated light alloy, gold-plated brass contacts, neoprene insert
Max. conductor cross-section	0,34 mm ²

Dimensional Data

Square panel connector

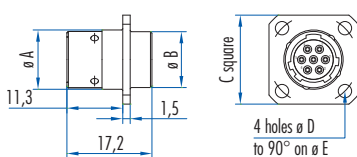

Circular panel connector

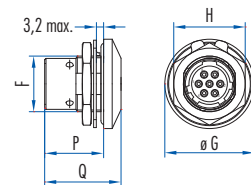

Cable connector

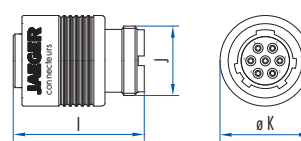

Coupler connector

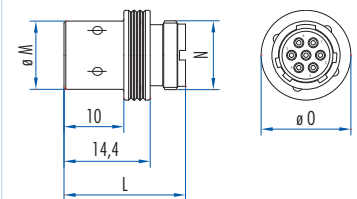

Housing	Number of Contacts	Square panel connector					Circular panel connector					Cable connector			Coupler connector			
		\varnothing A	\varnothing B	C	\varnothing D	\varnothing E	F	\varnothing G	H	P	Q	I	J	\varnothing K	L	\varnothing M	N	\varnothing O
00	7	12	11,3	18	2,7	18	M12,5	20	16	13,3	17,2	21,7	M11,5	15	20,3	11,4	M1,5	15
0	8-12-19	14,9	14,9	20	2,7	21	M16	23	19	13,3	17,2	22,2	M15	18,7	20,8	14,9	M15	18,7
1	27	21	20,9	27	3,2	28	M25	34	30	17,9	20,3	24,2	M20	25	24,2	20,1	M20	24

Part Number

Housing	00	0	0	0	1
Number of Contacts ø 0,76 mm	7	8	12	19	27

Male panel connectors – Female cable connectors – Male coupler connectors

Square male panel connector	761 107 006	761 108 006	761 112 006	761 119 006	761 127 006
Circular male panel connector	761 107 206	761 108 206	761 112 206	761 119 206	761 127 206
Female cable connector	762 207 006	762 208 006	762 212 006	762 219 006	762 227 006
Male coupler connector	763 107 006	763 108 006	763 112 006	763 119 006	763 127 006
Long cable gland	769 807 006	769 819 006	769 819 006	769 819 006	769 827 006
Flat-Gasket for panel connector (pack of 10)	533 328 006	533 368 006	533 368 006	533 368 006	536 945 006
Cable clamps	769 607 006	769 619 006	769 619 006	769 619 006	769 627 006
Protective cap for panel connector	533 610 006	533 650 006	533 650 006	533 650 006	761 907 006
Protective cap for cable connector	536 620 006	536 660 006	536 660 006	536 660 006	536 610 006

Crimp tool without positioner 630 180 006, positioner 769 100 006

Tool for insertion and removing contacts 769 131 006

Female panel connectors – Male cable connectors – Female coupler connectors

Square female panel connector	761 207 006	761 208 006	761 212 006	761 219 006	761 227 006
Circular female panel connector	761 207 206	761 208 206	761 212 206	761 219 206	761 227 206
Male cable connector	762 107 006	762 108 006	762 112 006	762 119 006	762 127 006
Female coupler connector	763 207 006	763 208 006	763 212 006	763 219 006	763 227 006
Long cable gland	769 807 006	769 819 006	769 819 006	769 819 006	769 827 006
Flat-Gasket for panel connector (pack of 10)	533 328 006	533 368 006	533 368 006	533 368 006	536 945 006
Cable clamps	769 607 006	769 619 006	769 619 006	769 619 006	769 627 006
Protective cap for panel connector	533 610 006	533 650 006	533 650 006	533 650 006	761 907 006
Protective cap for cable connector	536 620 006	536 660 006	536 660 006	536 660 006	536 610 006

Crimp tool without positioner 630 180 006, positioner 769 100 006

Tool for insertion and removing contacts 769 131 006

- Straight and right-angle panel connectors are also available for printed circuit boards.
- **Important:** All the contacts must be mounted in the insert using our tool.
- For assembly, wiring, panel connector installation and contact arrangement instructions, see: Technical guides;
- Other accessories, see: Accessories.
- All connectors are delivered with their contacts.

Miniature Push-Pull Series – Natto Miniature Push-Pull

Technical Data

RoHS

Panel connector



Cable connector



Coupler connector



Panel connector, cable connector and coupler connector

circular housing

Locking	Push-Pull, for frequent mating
Protection	IP 65 with flat-gasket for panel connector except for housing 1 IP 50 to 54 with conexil in the housing and flat-gasket for panel connector
Contacts	3 to 19 contacts \varnothing 1 mm, \varnothing 1,6 mm and \varnothing 2,4 mm, crimp or solder removable contacts
Max. current	7 A \varnothing 1 mm, 15 A \varnothing 1,6 mm et 30 A \varnothing 2,4 mm
Mechanical endurance	50000 locking and mating cycles
Contact resistance	$< 2 \text{ m}\Omega$ 1 mm – $< 1,5 \text{ m}\Omega$ 1,6 mm – $< 1 \text{ m}\Omega$ 2,4 mm
Breakdown voltage between adjacent contacts	> 2500 Volts (RMS)
Insulation resistance	$> 5000 \text{ M}\Omega$
Operating temperature	-40°C to $+100^\circ\text{C}$ (500 hours at $+100^\circ\text{C}$)
Materials	Nickel-plated light alloy, gold-plated brass contacts, neoprene insert

Max. conductor cross-section

Contact	\varnothing	\varnothing	\varnothing
	1 mm	1,6 mm	2,4 mm
Soldered	0,6 mm ²	1,5 mm ²	3,18 mm ²
Crimped *	0,6 to 0,93 mm ²	0,6 to 1,5 mm ²	1,34 to 3,18 mm ²

* According to the Number of Contacts

Dimensional Data

Square panel connector

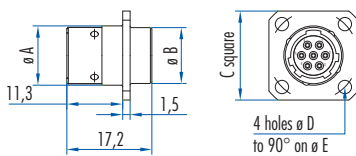

Circular panel connector

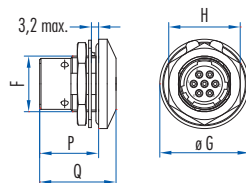

Cable connector

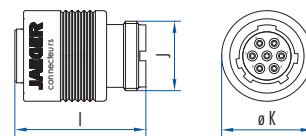

Coupler connector

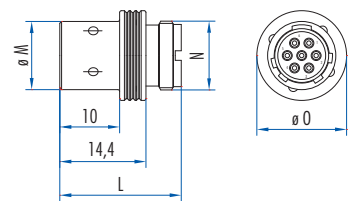

Housing	\varnothing mm	Number of Contacts	Square panel connector					Circular panel connector					Cable connector			Coupler connector			
			\varnothing A	\varnothing B	C	\varnothing D	\varnothing E	F	\varnothing G	H	P	Q	I	J	\varnothing K	L	\varnothing M	N	\varnothing O
00	1	3-4	12	11,3	18	2,7	18	M12,5	20	16	13,3	17,2	21,7	M11,5	15	20,3	11,4	M11,5	15
0	1	7	14,9	14,9	20	2,7	21	M16	23	19	13,3	17,2	22,2	M15	18,7	20,8	14,9	M15	18,7
1	1	12-19	21	20,9	27	3,2	28	M25	34	30	17,9	20,3	24,2	M20	25	24,2	20,1	M20	24
1	1,6	3-4-7	21	20,9	27	3,2	28	M25	34	30	17,9	20,3	24,2	M20	25	24,2	20,1	M20	24
1	2,4	3-4	21	20,9	27	3,2	28	M25	34	30	17,9	20,3	24,2	M20	25	24,2	20,1	M20	24

Part Number

Housing	00	00	0	1	1	1	1	1	1	1
Number of Contacts	3	4	7	12	19	3	4	7	3	4
L ø mm	1	1	1	1	1	1,6	1,6	1,6	2,4	2,4

Male panel connectors – Female cable connectors – Male coupler connectors

Square male panel connector	533 233 006	533 801 006	533 273 006	533 283 006	533 293 006	535 310 006	535 350 006	535 390 006	535 430 006	535 470 006
Circular male panel connector	533 239 006	533 811 006	533 279 006	533 319 006	533 359 006	535 310 206	535 350 206	535 390 206	535 430 206	535 470 206
Female cable connector	530 232 006	530 801 006	530 272 006	530 282 006	530 292 006	535 111 006	535 151 006	535 191 006	535 231 006	535 271 006
Male coupler connector	530 239 006	530 811 006	530 279 006	530 812 006	530 815 006	535 210 006	535 250 006	535 290 006	535 330 006	535 370 006
Union nut	530 330 006	530 840 006	530 370 006							
Flat-Gasket for panel connector (pack of 10)	533 328 006	533 328 006	533 368 006	536 945 006	536 945 006	536 945 006	536 945 006	536 945 006	536 945 006	536 945 006
Cable clamps	530 331 006	530 841 006	530 371 006	769 627 006	769 627 006	769 627 006	769 627 006	769 627 006	769 627 006	769 627 006
Protective cap for panel connector*	533 610 006	533 610 006	533 650 006	761 907 006	761 907 006	761 907 006	761 907 006	761 907 006	761 907 006	761 907 006

Complete crimp tool: 579 316 006 (small crimp: ø 1 mm), 579 481 006 (large crimp: ø 1 mm, ø 1,6 mm, ø 2,4 mm)

Tool for insertion and removing contacts ø 1 mm 597 104 006, ø 1,6 mm 577 454 006 ø 2,4 mm 577 458 006

Female panel connectors – Male cable connectors – Female coupler connectors

Square female panel connector	533 232 006	533 800 006	533 272 006	533 282 006	533 292 006	535 311 006	535 351 006	535 391 006	535 431 006	535 471 006
Circular female panel connector	533 238 006	533 810 006	533 278 006	533 318 006	533 358 006	535 311 206	535 351 206	535 391 206	535 431 206	535 471 206
Male cable connector	530 233 006	530 800 006	530 273 006	530 283 006	530 293 006	535 110 006	535 150 006	535 190 006	535 230 006	535 270 006
Female coupler connector	530 238 006	530 810 006	530 278 006	530 813 006	530 816 006	535 211 006	535 251 006	535 291 006	535 331 006	535 371 006
Union nut	530 330 006	530 840 006	530 370 006							
Flat-Gasket for panel connector (pack of 10)	533 328 006	533 328 006	533 368 006	536 945 006	536 945 006	536 945 006	536 945 006	536 945 006	536 945 006	536 945 006
Cable clamps	530 331 006	530 841 006	530 371 006	769 627 006	769 627 006	769 627 006	769 627 006	769 627 006	769 627 006	769 627 006
Protective cap for cable connector*	536 620 006	536 620 006	536 660 006	536 610 006	536 610 006	536 610 006	536 610 006	536 610 006	536 610 006	536 610 006

Complete crimp tool: 579 316 006 (small crimp: ø 1 mm), 579 481 006 (large crimp: ø 1 mm, ø 1,6 mm, ø 2,4 mm)

Tool for insertion and removing contacts ø 1 mm 597 104 006, ø 1,6 mm 577 454 006 ø 2,4 mm 577 458 006

* Male / Female

- Straight and right-angle panel connectors are also available for printed circuit boards.
- **Important:** All the contacts must be mounted in the insert using our tool.
- For assembly, wiring, panel connector installation and contact arrangement instructions, see: Technical guides;
- Other accessories, see: Accessories.
- Polarisation: Polarisation systems are available to prevent incorrect connection between identical connectors (same series and same contact arrangement). Consult us.
- All connectors are delivered with their contacts.
- Thermocouple contacts can be fitted. See: Accessories.
- ø 1,6 mm and ø 2,4mm, contact No. 1, which makes the electrical connection before the other contacts and disconnects it after their separation, can be used as a ground contact.

Technical Data

	Panel connector	Cable connector	Coupler connector																
Panel connector, cable connector and coupler connector																			
Locking	circular housing Push-Pull, for frequent mating																		
Protection	IP 65 with flat-gasket for panel connector except for housing 1 IP 50 to 54 with conexil in the housing and flat-gasket for panel connector																		
Contacts	3 to 19 contacts \varnothing 1 mm, \varnothing 1,6 mm and \varnothing 2,4 mm, crimp or solder removable contacts																		
Max. current	7 A \varnothing 1 mm, 15 A \varnothing 1,6 mm et 30 A \varnothing 2,4 mm																		
Mechanical endurance	50000 locking and mating cycles																		
Contact resistance	$< 2\text{ m}\Omega$ 1 mm – $< 1,5\text{ m}\Omega$ 1,6 mm – $< 1\text{ m}\Omega$ 2,4 mm																		
Breakdown voltage between adjacent contacts	> 2500 Volts eff																		
Insulation resistance	$> 5000\text{ M}\Omega$																		
Operating temperature	$-55\text{ }^\circ\text{C}$ to $+200\text{ }^\circ\text{C}$ (500 hours at $+200\text{ }^\circ\text{C}$)																		
Materials	Light alloy, black anodising, gold-plated brass contacts, silicon insert																		
Max. conductor cross-section	<table border="1"> <thead> <tr> <th>Contact</th> <th>\varnothing</th> <th>\varnothing</th> <th>\varnothing</th> </tr> </thead> <tbody> <tr> <td></td> <td>1 mm</td> <td>1,6 mm</td> <td>2,4 mm</td> </tr> <tr> <td>Soldered</td> <td>0,6 mm²</td> <td>1,5 mm²</td> <td>3,18 mm²</td> </tr> <tr> <td>Crimped *</td> <td>0,6 to 0,93 mm²</td> <td>0,6 to 1,5 mm²</td> <td>1,34 to 3,18 mm²</td> </tr> </tbody> </table>			Contact	\varnothing	\varnothing	\varnothing		1 mm	1,6 mm	2,4 mm	Soldered	0,6 mm ²	1,5 mm ²	3,18 mm ²	Crimped *	0,6 to 0,93 mm ²	0,6 to 1,5 mm ²	1,34 to 3,18 mm ²
Contact	\varnothing	\varnothing	\varnothing																
	1 mm	1,6 mm	2,4 mm																
Soldered	0,6 mm ²	1,5 mm ²	3,18 mm ²																
Crimped *	0,6 to 0,93 mm ²	0,6 to 1,5 mm ²	1,34 to 3,18 mm ²																
	* According to the Number of Contacts																		

Dimensional Data

Square panel connector

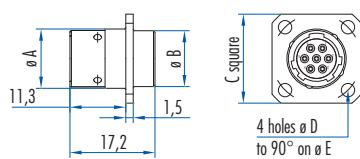

Circular panel connector

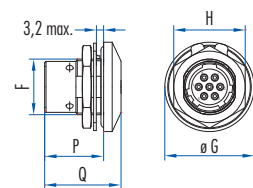

Cable connector

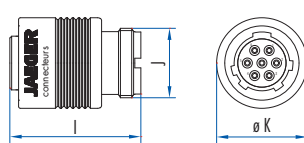

Coupler connector

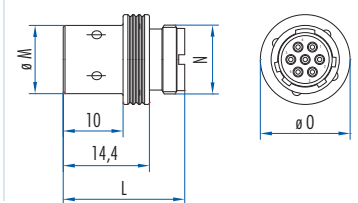

Housing	\varnothing mm	Number of Contacts	Square panel connector					Circular panel connector					Cable connector			Coupler connector			
			\varnothing A	\varnothing B	C	\varnothing D	\varnothing E	F	\varnothing G	H	P	Q	I	J	\varnothing K	L	\varnothing M	N	\varnothing O
00	1	3-4	12	11,3	18	2,7	18	M12,5	20	16	13,3	17,2	21,7	M11,5	15	20,3	11,4	M11,5	15
0	1	7	14,9	14,9	20	2,7	21	M16	23	19	13,3	17,2	22,2	M15	18,7	20,8	14,9	M15	18,7
1	1	12-19	21	20,9	27	3,2	28	M25	34	30	17,9	20,3	24,2	M20	25	24,2	20,1	M20	24
1	1,6	3-4-7	21	20,9	27	3,2	28	M25	34	30	17,9	20,3	24,2	M20	25	24,2	20,1	M20	24
1	2,4	3-4	21	20,9	27	3,2	28	M25	34	30	17,9	20,3	24,2	M20	25	24,2	20,1	M20	24

Miniature Push-Pull Series – Natto Miniature Push-Pull High-Performance

Part Number

Housing	00	00	0	1	1	1	1	1	1	1
Number of Contacts	3	4	7	12	19	3	4	7	3	4
L ø mm	1	1	1	1	1	1,6	1,6	1,6	2,4	2,4

Male panel connectors – Female cable connectors – Male coupler connectors

Square male panel connector	533 603 006	533 804 006	533 604 006			535 610 006	535 650 006	535 690 006		
Circular male panel connector	533 603 206	533 804 206	533 604 206			535 610 206	535 650 206	535 690 206		
Female cable connector	530 603 006	530 804 006	530 604 006			535 411 006	535 451 006	535 491 006		
Male coupler connector	530 633 006	530 824 006	530 634 006			535 510 006	535 550 006	535 590 006		
Flat-Gasket for panel connector (pack of 10)	533 328 016	533 328 016	533 368 016	536 945 016	536 945 016	536 945 016	536 945 016	536 945 016	536 945 016	536 945 016
Cable clamps	530 692 006	530 844 006	530 693 006							
Protective cap for panel connector*	533 610 106	533 610 106	533 650 106			761 907 106	761 907 106	761 907 106		

Complete crimp tool: 579 316 006 (small crimp: ø 1 mm), 579 481 006 (large crimp: ø 1 mm, ø 1,6 mm, ø 2,4 mm)

Tool for insertion and removing contacts ø 1 mm 597 104 006, ø 1,6 mm 577 454 006 ø 2,4 mm 577 458 006

Female panel connectors – Male cable connectors – Female coupler connectors

Square female panel connector	533 613 006	533 814 006	533 614 006			535 611 006	535 651 006	535 691 006		
Circular female panel connector	533 613 206	533 814 206	533 614 206			535 611 206	535 651 206	535 691 206		
Male cable connector	530 613 006	530 814 006	530 614 006			535 410 006	535 450 006	535 490 006		
Female coupler connector	530 623 006	530 834 006	530 624 006			535 511 006	535 551 006	535 591 006		
Flat-Gasket for panel connector (pack of 10)	533 328 016	533 328 016	533 368 016	536 945 016	536 945 016	536 945 016	536 945 016	536 945 016	536 945 016	536 945 016
Cable clamps	530 692 006	530 844 006	530 693 006							
Protective cap for cable connector*	536 620 106	536 620 106	536 660 106			536 610 106	536 610 106	536 610 106		

Complete crimp tool: 579 316 006 (small crimp: ø 1 mm), 579 481 006 (large crimp: ø 1 mm, ø 1,6 mm, ø 2,4 mm)

Tool for insertion and removing contacts ø 1 mm 597 104 006, ø 1,6 mm 577 454 006 ø 2,4 mm 577 458 006

* Male / Female

- **Important:** All the contacts must be mounted in the insert using our tool.
- For assembly, wiring, panel connector installation and contact arrangement instructions, see: Technical guides;
- Other accessories, see: Accessories.
- Polarisation: Polarisation systems are available to prevent incorrect connection between identical connectors (same series and same contact arrangement). Consult us.
- All connectors are delivered with their contacts.
- Thermocouple contacts can be fitted. See: Accessories.
- ø 1,6 mm and ø 2,4mm, contact No.1, which makes the electrical connection before the other contacts and disconnects it after their separation, can be used as a ground contact.

Technical Data

RoHS

Panel connector, cable connector and coupler connector

Panel connector



Cable connector



Coupler connector



Panel connector, cable connector and coupler connector	rectangular housing								
Locking	screw up the knurled ring on the cable connector 1/6 of a turn on the panel connector barrel, for frequent mating								
Protection	IP 50 to IP 54 with conexil in the housing, flat-gasket for panel connector								
Contacts	12 to 55 contacts \varnothing 1 mm, crimp or solder removable contacts								
Max. current	7 A \varnothing 1 mm								
Mechanical endurance	over 1000 locking and mating cycles, vibration: 10 g, 500 Hz (NF-C 20706[CEI68-2-6])								
Contact resistance between pin and socket	< 0,0020 Ω								
Breakdown voltage between adjacent contacts	at 20 °C, at sea-level: 19 or 37 contacts >2000 Volts (RMS), 12, 27 or 55 contacts >2500 Volts (RMS)								
Insulation resistance	> 5000 M Ω								
Operating temperature	-40 °C to +100 °C (500 hours at +125 °C)								
Materials	Nickel-plated light alloy, gold-plated brass contacts, neoprene insert								
Max. conductor cross-section	<table border="1"> <tr> <td>Contact</td> <td>\varnothing</td> </tr> <tr> <td></td> <td>1 mm</td> </tr> <tr> <td>Soldered</td> <td>0,6 mm²</td> </tr> <tr> <td>Crimped*</td> <td>0,6 to 0,93 mm²</td> </tr> </table> <p>* According to the Number of Contacts</p>	Contact	\varnothing		1 mm	Soldered	0,6 mm ²	Crimped*	0,6 to 0,93 mm ²
Contact	\varnothing								
	1 mm								
Soldered	0,6 mm ²								
Crimped*	0,6 to 0,93 mm ²								

Dimensional Data

Panel connector

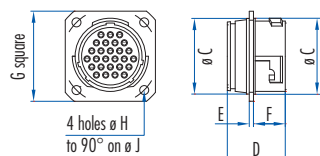

Cable connector

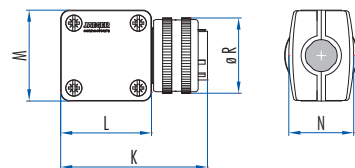

Coupler connector

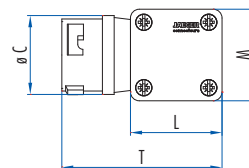

Cable connector – Panel connector assembly

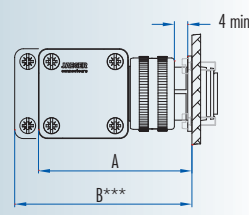

Housing	Number of Contacts	Assembly		Panel connector						Cable connector / Coupler connector						
		A	B	\varnothing C	D	E	F	G	\varnothing H	\varnothing J	K	L	M	N	\varnothing R	T
1	12-19	54	63	21	20,5	1,5	11,5	27	3,2	28	50	32,2	32,2	20,2	25	50,3
2	27-37	58	67	27	20,5	1,5	11,5	32	3,2	34	54	36,4	36,4	23,5	32,5	54,2
3	55	66	75	39	23	2	11,5	43	4,2	48	61	42,6	47,6	31,3	44	62,1

*** B: minimum disconnection distance

Part Number

Housing	1	1	2	2	3
Number of Contacts ø 1 mm	12	19	27	37	55

Male panel connectors – Female cable connectors – Male coupler connectors

Square male panel connector	#533 503 006	#533 514 006	#533 513 006	#533 525 006	#533 523 006
Female cable connector	530 502 006	530 504 006	530 512 006	530 520 006	530 522 006
Male coupler connector	530 507 006	530 514 006	530 517 006	530 525 006	530 527 006
Type 2 cable clamp	532 328 006	532 328 006	532 329 006	532 329 006	532 350 006
Housing for panel connector	533 550 006	533 550 006	533 558 006	533 558 006	533 559 006
Protective cap for panel connector	630 720 006	630 720 006	536 845 006	536 845 006	536 846 006
Protective cap for cable connector	632 720 006	632 720 006	532 214 006	532 214 006	532 218 006
Protective cap for coupler connector	533 620 006	533 620 006	533 660 006	533 660 006	
Flat-Gasket for panel connector (pack of 10)	536 945 006	536 945 006	536 946 006	536 946 006	536 947 006

Complete crimp tool: 579 316 006 (small tool: ø 1 mm), 579 481 006 (large tool: ø 1 mm, ø 1,6 mm, ø 2,4 mm)

Tool for insertion and removing contacts 597 104 006

Female panel connectors – Male cable connectors – Female coupler connectors

Square female panel connector	#533 502 006	#533 515 006	#533 512 006	#533 524 006	#533 522 006
Male cable connector	530 503 006	530 505 006	530 513 006	530 521 006	530 523 006
Female coupler connector	530 506 006	530 515 006	530 516 006	530 524 006	530 526 006
Type 2 cable clamp	532 328 006	532 328 006	532 329 006	532 329 006	532 350 006
Housing for panel connector	533 550 006	533 550 006	533 558 006	533 558 006	533 559 006
Protective cap for panel connector	630 720 006	630 720 006	536 845 006	536 845 006	536 846 006
Protective cap for cable connector	632 720 006	632 720 006	532 214 006	532 214 006	532 218 006
Protective cap for coupler connector	533 620 006	533 620 006	533 660 006	533 660 006	
Flat-Gasket for panel connector (pack of 10)	536 945 006	536 945 006	536 946 006	536 946 006	536 947 006

Complete crimp tool: 579 316 006 (small crimp: ø 1 mm), 579 481 006 (large crimp: ø 1 mm, ø 1,6 mm, ø 2,4 mm)

Tool for insertion and removing contacts 597 104 006

- # Square panel connectors are generally of the „Weatherproof Miniature“ type. See page 54.
- Sealable tamper-evident connectors for housings 1 and 2. See: Accessories.
- **Important:** All the contacts must be mounted in the insert using our tool.
- For assembly, wiring, panel connector installation and contact arrangement instructions, see: Technical guides;
- Other accessories, see: Accessories.
- Polarisation: Polarisation systems are available to prevent incorrect connection between identical connectors (same series and same contact arrangement). See: Technical guides;
- All connectors are delivered with their contacts.
- Thermocouple contacts can be fitted. See: Accessories.

Technical Data

RoHS

Panel connector, cable connector and coupler connector

Panel connector



Cable connector



Coupler connector



Panel connector, cable connector and coupler connector	circular housing								
Locking	screw up the knurled ring on the cable connector 1/6 of a turn on the panel connector barrel, for frequent locking and unlocking								
Protection	IP 65 with flat-gasket for panel connector								
Contacts	12 to 55 contacts \varnothing 1 mm, crimp or solder removable contacts								
Max. current	7A \varnothing 1 mm								
Mechanical performance	< 1000 locking and mating cycles, vibration: 10 g, 500Hz (NF-C 20706[CEI68-2-6])								
Contact resistance between pin and socket	< 0,0020 Ω								
Breakdown voltage between adjacent contacts	at 20 °C, at sea-level: 19 or 37 contacts >2000 Volts (RMS), 12, 27 or 55 contacts >2500 Volts (RMS)								
Insulation resistance	> 5000 M Ω								
Operating temperature	-40 °C to +100 °C (500 hours at +125 °C)								
Materials	Nickel-plated light alloy, gold-plated brass contacts, neoprene insert								
Max. conductor cross-section	<table border="1"> <tr> <td>Contact</td> <td>\varnothing</td> </tr> <tr> <td></td> <td>1 mm</td> </tr> <tr> <td>Soldered</td> <td>0,6 mm²</td> </tr> <tr> <td>Crimped*</td> <td>0,6 to 0,93 mm²</td> </tr> </table> <p>* According to the Number of Contacts</p>	Contact	\varnothing		1 mm	Soldered	0,6 mm ²	Crimped*	0,6 to 0,93 mm ²
Contact	\varnothing								
	1 mm								
Soldered	0,6 mm ²								
Crimped*	0,6 to 0,93 mm ²								

Dimensional Data

Panel connector

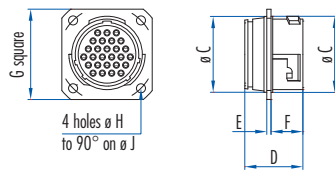

Cable connector

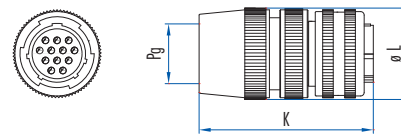

Coupler connector

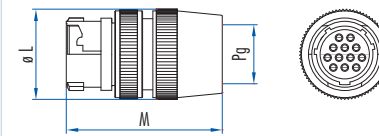

Housing	Number of Contacts	Assembly		Panel connector						Cable connector and Coupler connector				
		A	B	\varnothing C	D	E	F	G	\varnothing H	\varnothing J	K	\varnothing L	PG	M
1	12-19	53,5	70	21	20,5	1,5	11,5	27	3,2	28	42	26	11	52
2	27-37	63,5	82,5	27	20,5	1,5	11,5	32	3,2	34	59,5	34	16	55
3	55	72,5	100	39	23	2	11,5	43	4,2	48	68,5	44	21	59

Cable connector – Panel connector assembly

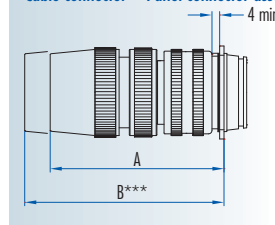

*** B: minimum disconnection distance

Part Number

Housing	1	1	2	2	3
Number of Contacts \varnothing 1 mm	12	19	27	37	55

Male panel connectors – Female cable connectors – Male coupler connectors

Square male panel connector	#533 503 006	#533 514 006	#533 513 006	#533 525 006	#533 523 006
Female cable connector	637 612 006	637 619 006	637 627 006	637 637 006	637 655 006
Male coupler connector	637 762 006	637 769 006	637 777 006	637 787 006	637 795 006
PG	PG 11	PG 11	PG 16	PG 16	PG 21
Cable clamps	633 421 006	633 421 006	633 422 006	633 422 006	633 423 006
L Capacity of the cable clamp in mm	\varnothing 7 – 12	\varnothing 7 – 12	\varnothing 9 – 17	\varnothing 9 – 17	\varnothing 12,5 – 23
Protective cap for panel connector	630 720 006	630 720 006	536 845 006	536 845 006	536 846 006
Protective cap for cable connector	632 725 006	632 725 006	632 726 006	632 726 006	632 728 006
Protective cap for coupler connector	632 771 006	632 771 006	632 772 006	632 772 006	632 773 006
Flat-Gasket for panel connector (pack of 10)	536 945 006	536 945 006	536 946 006	536 946 006	536 947 006

Complete crimp tool: 579 316 006 (small crimp: \varnothing 1 mm), 579 481 006 (large crimp: \varnothing 1 mm, \varnothing 1,6 mm, \varnothing 2,4 mm)

Tool for insertion and removing contacts 597 104 006

Female panel connectors – Male cable connectors – Female coupler connectors

Square female panel connector	#533 502 006	#533 515 006	#533 512 006	#533 524 006	#533 522 006
Male cable connector	637 712 006	637 719 006	637 727 006	637 737 006	637 755 006
Female coupler connector	637 662 006	637 669 006	637 677 006	637 687 006	637 695 006
PG	PG 11	PG 11	PG 16	PG 16	PG 21
Cable clamps	633 421 006	633 421 006	633 422 006	633 422 006	633 423 006
L Capacity of the cable clamp in mm	\varnothing 7 – 12	\varnothing 7 – 12	\varnothing 9 – 17	\varnothing 9 – 17	\varnothing 12,5 – 23
Protective cap for panel connector	630 720 006	630 720 006	536 845 006	536 845 006	536 846 006
Protective cap for cable connector	632 725 006	632 725 006	632 726 006	632 726 006	632 728 006
Protective cap for coupler connector	632 771 006	632 771 006	632 772 006	632 772 006	632 773 006
Flat-Gasket for panel connector (pack of 10)	536 945 006	536 945 006	536 946 006	536 946 006	536 947 006

Complete crimp tool: 579 316 006 (small crimp: \varnothing 1 mm), 579 481 006 (large crimp: \varnothing 1 mm, \varnothing 1,6 mm, \varnothing 2,4 mm)

Tool for insertion and removing contacts 597 104 006

- Moulded watertight rubber boots for cables are delivered with the connectors. They must be mounted in the cable connectors or coupler connector.
- Boots for wire-to-wire cables and assemblies are available on request.
- # Square panel connectors are also of the „Miniature“ type. See page 52.
- Other sizes of PG available. Consult us.
- **Important:** All the contacts must be mounted in the insert using our tool.
- For assembly, wiring, panel connector installation and contact arrangement instructions, see: Technical guides;
- Other accessories, see: Accessories.
- Polarisation: Polarisation systems are available to prevent incorrect connection between identical connectors (same series and same contact arrangement). See: Technical guides;
- All connectors are delivered with their contacts.
- Thermocouple contacts can be fitted. See: Accessories.

Technical Data

RoHS

Panel connector, cable connector and coupler connector

Panel connector



Cable connector



Coupler connector



Locking	rectangular housing screw up the knurled ring on the cable connector 1/6 of a turn on the panel connector barrel, for frequent locking and unlocking
Protection	IP 50 to IP 54 with conexil in the housing, flat-gasket for panel connector
Contacts	12 to 55 contacts \varnothing 1 mm, crimp or solder removable contacts
Max. current	7 A \varnothing 1 mm
Mechanical performance	1000 locking and mating cycles
Contact resistance between pin and socket	< 0,0020 Ω
Breakdown voltage between adjacent contacts	at 20 °C, at sea-level: 19 or 37 contacts >2000 Volts (RMS), 12, 27 or 55 contacts >2500 Volts (RMS)
Insulation resistance	> 5000 M Ω
Operating temperature	-40 °C to +100 °C (500 hours at +125 °C)
Materials	Nickel-plated light alloy, gold-plated brass contacts, neoprene insert

Max. conductor cross-section

Contact	\varnothing 1 mm
Soldered	0,6 mm ²
Crimped*	0,6 to 0,93 mm ²

* According to the Number of Contacts

Dimensional Data

Panel connector

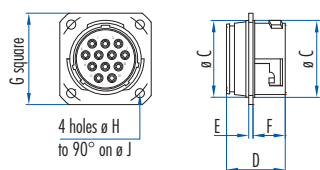

Cable connector

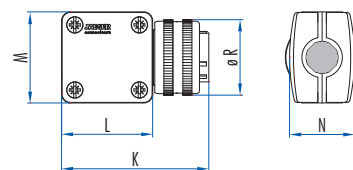

Coupler connector

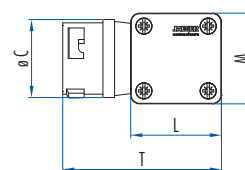

Cable connector – Panel connector assembly

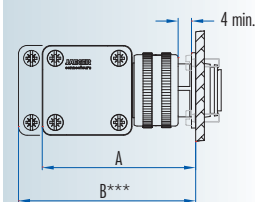

Housing	Number of Contacts	Assembly		Panel connector						Cable connector and Coupler connector						
		A	B	\varnothing C	D	E	F	G	\varnothing H	\varnothing J	K	M	N	L	\varnothing R	T
1	12-19	54	63	21	20,5	1,5	11,5	27	3,2	28	50	32,2	32,2	20,2	25	50,3
2	27-37	58	67	27	20,5	1,5	11,5	32	3,2	34	54	36,4	36,4	23,5	32,5	54,2
3	55	66	75	39	23	2	11,5	43	4,2	48	61	42,6	47,6	31,3	44	62,1

*** B: minimum disconnection distance

Part Number

Housing	1	1	2	2	3
Number of Contacts ø 1 mm	12	19	27	37	55

Male panel connectors – Female cable connectors – Male coupler connectors

Square male panel connector	◇533 503 506	◇533 514 506	◇533 513 506	◇533 525 506	◇533 523 506
Female cable connector	530 502 506	530 504 506	530 512 506	530 520 506	530 522 506
Male coupler connector	530 507 506	530 514 506	530 517 506	530 525 506	530 527 506
Type 2 cable clamp	532 328 006	532 328 006	532 329 006	532 329 006	532 350 006
Housing for panel connector	533 550 006	533 550 006	533 558 006	533 558 006	533 559 006
Protective cap for panel connector	630 720 006	630 720 006	536 845 006	536 845 006	536 846 006
Protective cap for cable connector	632 720 006	632 720 006	532 214 006	532 214 006	532 218 006
Protective cap for coupler connector	533 620 006	533 620 006	533 660 006	533 660 006	
Flat-Gasket for panel connector (pack of 10)	536 945 006	536 945 006	536 946 006	536 946 006	536 947 006

Complete crimp tool: 579 316 006 (small crimp: ø 1 mm), 579 481 006 (large crimp: ø 1 mm, ø 1,6 mm, ø 2,4 mm)

Tool for insertion and removing contacts 597 104 006

Female panel connectors – Male cable connectors – Female coupler connectors

Square female panel connector	◇533 502 506	◇533 515 506	◇533 512 506	◇533 524 506	◇533 522 506
Male cable connector	530 503 506	530 505 506	530 513 506	530 521 506	530 523 506
Female coupler connector	530 506 506	530 515 506	530 516 506	530 524 506	530 526 506
Type 2 cable clamp	532 328 006	532 328 006	532 329 006	532 329 006	532 350 006
Housing for panel connector	533 550 006	533 550 006	533 558 006	533 558 006	533 559 006
Protective cap for panel connector	630 720 006	630 720 006	536 845 006	536 845 006	536 846 006
Protective cap for cable connector	632 720 006	632 720 006	532 214 006	532 214 006	532 218 006
Protective cap for coupler connector	533 620 006	533 620 006	533 660 006	533 660 006	
Flat-Gasket for panel connector (pack of 10)	536 945 006	536 945 006	536 946 006	536 946 006	536 947 006

Complete crimp tool: 579 316 006 (small crimp: ø 1 mm), 579 481 006 (large crimp: ø 1 mm, ø 1,6 mm, ø 2,4 mm)

Tool for insertion and removing contacts 597 104 006

- ◇ Square panel connectors are generally of the „Weatherproof Miniature“ type. See page 58.
- Sealable tamper-evident connectors for housings 1 and 2. See: Accessories.
- **Important:** All the contacts must be mounted in the insert using our tool.
- For assembly, wiring, panel connector installation and contact arrangement instructions, see: Technical guides;
- Other accessories, see: Accessories.
- Polarisation: Polarisation systems are available to prevent incorrect connection between identical connectors (same series and same contact arrangement). See: Technical guides;
- All connectors are delivered with their contacts.

Technical Data

RoHS

Panel connector, cable connector and coupler connector

Panel connector



Cable connector



Coupler connector



Panel connector, cable connector and coupler connector	circular housing								
Locking	screw up the knurled ring on the cable connector 1/6 of a turn on the panel connector barrel, for frequent locking and unlocking								
Protection	IP 65 with flat-gasket for panel connector								
Contacts	12 to 55 contacts \varnothing 1 mm, crimp or solder removable contacts								
Max. current	7 A \varnothing 1 mm								
Mechanical performance	1000 locking and mating cycles								
Contact resistance between pin and socket	< 0,0020 Ω								
Breakdown voltage between adjacent contacts	at 20 °C, at sea-level: 19 or 37 contacts >2000 Volts (RMS), 12, 27 or 55 contacts >2500 Volts (RMS)								
Insulation resistance	> 5000 M Ω								
Operating temperature	-40 °C to +100 °C (500 hours at +125 °C)								
Materials	Nickel-plated light alloy, gold-plated brass contacts, neoprene insert								
Max. conductor cross-section	<table border="1"> <tr> <td>Contact</td> <td>\varnothing</td> </tr> <tr> <td></td> <td>1 mm</td> </tr> <tr> <td>Soldered</td> <td>0,6 mm²</td> </tr> <tr> <td>Crimped*</td> <td>0,6 to 0,93 mm²</td> </tr> </table> <p>* According to the Number of Contacts</p>	Contact	\varnothing		1 mm	Soldered	0,6 mm ²	Crimped*	0,6 to 0,93 mm ²
Contact	\varnothing								
	1 mm								
Soldered	0,6 mm ²								
Crimped*	0,6 to 0,93 mm ²								

Dimensional Data

Panel connector

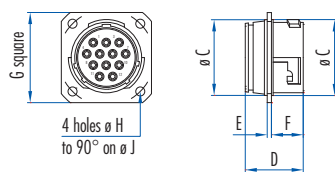

Cable connector

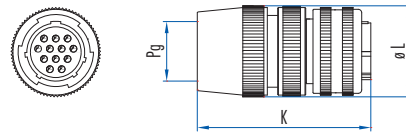

Coupler connector

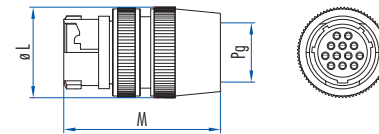

Housing	Number of Contacts	Assembly		Panel connector						Cable connector and Coupler connector				
		A	B	\varnothing C	D	E	F	G	\varnothing H	\varnothing J	K	L	PG	M
1	12-19	53,5	70	21	20,5	1,5	11,5	27	3,2	28	42	26	11	52
2	27-37	63,5	82,5	27	20,5	1,5	11,5	32	3,2	34	59,5	34	16	55
3	55	72,5	100	39	23	2	11,5	43	4,2	48	68,5	44	21	59

Cable connector – Panel connector assembly

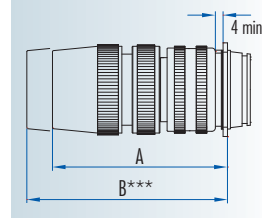

*** B: minimum disconnection distance

Miniature Series – Weatherproof Miniature with ground contact

Part Number

Housing	1	1	2	2	3
Number of Contacts \varnothing 1 mm	12	19	27	37	55

Male panel connectors – Female cable connectors – Male coupler connectors

Square male panel connector	◇533 503 506	◇533 514 506	◇533 513 506	◇533 525 506	◇533 523 506
Female cable connector	637 612 506	637 619 506	637 627 506	637 637 506	637 655 506
Male coupler connector	637 762 506	637 769 506	637 777 506	637 787 506	637 795 506
PG	PG 11	PG 11	PG 16	PG 16	PG 21
Cable clamps	633 421 006	633 421 006	633 422 006	633 422 006	633 423 006
L Capacity of the cable clamp in mm	\varnothing 7 – 12	\varnothing 7 – 12	\varnothing 9 – 17	\varnothing 9 – 17	\varnothing 12,5 – 23
Protective cap for panel connector	630 720 006	630 720 006	536 845 006	536 845 006	536 846 006
Protective cap for cable connector	632 725 006	632 725 006	632 726 006	632 726 006	632 728 006
Protective cap for coupler connector	632 771 006	632 771 006	632 772 006	632 772 006	632 773 006
Flat-Gasket for panel connector (pack of 10)	536 945 006	536 945 006	536 946 006	536 946 006	536 947 006

Complete crimp tool: 579 316 006 (small crimp: \varnothing 1 mm), 579 481 006 (large crimp: \varnothing 1 mm, \varnothing 1,6 mm, \varnothing 2,4 mm)

Tool for insertion and removing contacts 597 104 006

Female panel connectors – Male cable connectors – Female coupler connectors



Square female panel connector	◇533 502 506	◇533 515 506	◇533 512 506	◇533 524 506	◇533 522 506
Male cable connector	637 712 506	637 719 506	637 727 506	637 737 506	637 755 506
Female coupler connector	637 662 506	637 669 506	637 677 506	637 687 506	637 695 506
PG	PG 11	PG 11	PG 16	PG 16	PG 21
Cable clamps	633 421 006	633 421 006	633 422 006	633 422 006	633 423 006
L Capacity of the cable clamp in mm	\varnothing 7 – 12	\varnothing 7 – 12	\varnothing 9 – 17	\varnothing 9 – 17	\varnothing 12,5 – 23
Protective cap for panel connector	630 720 006	630 720 006	536 845 006	536 845 006	536 846 006
Protective cap for cable connector	632 725 006	632 725 006	632 726 006	632 726 006	632 728 006
Protective cap for coupler connector	632 771 006	632 771 006	632 772 006	632 772 006	632 773 006
Flat-Gasket for panel connector (pack of 10)	536 945 006	536 945 006	536 946 006	536 946 006	536 947 006

Complete crimp tool: 579 316 006 (small crimp: \varnothing 1 mm), 579 481 006 (large crimp: \varnothing 1 mm, \varnothing 1,6 mm, \varnothing 2,4 mm)

Tool for insertion and removing contacts 597 104 006

- ◇ Square panel connectors are generally of the „Miniature with ground contact“ type. See page 56.
- Moulded watertight rubber boots for cables are delivered with the connectors. They must be mounted in the cable connectors or coupler connectors.
- Boots for wire-to-wire cables and assemblies are available on request.
- **Important:** All the contacts must be mounted in the insert using our tool.
- For assembly, wiring, panel connector installation and contact arrangement instructions, see: Technical guides;
- Other accessories, see: Accessories.
- Polarisation: Polarisation systems are available to prevent incorrect connection between identical connectors (same series and same contact arrangement). See: Technical guides;
- All connectors are delivered with their contacts.

Miniature Series – Miniature with bulkhead connector

Technical Data		Miniature Series	Weatherproof Miniature Series								
RoHS											
	Bulkhead connector	Cable connector	Coupler connector								
											
Bulkhead connector	male / female contacts										
Cable connector		rectangular housing	circular housing								
Locking		screw up the knurled ring on the cable connector 1/6 of a turn on the panel connector barrel, for frequent locking and unlocking									
Protection	Depending on the associated cable connector	IP 50 to IP 54 with elastomer in the housing and flat-gasket for panel connector	IP 65 with flat-gasket for panel connector								
Contacts	12 to 37 contacts ø 1 mm, removable contacts	12 to 37 contacts ø 1 mm, crimp or solder removable contacts									
Max. current	7 A ø 1 mm										
Mechanical performance	1000 locking and mating cycles										
Contact resistance between pin and socket	< 0,0020 Ω										
Breakdown voltage	at 20 °C, at sea-level: 19 or 37 contacts >2000 Volts (RMS), 12, 27 or 55 contacts >2500 Volts (RMS)										
Insulation resistance	> 5000 MΩ										
Operating temperature		-40 °C to +100 °C (500 hours at +125 °C)									
Materials		Nickel-plated light alloy, gold-plated brass contacts, neoprene insert									
Max. conductor cross-section			<table border="1"> <tr> <td>Contact</td> <td>ø</td> </tr> <tr> <td></td> <td>1 mm</td> </tr> <tr> <td>Soldered</td> <td>0,6 mm²</td> </tr> <tr> <td>Crimped*</td> <td>0,6 to 0,93 mm²</td> </tr> </table>	Contact	ø		1 mm	Soldered	0,6 mm ²	Crimped*	0,6 to 0,93 mm ²
Contact	ø										
	1 mm										
Soldered	0,6 mm ²										
Crimped*	0,6 to 0,93 mm ²										
			* According to the Number of Contacts								

Dimensional Data

Bulkhead connector

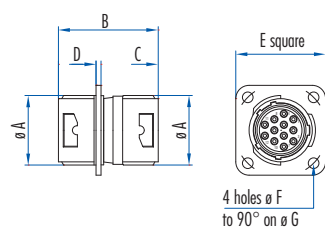

Housing	Number of Contacts	Dimensions in mm							Weight in grams
		ø A	B	C	D	E	ø F	ø G	
1	12-19	21	29	1,5	11,5	27	3,2	28	140
2	27-37	27	30	1,5	11,5	32	3,2	34	203

Miniature Series – Miniature with bulkhead connector

Part Number

Housing	1	1	2	2
Number of Contacts ø 1 mm	12	19	27	37

Bulkhead connector

Bulkhead connector	632 112 006	632 119 006	632 127 006	632 137 006
Protective cap	630 720 006	630 720 006	536 845 006	536 845 006
Flat-Gasket for panel connector (pack of 10)	536 945 006	536 945 006	536 946 006	536 946 006

The electrical connection is made using a cable connector from our „Miniature“ or „Weatherproof Miniature“ Series. Select the most appropriate type of cable connector.

Miniature Series – Female cable connectors – Male cable connectors (see page 48)

Male cable connector	530 503 006	530 505 006	530 513 006	530 521 006
Female cable connector	530 502 006	530 504 006	530 512 006	530 520 006
Type 3 cable clamp	630 135 006	630 135 006	630 138 006	630 138 006
Protective cap for cable connector	632 720 006	632 720 006	532 214 006	532 214 006

Complete crimp tool: 579 316 006 (small crimp: ø 1 mm), 579 481 006 (large crimp: ø 1 mm, ø 1,6 mm, ø 2,4 mm)

Tool for insertion and removing contacts 597 104 006

Weatherproof Miniature Series – Female cable connectors – Male cable connectors (see page 50)

Male cable connector	637 712 006	637 719 006	637 727 006	637 737 006
Female cable connector	637 612 006	637 619 006	637 627 006	637 637 006
Cable clamps	633 421 006	633 421 006	633 422 006	633 422 006
Protective cap for cable connector	632 725 006	632 725 006	632 726 006	632 726 006

Complete crimp tool: 579 316 006 (small crimp: ø 1 mm), 579 481 006 (large crimp: ø 1 mm, ø 1,6 mm, ø 2,4 mm)

Tool for insertion and removing contacts 597 104 006

- The bulkhead connector fitted with male/female contacts allows the installation of a leadthrough which can be disconnected on either side of the partition.
- **Important:** All the contacts must be mounted in the insert using our tool.
- For assembly, wiring, panel connector installation and contact arrangement instructions, see: Technical guides;
- Other accessories, see: Accessories.
- All connectors are delivered with their contacts.

Technical Data

RoHS

Panel connector, cable connector and coupler connector

Panel connector



Cable connector



Coupler connector



Locking	rectangular housing screw up the knurled ring on the cable connector 1/6 of a turn on the panel connector barrel, for frequent locking and unlocking
Protection	IP 50 to IP 54 with conexil in the housing, flat-gasket for panel connector
Contacts	3 to 27 contacts \varnothing 1,6 mm and \varnothing 2,4 mm, crimp or solder removable contacts
Max. current	15 A \varnothing 1,6 mm and 30 A \varnothing 2,4 mm max.
Mechanical endurance	1000 locking and mating cycles
Contact resistance between pin and socket	< 0,0015 Ω 1,6 mm – < 0,0010 Ω 2,4 mm
Breakdown voltage	> 2500 Volts (RMS)
Insulation resistance	> 5000 M Ω
Operating temperature	-40 °C to +100 °C (500 hours at +125 °C)
Materials	Nickel-plated light alloy, gold-plated brass contacts, neoprene insert

Max. conductor cross-section

Contact	\varnothing	\varnothing
	1,6 mm	2,4 mm
Soldered	1,5 mm ²	3,18 mm ²
Crimped*	0,6 to 1,5 mm ²	1,34 to 3,18 mm ²

* According to the Number of Contacts

Dimensional Data

Panel connector

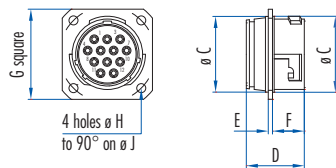

Cable connector

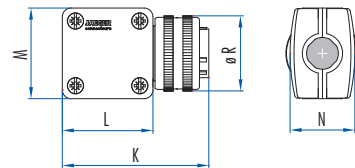

Coupler connector

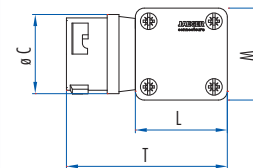

Cable connector – Panel connector assembly

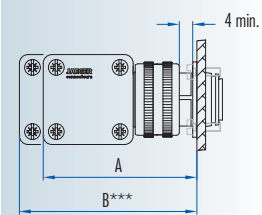

Housing	\varnothing mm	Number of Contacts	Assembly		Panel connector							Cable connector and Coupler connector						
			A	B	\varnothing C	D	E	F	G	\varnothing H	\varnothing J	K	L	M	N	\varnothing R	T	
1	1,6	3-4-7	54	63	21	20,5	1,5	11,5	27	3,2	28	50	32,2	32,2	20,2	25	50,3	
1	2,4	3-4	54	63	21	20,5	1,5	11,5	27	3,2	28	50	32,2	32,2	20,2	25	50,3	
2	1,6	12	58	67	27	20,5	1,5	11,5	32	3,2	34	54	36,4	36,4	23,5	32,5	54,2	
2	2,4	7	58	67	27	20,5	1,5	11,5	32	3,2	34	54	36,4	36,4	23,5	32,5	54,2	
3	1,6	19-27	66	75	39	23	2	11,5	43	4,2	48	61	42,6	47,6	31,3	44	62,1	
3	2,4	12	66	75	39	23	2	11,5	43	4,2	48	61	42,6	47,6	31,3	44	62,1	

*** B: minimum disconnection distance

Part Number

Housing	1	1	1	2	3	3	1	1	2	3
Number of Contacts	3	4	7	12	19	27	3	4	7	12
L ø mm	1,6	1,6	1,6	1,6	1,6	1,6	2,4	2,4	2,4	2,4

Male panel connectors – Female cable connectors – Male coupler connectors

Square male panel connector	630 603 006	630 604 006	630 607 006	630 612 006	630 619 006	630 627 006	630 803 006	630 804 006	630 807 006	630 812 006
Female cable connector	632 603 006	632 604 006	632 607 006	632 612 006	632 619 006	632 627 006	632 803 006	632 804 006	632 807 006	632 812 006
Male coupler connector	633 603 006	633 604 006	633 607 006	633 612 006	633 619 006	633 627 006	633 803 006	633 804 006	633 807 006	633 812 006
Type 3 cable clamp	630 135 006	630 135 006	630 135 006	630 138 006	630 155 006	630 155 006	630 135 006	630 135 006	630 138 006	630 155 006
Flat-Gasket for panel connector (pack of 10)	536 945 006	536 945 006	536 945 006	536 946 006	536 947 006	536 947 006	536 945 006	536 945 006	536 946 006	536 947 006
Protective cap for panel connector	630 720 006	630 720 006	630 720 006	536 845 006	536 846 006	536 846 006	630 720 006	630 720 006	536 845 006	536 846 006
Protective cap for cable connector	632 720 006	632 720 006	632 720 006	532 214 006	532 218 006	532 218 006	632 720 006	632 720 006	532 214 006	532 218 006
Protective cap for coupler connector	533 620 006	533 620 006	533 620 006	533 660 006			533 620 006	533 620 006	533 660 006	

Crimp tool with positioner 579 481 006

Tool for insertion and removing contacts ø 1,6 mm 577 454 006, ø 2,4 mm 577 458 006

Female panel connectors – Male cable connectors – Female coupler connectors

Square female panel connector	630 703 006	630 704 006	630 707 006	630 712 006	630 719 006	630 727 006	630 903 006	630 904 006	630 907 006	630 912 006
Male cable connector	632 703 006	632 704 006	632 707 006	632 712 006	632 719 006	632 727 006	632 903 006	632 904 006	632 907 006	632 912 006
Female coupler connector	633 703 006	633 704 006	633 707 006	633 712 006	633 719 006	633 727 006	633 903 006	633 904 006	633 907 006	633 912 006
Type 3 cable clamp	630 135 006	630 135 006	630 135 006	630 138 006	630 155 006	630 155 006	630 135 006	630 135 006	630 138 006	630 155 006
Flat-Gasket for panel connector (pack of 10)	536 945 006	536 945 006	536 945 006	536 946 006	536 947 006	536 947 006	536 945 006	536 945 006	536 946 006	536 947 006
Protective cap for panel connector	630 720 006	630 720 006	630 720 006	536 845 006	536 846 006	536 846 006	630 720 006	630 720 006	536 845 006	536 846 006
Protective cap for cable connector	632 720 006	632 720 006	632 720 006	532 214 006	532 218 006	532 218 006	632 720 006	632 720 006	532 214 006	532 218 006
Protective cap for coupler connector	533 620 006	533 620 006	533 620 006	533 660 006			533 620 006	533 620 006	533 660 006	

Crimp tool with positioner 579 481 006

Tool for insertion and removing contacts ø 1,6 mm 577 454 006, ø 2,4 mm 577 458 006

- Square panel connectors are also of the „Industrial Weatherproof“ type. See page 64.
- Contact No. 1, which makes the electrical connection before the other contacts and disconnects it after their separation, can be used as a ground contact. If this contact is connected to the housing ground, insert the jumper provided for this purpose at the rear of the two parts of the connector, between the housing and the ground contact.
- Sealable tamper-evident connectors for housings 1 and 2. See: Accessories.
- **Important:** All the contacts must be mounted in the insert using our tool.
- For assembly, wiring, panel connector installation and contact arrangement instructions, see: Technical guides;
- Other accessories, see: Accessories.
- Polarisation: Polarisation systems are available to prevent incorrect connection between identical connectors (same series and same contact arrangement). See: Technical guides;
- All connectors are delivered with their contacts.
- Thermocouple contacts can be fitted. See: Accessories.

Technical Data

RoHS

Panel connector, cable connector and coupler connector

Panel connector



Cable connector



Coupler connector



Locking	circular housing screw up the knurled ring on the cable connector 1/6 of a turn on the panel connector barrel, for frequent locking and unlocking
Protection	IP 65 with flat-gasket for panel connector
Contacts	3 to 27 contacts \varnothing 1,6 mm and \varnothing 2,4 mm, crimp or solder removable contacts
Max. current	15 A \varnothing 1,6 mm and 30 A \varnothing 2,4 mm max.
Mechanical endurance	1000 locking and mating cycles
Contact resistance between pin and socket	$< 0,0015 \Omega$ 1,6 mm – $< 0,0010 \Omega$ 2,4 mm
Breakdown voltage	> 2500 Volts (RMS)
Insulation resistance	> 5000 M Ω
Operating temperature	-40 °C to +100 °C (500 hours at +125 °C)
Materials	Nickel-plated light alloy, gold-plated brass contacts, neoprene insert

Max. conductor cross-section

Contact	\varnothing	\varnothing
	1,6 mm	2,4 mm
Soldered	1,5 mm ²	3,18 mm ²
Crimped*	0,6 to 1,5 mm ²	1,34 to 3,18 mm ²

* According to the Number of Contacts

Dimensional Data

Panel connector

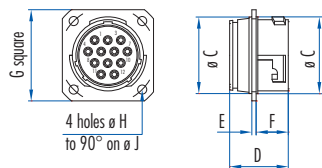

Cable connector

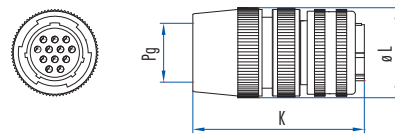

Coupler connector

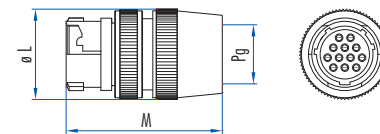

Housing	\varnothing mm	Number of Contacts	Assembly		Panel connector						Cable connector and Coupler connector				
			A	B	\varnothing C	D	E	F	G	\varnothing H	\varnothing J	K	L	PG	M
1	1,6	3-4-7	53,5	70	21	20,5	1,5	11,5	27	3,2	28	42	26	11	52
1	2,4	3-4	53,5	70	21	20,5	1,5	11,5	27	3,2	28	42	26	11	52
2	1,6	12	63,5	82,5	27	20,5	1,5	11,5	32	3,2	34	59,5	34	16	59
2	2,4	7	63,5	82,5	27	20,5	1,5	11,5	32	3,2	34	59,5	34	16	59
3	1,6	19-27	72,5	100	39	23	2	11,5	43	4,2	48	68,5	44	21	65
3	2,4	12	72,5	100	39	23	2	11,5	43	4,2	48	68,5	44	21	65

Cable connector – Panel connector assembly

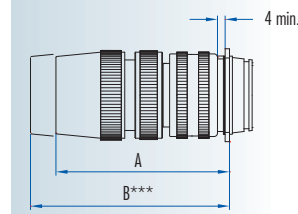

*** B: minimum disconnection distance

Part Number

Housing	1	1	1	2	3	3	1	1	2	3
Number of Contacts	3	4	7	12	19	27	3	4	7	12
L ø mm	1,6	1,6	1,6	1,6	1,6	1,6	2,4	2,4	2,4	2,4

Male panel connectors – Female cable connectors – Male coupler connectors

Square male panel connector	630 603 006	630 604 006	630 607 006	630 612 006	630 619 006	630 627 006	630 803 006	630 804 006	630 807 006	630 812 006
Female cable connector	638 603 006	638 604 006	638 607 006	638 612 006	638 619 006	638 627 006	639 603 006	639 604 006	639 607 006	639 612 006
Male coupler connector	638 753 006	638 754 006	638 757 006	638 762 006	638 769 006	638 777 006	639 753 006	639 754 006	639 757 006	
PG	PG 11	PG 11	PG 11	PG 16	PG 21	PG 21	PG 11	PG 11	PG 16	PG 21
Cable clamps	633 421 006	633 421 006	633 421 006	633 422 006	633 423 006	633 423 006	633 421 006	633 421 006	633 422 006	633 423 006
L Capacity of the cable clamp in mm	ø 7 – 12	ø 7 – 12	ø 7 – 12	ø 9 – 17	ø 12,5 – 23	ø 12,5 – 23	ø 7 – 12	ø 7 – 12	ø 9 – 17	ø 12,5 – 23
Flat-Gasket for panel connector (pack of 10)	536 945 006	536 945 006	536 945 006	536 946 006	536 947 006	536 947 006	536 945 006	536 945 006	536 946 006	536 947 006
Protective cap for panel connector*	630 720 006	630 720 006	630 720 006	536 845 006	536 846 006	536 846 006	630 720 006	630 720 006	536 845 006	536 846 006

Crimp tool with positioner 579 481 006

Tool for insertion and removing contacts ø 1,6 mm 577 454 006, ø 2,4 mm 577 458 006

Female panel connectors – Male cable connectors – Female coupler connectors

Square female panel connector	630 703 006	630 704 006	630 707 006	630 712 006	630 719 006	630 727 006	630 903 006	630 904 006	630 907 006	630 912 006
Male cable connector	638 703 006	638 704 006	638 707 006	638 712 006	638 719 006	638 727 006	639 703 006	639 704 006	639 707 006	639 712 006
Female coupler connector	638 653 006	638 654 006	638 657 006	638 662 006	638 669 006	638 677 006	639 653 006	639 654 006	639 657 006	
PG	PG 11	PG 11	PG 11	PG 16	PG 21	PG 21	PG 11	PG 11	PG 16	PG 21
Cable clamps	633 421 006	633 421 006	633 421 006	633 422 006	633 423 006	633 423 006	633 421 006	633 421 006	633 422 006	633 423 006
L Capacity of the cable clamp in mm	ø 7 – 12	ø 7 – 12	ø 7 – 12	ø 9 – 17	ø 12,5 – 23	ø 12,5 – 23	ø 7 – 12	ø 7 – 12	ø 9 – 17	ø 12,5 – 23
Flat-Gasket for panel connector (pack of 10)	536 945 006	536 945 006	536 945 006	536 946 006	536 947 006	536 947 006	536 945 006	536 945 006	536 946 006	536 947 006
Protective cap for cable connector*	632 725 006	632 725 006	632 725 006	632 726 006	632 728 006	632 728 006	632 725 006	632 725 006	632 726 006	632 728 006
Protective cap for coupler connector	632 771 006	632 771 006	632 771 006	632 772 006	632 773 006	632 773 006	632 771 006	632 771 006	632 772 006	632 773 006



Crimp tool with positioner 579 481 006

Tool for insertion and removing contacts ø 1,6 mm 577 454 006, ø 2,4 mm 577 458 006

* Male / Female

- Square panel connectors are also of the „Industrial“ type. See page 62.
- Contact No. 1, which makes the electrical connection before the other contacts and disconnects it after their separation, can be used as a ground contact.
If this contact is connected to the housing ground, insert the jumper provided for this purpose at the rear of the two parts of the connector, between the housing and the ground contact.
- Moulded watertight rubber boots for cables are delivered with the connectors. They must be mounted in the cable connectors or coupler connector.
- Boots for wire-to-wire cables and assemblies are available on request.
- Other sizes of PG available. Consult us.
- **Important:** All the contacts must be mounted in the insert using our tool.
- For assembly, wiring, panel connector installation and contact arrangement instructions, see: Technical guides;
- Other accessories, see: Accessories.
- Polarisation: Polarisation systems are available to prevent incorrect connection between identical connectors (same series and same contact arrangement). See: Technical guides;
- All connectors are delivered with their contacts.
- Thermocouple contacts can be fitted. See: Accessories.
- Available in a weatherproof high-performance version. Consult us.

Technical Data

	Panel connector	Cable connector	Coupler connector								
Panel connector, cable connector and coupler connector											
Locking	rectangular housing screw up the knurled ring on the cable connector 1/6 of a turn on the panel connector barrel, for frequent locking and unlocking										
Protection	IP 50 to IP 54 with conexil in the housing, flat-gasket for panel connector										
Contacts	3 to 27 contacts \varnothing 1,6 mm crimp or solder removable contacts										
Max. current	15 A \varnothing 1,6 mm										
Mechanical endurance	1000 locking and mating cycles										
Contact resistance between pin and socket	< 0,0015 Ω 1,6 mm										
Breakdown voltage	at 20 °C, at sea-level > 2500 Volts (RMS)										
Insulation resistance	> 5000 M Ω										
Operating temperature	-55 °C to +200 °C (500 hours at +200 °C)										
Materials	Light alloy with olive-green cadmium surface treatment, gold-plated brass contacts, silicon insert										
Max. conductor cross-section	<table border="1"> <tr> <td>Contact</td> <td>\varnothing</td> </tr> <tr> <td></td> <td>1,6 mm</td> </tr> <tr> <td>Soldered</td> <td>1,5 mm²</td> </tr> <tr> <td>Crimped*</td> <td>0,6 to 1,5 mm²</td> </tr> </table>			Contact	\varnothing		1,6 mm	Soldered	1,5 mm ²	Crimped*	0,6 to 1,5 mm ²
Contact	\varnothing										
	1,6 mm										
Soldered	1,5 mm ²										
Crimped*	0,6 to 1,5 mm ²										
	* According to the Number of Contacts										

Dimensional Data

Panel connector

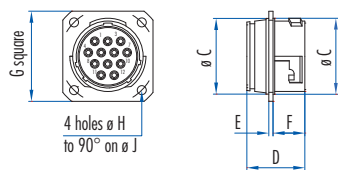

Cable connector

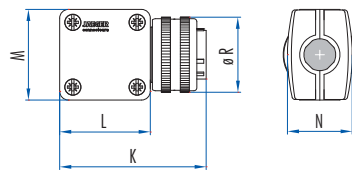

Coupler connector

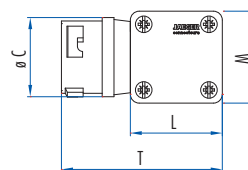

Cable connector – Panel connector assembly

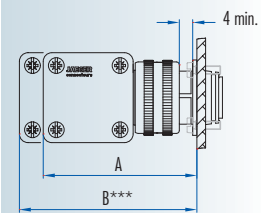

Housing	Number of Contacts	Assembly		Panel connector						Cable connector / Coupler connector						
		A	B	\varnothing C	D	E	F	G	\varnothing H	\varnothing J	K	L	M	N	\varnothing R	T
1	3-4-7	54	63	21	20,5	1,5	11,5	27	3,2	28	50	32,2	32,2	20,2	25	50,3
2	12	58	67	27	20,5	1,5	11,5	32	3,2	34	54	36,4	36,4	23,5	32,5	54,2
3	19-27	66	75	39	23	2	11,5	43	4,2	48	61	42,6	47,6	31,3	44	62,1

*** B: minimum disconnection distance

Part Number

Housing	1	1	1	2	3	3
Number of Contacts ø 1,6 mm	3	4	7	12	19	27

Male panel connectors – Female cable connectors – Male coupler connectors

Square male panel connector	630 603 256	630 604 256	630 607 256	630 612 256		
Female cable connector	632 603 256	632 604 256	632 607 256	632 612 256		
Male coupler connector	633 603 256	633 604 256	633 607 256	633 612 256		
Type 3 cable clamp	630 135 256	630 135 256	630 135 256	630 138 256		
Flat-Gasket for panel connector (pack of 10)	536 945 026	536 945 026	536 945 026	536 946 026		
Protective cap for panel connector	630 720 256	630 720 256	630 720 256	536 845 256		
Protective cap for cable connector	632 720 256	632 720 256	632 720 256			

Crimp tool with positioner 579 481 006

Tool for insertion and removing contacts ø 1,6 mm 577 454 006

Female panel connectors – Male cable connectors – Female coupler connectors

Square female panel connector	630 703 256	630 704 256	630 707 256	630 712 256	630 719 256	630 727 256
Male cable connector	632 703 256	632 704 256	632 707 256	632 712 256	632 719 256	632 727 256
Female coupler connector	633 703 256	633 704 256	633 707 256	633 712 256		
Type 3 cable clamp	630 135 256	630 135 256	630 135 256	630 138 256		
Flat-Gasket for panel connector (pack of 10)	536 945 026	536 945 026	536 945 026	536 946 026		
Protective cap for panel connector	630 720 256	630 720 256	630 720 256	536 845 256	536 846 256	536 846 256
Protective cap for cable connector	632 720 256	632 720 256	632 720 256			

Crimp tool with positioner 579 481 006

Tool for insertion and removing contacts ø 1,6 mm 577 454 006

- Contact No. 1, which makes the electrical connection before the other contacts and disconnects it after their separation can be used as a ground contact.
If this contact is connected to the housing ground, insert the jumper provided for this purpose at the rear of the two parts of the connector between the housing and the ground contact.
- Sealable tamper-evident connectors for housings 1 and 2. See: Accessories.
- **Important:** All the contacts must be mounted in the insert using our tool.
- For assembly, wiring, panel connector installation and contact arrangement instructions, see: Technical guides;
- Other accessories, see: Accessories.
- Polarisation: Polarisation systems are available to prevent incorrect connection between identical connectors (same series and same contact arrangement). See: Technical guides;
- All connectors are delivered with their contacts.
- Thermocouple contacts can be fitted. See: Accessories.
- Available in a weatherproof high-performance version. Consult us.

Technical Data

RoHS

Panel connector, cable connector
and coupler connector

Locking

Protection

Contacts

Max. current

Contact resistance between pin and socket

Breakdown voltage

Insulation resistance

Operating temperature

Materials

Max. conductor cross-section

Panel connector



Cable connector



rectangular housing (IP 50 – 54) or circular housing (IP 65)

screw up the knurled ring on the cable connector 1/6 of a turn on the panel connector barrel, for frequent locking and unlocking

IP 50 to IP 54 with conexit in the housing, flat-gasket for panel connector and IP 65 with flat-gasket for panel connector

17 contacts: 13 contacts \varnothing 1 mm and 4 contacts \varnothing 2,4 mm, crimp or solder removable contacts

7 A \varnothing 1 mm and 30 A \varnothing 2,4 mm

$< 0,0015 \Omega$ 1 mm – $< 0,0010 \Omega$ 2,4 mm

at 20 °C, at sea-level 13 contacts \varnothing 1 mm > 2500 Volts (RMS), 4 contacts \varnothing 2,4 mm > 2500 Volts (RMS)

> 5000 M Ω

-40 °C to +100 °C (500 hours at +125 °C)

Nickel-plated light alloy, gold-plated brass contacts, neoprene insert

Contact	\varnothing	\varnothing
	1 mm	2,4 mm
Soldered	0,6 mm ²	3,18 mm ²
Crimped*	0,6 to 0,93 mm ²	1,34 to 3,18 mm ²

* According to the Number of Contacts

Dimensional Data

Panel connector

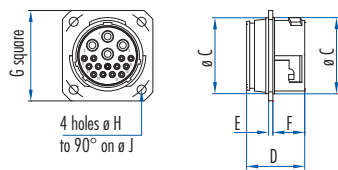

Cable connector

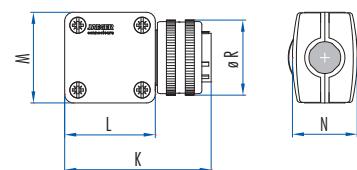

Coupler connector

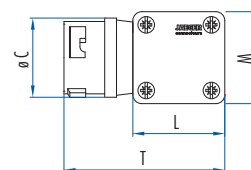

Cable connector – Panel connector assembly

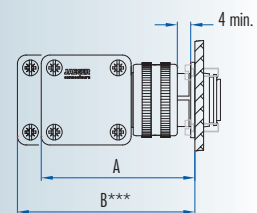

Housing	Number of Contacts	Assembly		Panel connector						Cable connector and Coupler connector						
		A	B	\varnothing C	D	E	F	G	\varnothing H	\varnothing J	K	L	M	N	\varnothing R	T
2	17	58	67	27	20,5	1,5	11,5	32	3,2	34	54	36,4	36,4	23,5	32,5	54,2

- Contact No. 1, which makes the electrical connection before the other contacts and disconnects it after their separation can be used as a ground contact.

If this contact is connected to the housing ground, insert the jumper provided for this purpose at the rear of the two parts of the contactor between the housing and the ground contact.

- **Important:** All the contacts must be mounted in the insert using our tool.

- For assembly, wiring, panel connector installation and contact arrangement instructions, see: Technical guides;

- Other accessories, see: Accessories.

- All connectors are delivered with their contacts.

*** B: minimum disconnection distance

Part Number

Housing	2
Number of Contacts	17
L ø 1 mm	13
L ø 2,4 mm	4

Rectangular housing IP 50–54: Male panel connector – Female cable connector – Male coupler connector

IP	50-54
Square male panel connector	630 617 006
Female cable connector	632 617 006
Male coupler connector	
Type 3 cable clamp	630 138 006
Flat-Gasket for panel connector (pack of 10)	536 946 006
Protective cap for panel connector	536 845 006
Protective cap for cable connector	532 214 006
Crimp tool with positioner 579 481 006	
Tool for insertion and removing contacts ø 1 mm 597 104 206, ø 2,4 mm 577 458 006	

Rectangular housing IP 50–54: Female panel connector – Male cable connector – Female coupler connector



IP	50-54
Square female panel connector	630 717 006
Male cable connector	632 717 006
Female coupler connector	
Type 3 cable clamp	630 138 006
Flat-Gasket for panel connector (pack of 10)	536 946 006
Protective cap for panel connector	536 845 006
Protective cap for cable connector	532 214 006
Crimp tool with positioner 579 481 006	
Tool for insertion and removing contacts ø 1 mm 597 104 206, ø 2,4 mm 577 458 006	

Circular housing IP 65: Male panel connector – Female cable connector – Male coupler connector

IP	65
Square male panel connector	630 617 006
Female cable connector	PG 16 638 217 006
Male coupler connector	PG 16 638 417 006
Cable clamp	capacity: 9 mm min. – 17 mm max. 633 422 006
Flat-Gasket for panel connector (pack of 10)	536 946 006
Protective cap for panel connector	536 845 006
Protective cap for cable connector	632 726 006
Crimp tool with positioner 579 481 006	
Tool for insertion and removing contacts ø 1 mm 597 104 206, ø 2,4 mm 577 458 006	

Circular housing IP 65: Female panel connector – Male cable connector – Female coupler connector

IP	65
Square female panel connector	630 717 006
Male cable connector	PG 16 638 317 006
Female coupler connector	PG 16 638 517 006
Type 3 cable clamp	capacity: 9 mm min. – 17 mm max. 633 422 006
Flat-Gasket for panel connector	536 946 006
Protective cap for panel connector	536 845 006
Protective cap for cable connector	632 726 006
Crimp tool with positioner 579 481 006	
Tool for insertion and removing contacts ø 1 mm 597 104 206, ø 2,4 mm 577 458 006	

Technical Data		Industrial Series	Industrial Weatherproof Series									
RoHS	Bulkhead connector	Cable connector	Cable connector									
												
Bulkhead connector	male / female contacts											
Cable connector		rectangular housing	circular housing									
Locking		screw up the knurled ring on the cable connector 1/6 of a turn on the panel connector barrel, for frequent locking and unlocking										
Protection	Depending on the associated cable connector	IP 50 to IP 54 with elastomer in the housing, flat-gasket for panel connector	IP 65 with flat-gasket for panel connector									
Contacts	3, 4, 7 and 12 contacts \varnothing 1,6 mm, 3, 4 and 7 contacts \varnothing 2,4 mm, removable contacts	3, 4, 7 and 12 contacts \varnothing 1,6 mm, 3, 4 and 7 contacts \varnothing 2,4 mm, crimp or solder removable contacts										
Max. current	15 A \varnothing 1,6 mm, 30 A \varnothing 2,4 mm											
Contact resistance between pin and socket	$< 0,0015 \Omega$ \varnothing 1,6 mm – $< 0,0010 \Omega$ \varnothing 2,4 mm											
Breakdown voltage	at 20 °C, at sea-level: >2500 Volts (RMS)											
Insulation resistance	> 5000 M Ω											
Operating temperature		-40 °C to +100 °C (500 hours at +125 °C)										
Materials		Nickel-plated light alloy, gold-plated brass contacts, neoprene insert										
Mechanical endurance	1 000 locking and mating cycles											
Max. conductor cross-section		<table border="1"> <thead> <tr> <th>Contact</th> <th>\varnothing</th> <th>\varnothing</th> </tr> </thead> <tbody> <tr> <td>Soldered</td> <td>1,6 mm</td> <td>2,4 mm</td> </tr> <tr> <td>Crimped*</td> <td>0,6 to 1,5 mm²</td> <td>1,34 to 3,18 mm²</td> </tr> </tbody> </table>		Contact	\varnothing	\varnothing	Soldered	1,6 mm	2,4 mm	Crimped*	0,6 to 1,5 mm ²	1,34 to 3,18 mm ²
Contact	\varnothing	\varnothing										
Soldered	1,6 mm	2,4 mm										
Crimped*	0,6 to 1,5 mm ²	1,34 to 3,18 mm ²										
		* According to the Number of Contacts										

Dimensional Data

Bulkhead connector

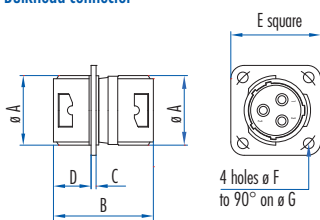

Housing	Dimensions in mm							Weight in grams
	\varnothing A	B	C	D	E	\varnothing F	\varnothing G	
1	21	29	1,5	11,5	27	3,2	28	140
2	27	30	1,5	11,5	32	3,2	34	203

Part Number

Housing	1	1	1	2	1	1	2
Number of Contacts	3	4	7	12	3	4	7
L ø mm	1,6	1,6	1,6	1,6	2,4	2,4	2,4

Bulkhead connector

Bulkhead connector	632 503 006	632 504 006	632 507 006	632 512 006	632 553 006	632 554 006	632 557 006
Protective cap	630 720 006	630 720 006	630 720 006	536 845 006	630 720 006	630 720 006	536 845 006
Flat-Gasket for bulkhead connector (pack of 10)	536 945 006	536 945 006	536 945 006	536 946 006	536 945 006	536 945 006	536 946 006

The electrical connection is made using a cable connector from our „Industrial“ or „Industrial Weatherproof“ Series. Select the most appropriate type of cable connector.

Industrial Series – Female cable connectors – Male cable connectors (see page 58)

Male cable connector	632 703 006	632 704 006	632 707 006	632 712 006	632 903 006	632 904 006	632 907 006
Female cable connector	632 603 006	632 604 006	632 607 006	632 612 006	632 803 006	632 804 006	632 807 006
Type 3 cable clamp	630 135 006	630 135 006	630 135 006	630 138 006	630 135 006	630 135 006	630 138 006
Protective cap for cable connector	632 720 006	632 720 006	632 720 006	532 214 006	632 720 006	632 720 006	532 214 006

Crimp tool with positioner 579 481 006

Tool for insertion and removing contacts ø 1,6 mm 577 454 006, ø 2,4 mm 577 458 006

Industrial Weatherproof Series – Female cable connectors – Male cable connectors (see page 60)

Male cable connector	638 703 006	638 704 006	638 707 006	638 712 006	639 703 006	639 704 006	639 707 006
Female cable connector	638 603 006	638 604 006	638 607 006	638 612 006	639 603 006	639 604 006	639 607 006
Cable clamps	633 421 006	633 421 006	633 421 006	633 422 006	633 421 006	633 421 006	633 422 006
Protective cap for cable connector	632 725 006	632 725 006	632 725 006	632 726 006	632 725 006	632 725 006	632 726 006

Crimp tool with positioner 579 481 006

Tool for insertion and removing contacts ø 1,6 mm 577 454 006, ø 2,4 mm 577 458 006

- The bulkhead connector fitted with male / female contacts allows the installation of a leadthrough which can be disconnected on either side of the partition.
- Version (High-Performance) of the bulkhead connector available. Consult us.
- **Important:** All the contacts must be mounted in the insert using our tool.
- For assembly, wiring, panel connector installation and contact arrangement instructions, see: Technical guides;
- Other accessories, see: Accessories.
- All connectors are delivered with their contacts.

Technical Data

RoHS

Panel connector, cable connector and coupler connector

Panel connector



Cable connector



Coupler connector



Panel connector, cable connector and coupler connector	circular housing
Locking	screw connection
Protection	IP 68 with flat-gasket for panel connector
Contacts	3 to 37 contacts \varnothing 1 mm – \varnothing 1,6 mm – \varnothing 2,4 mm crimp or solder removable contacts
Max. current	7 A \varnothing 1 mm – 15 A \varnothing 1,6 mm – 30 A \varnothing 2,4 mm
Contact resistance between pin and socket	$< 0,0020 \Omega$ \varnothing 1 mm – $< 0,0015 \Omega$ \varnothing 1,6 mm – $< 0,0010 \Omega$ \varnothing 2,4 mm
Breakdown voltage	at 20°C, at sea-level: 4, 19 or 37 contacts \varnothing 1 mm > 2000 Volts (RMS) 3, 7, 12, 19, 27 contacts \varnothing 1 mm > 2500 Volts (RMS) \varnothing 1,6 mm > 2500 Volts (RMS) – \varnothing 2,4 mm > 2500 Volts (RMS)
Insulation resistance	$> 5000 \text{ M}\Omega$
Operating temperature	-40°C to +100°C (500 hours at +125°C)
Materials	ARCAP (stainless steel), gold-plated brass contacts, neoprene insert
Mechanical endurance	1000 locking and mating cycles
Weatherproof to	10 bar= 100 m (15 bar max.)
Salt spray resistance	500 hours

Max. conductor cross-section

Contact	\varnothing 1 mm	\varnothing 1,6 mm	\varnothing 2,4 mm
Soldered	0,6 mm ²	1,5 mm ²	3,18 mm ²
Crimped*	0,6 to 0,93 mm ²	0,6 to 1,5 mm ²	1,34 to 3,18 mm ²

* According to the Number of Contacts

Dimensional Data

Square panel connector

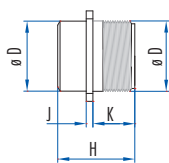
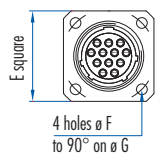

Round panel connector

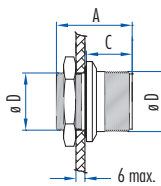
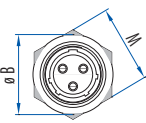

Cable connector

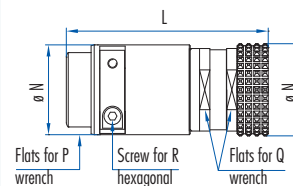

Coupler connector

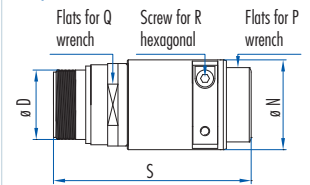

Housing	Round panel connector					Square panel connector					Cable connector / Coupler connector							
	A	\varnothing B	C	\varnothing D	M	\varnothing D	E	\varnothing F	\varnothing G	H	J	K	L	\varnothing N	O	P	R	S
1	26,5	28	16	M21	24	M21	27	3,2	28	23	2	12,5	70	29	26	24	2,5	69
2	27	40	16	M27	32	M27	32	3,2	34	23,5	2	12,5	78	36	32	30	3	80

Part Number

Housing	1	1	2	2	1	1	1	2	1	1	2
Number of Contacts	12	19	27	37	3	4	7	12	3	4	7
L ø mm	1	1	1	1	1,6	1,6	1,6	1,6	2,4	2,4	2,4

Male panel connectors – Female cable connectors – Male coupler connectors

Circular male panel connector					637 203 606	637 204 606	637 207 606	637 212 606			
Square male panel connector	637 012 006	637 019 006	637 027 006	637 037 006	637 203 006	637 204 006	637 207 006	637 212 006	637 403 006	637 404 006	637 407 006
Female cable connector	638 012 006	638 019 006	638 027 006	638 037 006	638 203 006	638 204 006	638 207 006	638 212 006	638 403 006	638 404 006	638 407 006
Male coupler connector	639 012 006	639 019 006	639 027 006	639 037 006	639 203 006	639 204 006	639 207 006	639 212 006	639 403 006	639 404 006	639 407 006
Capacity of the cable clamp	ø 9 – 14	ø 9 – 14	ø 12 – 18	ø 12 – 18	ø 9 – 14	ø 9 – 14	ø 9 – 14	ø 12 – 18	ø 9 – 14	ø 9 – 14	ø 12 – 18
Flat-Gasket for panel connector	536 945 006	536 945 006	536 946 006	536 946 006	536 945 006	536 945 006	536 945 006	536 946 006	536 945 006	536 945 006	536 946 006
L (pack of 10)											
Protective cap for panel connector	637 820 006	637 820 006	637 825 006	637 825 006	637 820 006	637 820 006	637 820 006	637 825 006	637 820 006	637 820 006	637 825 006
Protective cap for cable connector	638 820 006	638 820 006	638 825 006	638 825 006	638 820 006	638 820 006	638 820 006	638 825 006	638 820 006	638 820 006	638 825 006
Protective cap for panel connector	637 820 436	637 820 436	637 825 436	637 825 436	637 820 436	637 820 436	637 820 436	637 825 436	637 820 436	637 820 436	637 825 436

Crimp tool with positioner 579 481 006

Tool for insertion and removing contact ø 1 mm 597 104 006, ø 1,6 mm 577 454 006, ø 2,4 mm 577 458 006

Female panel connectors – Male cable connectors – Female coupler connectors

Circular female panel connector					637 303 606	637 304 606	637 307 606	637 312 606			
Square female panel connector	637 112 006	637 119 006	637 127 006	637 137 006	637 303 006	637 304 006	637 307 006	637 312 006	637 503 006	637 504 006	637 507 006
Male cable connector	638 112 006	638 119 006	638 127 006	638 137 006	638 303 006	638 304 006	638 307 006	638 312 006	638 503 006	638 504 006	638 507 006
Female coupler connector	639 112 006	639 119 006	639 127 006	639 137 006	639 303 006	639 304 006	639 307 006	639 312 006	639 503 006	639 504 006	639 507 006
Capacity of the cable clamp	ø 9 – 14	ø 9 – 14	ø 12 – 18	ø 12 – 18	ø 9 – 14	ø 9 – 14	ø 9 – 14	ø 12 – 18	ø 9 – 14	ø 9 – 14	ø 12 – 18
Flat-Gasket for panel connector	536 945 006	536 945 006	536 946 006	536 946 006	536 945 006	536 945 006	536 945 006	536 946 006	536 945 006	536 945 006	536 946 006
L (pack of 10)											
Protective cap for panel connector	637 820 006	637 820 006	637 825 006	637 825 006	637 820 006	637 820 006	637 820 006	637 825 006	637 820 006	637 820 006	637 825 006
Protective cap for cable connector	638 820 006	638 820 006	638 825 006	638 825 006	638 820 006	638 820 006	638 820 006	638 825 006	638 820 006	638 820 006	638 825 006
Protective cap for panel connector	637 820 436	637 820 436	637 825 436	637 825 436	637 820 436	637 820 436	637 820 436	637 825 436	637 820 436	637 820 436	637 825 436

Crimp tool with positioner 579 481 006

Tool for insertion and removing contact ø 1 mm 597 104 006, ø 1,6 mm 577 454 006, ø 2,4 mm 577 458 006

- ø 1,6 mm and ø 2,4 mm, contact No. 1, which makes the electrical connection before the other contacts and disconnects it after their separation, can be used as a ground contact.
- Improved operating temperature -55 °C to + 200 °C available. Consult us.
- **Important:** All the contacts must be mounted in the insert using our tool.
- For assembly, wiring, panel connector installation and contact arrangement instructions, see: Technical guides;
- Other accessories, see: Accessories.
- All connectors are delivered with their contacts.
- Thermocouple contacts can be fitted. See: Accessories.

Technical Data

RoHS

Panel connector



Cable connector



Coupler connector



Panel connector, cable connector
and coupler connector

Panel connector, cable connector and coupler connector	circular housing
Locking	screw connection
Protection	IP 68 with flat-gasket for panel connector
Contacts	7 to 19 contacts \varnothing 0,76 mm, 3 to 37 contacts \varnothing 1 mm, 3 to 12 contacts \varnothing 1,6 mm, 3 to 7 contacts \varnothing 2,4 mm removable contacts, can be crimped or soldered
Max. current	5 A \varnothing 0,76 mm – 7 A \varnothing 1 mm – 15 A \varnothing 1,6 mm – 30 A \varnothing 2,4 mm
Contact resistance between pin and socket	< 3m Ω \varnothing 1 mm – < 2m Ω \varnothing 1 mm – < 1,5m Ω \varnothing 1,6 mm – < 1m Ω \varnothing 2,4 mm
Immersion	10 Bar (10 Bar= 100 M)
Breakdown voltage	\varnothing 0,76 mm >1500 V (RMS) – \varnothing 1 mm >2000 V (RMS) \varnothing 1,6 mm >2500 V (RMS) – \varnothing 2,4 mm >2500 V (RMS)
Insulation resistance	> 5000 M Ω
Operating temperature	-40 °C to +100 °C
Materials	303 stainless steel, gold-plated brass contacts, neoprene insert

Max. conductor cross-section

Contact	\varnothing	\varnothing	\varnothing	\varnothing
	0,76 mm	1 mm	1,6 mm	2,4 mm
Soldered		0,6 mm ²	1,5 mm ²	3,18 mm ²
Crimped*	0,34 mm ²	0,6 to 0,93 mm ²	0,6 to 1,5 mm ²	1,34 to 3,18 mm ²

* According to the Number of Contacts

Dimensional Data

Square panel connector

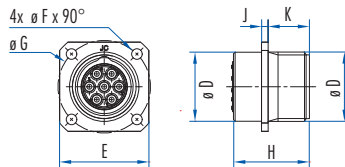

Cable connector

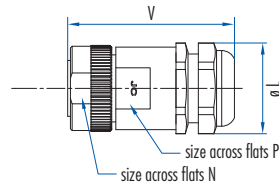

Coupler connector

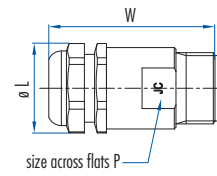

Cable connector – Panel connector assembly

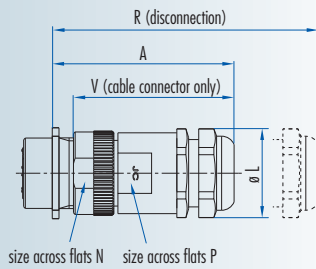

Cable connector – Cable coupler connector assembly

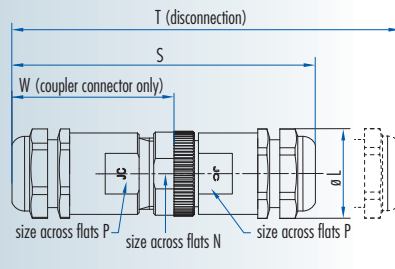

Housing	Assembly				Square panel connector							Cable connector / Coupler connector						
	A	R	S	T	ø D	E	ø F	ø G	H	J	K	ø L	N	P	V	W		
00	52	61	85	93	12	18	2,7	18	17	1,5	11,3	16	14	12	47	46		
0	56	60	92	100	16	20	2,7	21	17	1,5	11,3	25	18	19	50	49		
1	61	70	102	111	21	27	3,2	28	23	2	12,5	27	23	21	54	57		
2	61	70	104	113	27	32	3,2	34	23	2	12,5	33	30	27	55	58		

Male panel connectors – Female cable connectors – Male coupler connectors

Housing	00	0	0	0
Number of Contacts \varnothing 0,76 mm	7	8	12	19

Male panel connectors – Female cable connectors – Male coupler connectors

Square male panel connector	680 607 006	680 608 006	680 612 006	680 619 006
Female cable connector	681 607 006	681 608 006	681 612 006	681 619 006
Male coupler connector	682 607 006	682 608 006	682 612 006	682 619 006

Crimp tool: 630 180 006 + positioner \varnothing 0.76 mm: 769 100 006. Tool for insertion and removing contacts \varnothing 0,76 mm 769 131 006.

Housing	00	00	0	1	1	2	2
Number of Contacts \varnothing 1 mm	3	4	7	12	19	27	37

Male panel connectors – Female cable connectors – Male coupler connectors

Square male panel connector	680 803 006	680 804 006	680 807 006	680 012 006	680 019 006	680 027 006	680 037 006
Female cable connector	681 803 006	681 804 006	681 807 006	681 012 006	681 019 006	681 027 006	681 037 006
Male coupler connector	682 803 006	682 804 006	682 807 006	682 012 006	682 019 006	682 027 006	682 037 006

Crimp tool with positioner \varnothing 1 mm: 579 316 006. Tool for insertion and removing contacts \varnothing 1 mm 597 104 006.

Housing	1	1	1	2
Number of Contacts \varnothing 1,6 mm	3	4	7	12

Male panel connectors – Female cable connectors – Male coupler connectors

Square male panel connector	680 203 006	680 204 006	680 207 006	680 212 006
Female cable connector	681 203 006	681 204 006	681 207 006	681 212 006
Male coupler connector	682 203 006	682 204 006	682 207 006	682 212 006

Crimp tool with positioner \varnothing 1,6 mm: 579 481 006. Tool for insertion and removing contacts \varnothing 1 mm 577 454 006.

Housing	1	1	2
Number of Contacts \varnothing 2,4 mm	3	4	7

Male panel connectors – Female cable connectors – Male coupler connectors

Square male panel connector	680 403 006	680 404 006	680 407 006
Female cable connector	681 403 006	681 404 006	681 407 006
Male coupler connector	682 403 006	682 404 006	682 407 006

Crimp tool with positioner \varnothing 2,4 mm: 579 481 006. Tool for insertion and removing contacts \varnothing 1 mm 577 458 006.

Housing	00	0	1	2
Flat-Gasket for panel connector (pack of 10)	533 328 006	533 368 006	536 945 006	536 946 006
Cable gland, small outlet	680 001 216	680 001 186	680 001 116	680 001 136
L Capacity of the cable gland in mm	\varnothing 2–5	\varnothing 3–7	\varnothing 7–12	\varnothing 9–16
Cable gland, large outlet	680 001 176	680 001 196	680 001 126	680 001 156
L Capacity of the cable gland in mm	\varnothing 3–6,5	\varnothing 5–10	\varnothing 10–14	\varnothing 13–18
Protective cap for panel connector	680 007 006	680 007 906	680 001 006	680 002 006
Protective cap for cable connector	680 008 006	680 008 906	680 003 006	680 004 006
Protective cap for coupler connector	680 009 006	680 009 906	680 005 006	680 006 006

- \varnothing 1,6 mm and \varnothing 2,4 mm, contact No. 1, which makes the electrical connection before the other contacts and disconnects it after their separation, can be used as a ground contact.
- All connectors are delivered with their contacts.
- N.B. These connectors can be fitted with an „ethylene propylene“ insert for use in power applications. Consult us.

- **Important:** All the contacts must be mounted in the insert using our tool.
- For assembly, wiring, panel connector installation and contact arrangement instructions, see: Technical guides;
- Other accessories, see: Accessories.
- Thermocouple contacts can be fitted. See: Accessories.

Female panel connectors – Male cable connectors – Female coupler connectors

Housing	00	0	0	0
Number of Contacts \varnothing 0,76 mm	7	8	12	19

Female panel connectors – Male cable connectors – Female coupler connectors

Square female panel connector	680 707 006	680 708 006	680 712 006	680 719 006
Male cable connector	681 707 006	681 708 006	681 712 006	681 719 006
Female coupler connector	682 707 006	682 708 006	682 712 006	682 719 006

Crimp tool: 630 180 006 + positioner \varnothing 0,76 mm: 769 100 006. Tool for insertion and removing contacts \varnothing 0,76 mm 769 131 006.

Housing	00	00	0	1	1	2	2
Number of Contacts \varnothing 1 mm	3	4	7	12	19	27	37

Female panel connectors – Male cable connectors – Female coupler connectors

Square female panel connector	680 903 006	680 904 006	680 907 006	680 112 006	680 119 006	680 127 006	680 137 006
Male cable connector	681 903 006	681 904 006	681 907 006	681 112 006	681 119 006	681 127 006	681 137 006
Female coupler connector	682 903 006	682 904 006	682 907 006	682 112 006	682 119 006	682 127 006	682 137 006

Crimp tool with positioner \varnothing 1 mm: 579 316 006. Tool for insertion and removing contacts \varnothing 1 mm 597 104 006.

Housing	1	1	1	2
Number of Contacts \varnothing 1,6 mm	3	4	7	12

Female panel connectors – Male cable connectors – Female coupler connectors

Square female panel connector	680 303 006	680 304 006	680 307 006	680 312 006
Male cable connector	681 303 006	681 304 006	681 307 006	681 312 006
Female coupler connector	682 303 006	682 304 006	682 307 006	682 312 006

Crimp tool with positioner \varnothing 1,6 mm: 579 481 006. Tool for insertion and removing contacts \varnothing 1 mm 577 454 006.

Housing	1	1	2
Number of Contacts \varnothing 2,4 mm	3	4	7

Female panel connectors – Male cable connectors – Female coupler connectors

Square female panel connector	680 503 006	680 504 006	680 507 006
Male cable connector	681 503 006	681 504 006	681 507 006
Female coupler connector	682 503 006	682 504 006	682 507 006

Crimp tool with positioner \varnothing 2,4 mm: 579 481 006. Tool for insertion and removing contacts \varnothing 1 mm 577 458 006.

Housing	00	0	1	2
Flat-Gasket for panel connector (pack of 10)	533 328 006	533 368 006	536 945 006	536 946 006
Cable gland, small outlet	680 001 216	680 001 186	680 001 116	680 001 136
└ Capacity of the cable gland in mm	\varnothing 2–5	\varnothing 3–7	\varnothing 7–12	\varnothing 9–16
Cable gland, large outlet	680 001 176	680 001 196	680 001 126	680 001 156
└ Capacity of the cable gland in mm	\varnothing 3–6,5	\varnothing 5–10	\varnothing 10–14	\varnothing 13–18
Protective cap for panel connector	680 007 006	680 007 906	680 001 006	680 002 006
Protective cap for cable connector	680 008 006	680 008 906	680 003 006	680 004 006
Protective cap for coupler connector	680 009 006	680 009 906	680 005 006	680 006 006

- \varnothing 1,6 mm and \varnothing 2,4 mm, contact No. 1, which makes the electrical connection before the other contacts and disconnects it after their separation, can be used as a ground contact.
- All connectors are delivered with their contacts.
- N.B. These connectors can be fitted with an „ethylene propylene“ insert for use in power applications. Consult us.

- **Important:** All the contacts must be mounted in the insert using our tool.
- For assembly, wiring, panel connector installation and contact arrangement instructions, see: Technical guides;
- Other accessories, see: Accessories.
- Thermocouple contacts can be fitted. See: Accessories.

Technical Data

RoHS

Panel connector, cable connector and coupler connector

Panel connector



Cable connector



Coupler connector



Panel connector, cable connector and coupler connector	rectangular housing
Locking	screw connection
Protection	IP 50 to IP 54 with conexil in the housing, flat-gasket for panel connector (supplied with the panel connector)
Contacts	3 to 37 contacts \varnothing 1 mm – \varnothing 1,6 mm – \varnothing 2,4 mm crimp or solder removable contacts
Max. current	7 A \varnothing 1 mm – 15 A \varnothing 1,6 mm – 30 A \varnothing 2,4 mm
Contact resistance between pin and socket	$< 0,0020 \Omega$ \varnothing 1 mm – $< 0,0015 \Omega$ \varnothing 1,6 mm – $< 0,0010 \Omega$ \varnothing 2,4 mm
Breakdown voltage	at 20°C, at sea-level: \varnothing 1 mm > 2000 Volts (RMS) 1,6 mm > 2500 Volts (RMS) – \varnothing 2,4 mm > 2500 Volts (RMS)
Insulation resistance	$> 5000 \text{ M}\Omega$
Operating temperature	-40°C to +100°C (500 hours at +125°C)
Materials	Nickel-plated alloy, gold-plated brass contacts, neoprene insert
Mechanical endurance	1000 locking and mating cycles

Max. conductor cross-section

Contact	\varnothing	\varnothing	\varnothing
	1 mm	1,6 mm	2,4 mm
Soldered	0,6 mm ²	1,5 mm ²	3,18 mm ²
Crimped*	0,6 to 0,93 mm ²	0,6 to 1,5 mm ²	1,34 to 3,18 mm ²

* According to the Number of Contacts

Dimensional Data

Panel connector

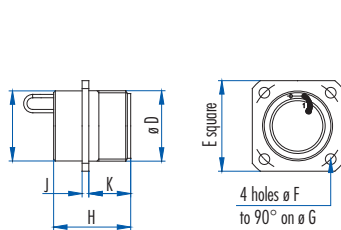

Panel connector and Cable connector

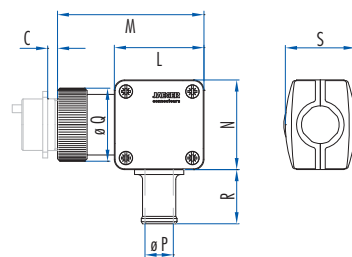

Cable connector and Coupler connector

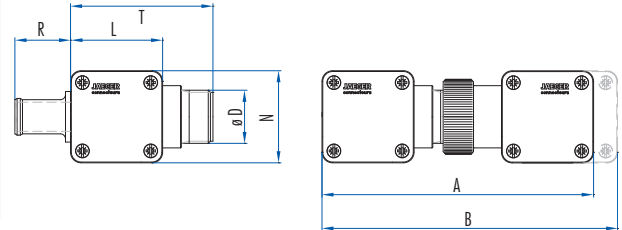

Housing	Assembly		Panel connector – Cable connector – Coupler connector														Cable clamp	
	A	B	C	\varnothing D	E	\varnothing F	\varnothing G	H	J	K	L	M	N	\varnothing Q	S	T	\varnothing P	R
1	108	118	4	M21	27	3,2	28	23	2	12,5	36,4	56,6	36,4	30	23,5	57	depending on the model	22
2			4	M27	32	3,2	34	23	2	12,5	42,6	62,8	47,6	36	31,3	64	depending on the model	30

Part Number

Housing	1	1	2	2	1	1	1	2	1	1	2
Number of Contacts	12	19	27	37	3	4	7	12	3	4	7
L ø mm	1	1	1	1	1,6	1,6	1,6	1,6	2,4	2,4	2,4

Male panel connectors – Female cable connectors – Male coupler connectors

Square male panel connector	637 012 506	637 019 506	637 027 506	637 037 506							637 404 506
Female cable connector*	638 072 006	638 079 506	638 087 506	638 097 506			638 774 506				638 474 506
Male coupler connector*	639 072 506	639 079 506									
Cable clamps	530 115 006	530 115 006	530 145 006	530 145 006	530 115 006	530 115 006	530 115 006	530 145 006	530 115 006	530 115 006	530 145 006
Protective cap for panel connector	637 820 006	637 820 006	637 825 006	637 825 006	637 820 006	637 820 006	637 820 006	637 825 006	637 820 006	637 820 006	637 825 006
Protective cap for cable connector	638 820 006	638 820 006	638 825 006	638 825 006	638 820 006	638 820 006	638 820 006	638 825 006	638 820 006	638 820 006	638 825 006
Protective cap for coupler connector	637 820 436	637 820 436	637 825 436	637 825 436	637 820 436	637 820 436	637 820 436	637 825 436	637 820 436	637 820 436	637 825 436
Flat-Gasket for panel connector	536 945 006	536 945 006	536 946 006	536 946 006	536 945 006	536 945 006	536 945 006	536 946 006	536 945 006	536 945 006	536 946 006
L (sachet de 10)											

Crimp tool with positioner 579 481 006

Tool for insertion and removing contact ø 1 mm 597 104 006, ø 1,6 mm 577 454 006, ø 2,4 mm 577 458 006

Female panel connectors – Male cable connectors – Female coupler connectors

Square female panel connector	637 112 506	637 119 506	637 127 506	637 137 506							637 504 506
Male cable connector*	638 172 506	638 179 506	638 187 506	638 197 506			638 717 506				638 574 506
Female coupler connector*	639 172 506										
Cable clamps	530 115 006	530 115 006	530 145 006	530 145 006	530 115 006	530 115 006	530 115 006	530 145 006	530 115 006	530 115 006	530 145 006
Protective cap for panel connector	637 820 006	637 820 006	637 825 006	637 825 006	637 820 006	637 820 006	637 820 006	637 825 006	637 820 006	637 820 006	637 825 006
Protective cap for cable connector	638 820 006	638 820 006	638 825 006	638 825 006	638 820 006	638 820 006	638 820 006	638 825 006	638 820 006	638 820 006	638 825 006
Protective cap for coupler connector	637 820 436	637 820 436	637 825 436	637 825 436	637 820 436	637 820 436	637 820 436	637 825 436	637 820 436	637 820 436	637 825 436
Flat-Gasket for panel connector	536 945 006	536 945 006	536 946 006	536 946 006	536 945 006	536 945 006	536 945 006	536 946 006	536 945 006	536 945 006	536 946 006
L (sachet de 10)											

Crimp tool with positioner 579 481 006

Tool for insertion and removing contact ø 1 mm 597 104 006, ø 1,6 mm 577 454 006, ø 2,4 mm 577 458 006

- The panel connector is sold with a flat-gasket for the panel connector, 4 screws, 4 nuts and 4 washers.
- Female contact No. 1, which makes the electrical connection before the other contacts and disconnects it after their separation, can be used as a ground contact.
- **Contact No. 1** is connected by a green/yellow wire to the barrel of the cable connector, the panel connector and the coupler connector, removable contact used as a ground contact.
- **Important:** All the contacts must be mounted in the insert using our tool.
- For assembly, wiring, panel connector installation and contact arrangement instructions, see: Technical guides;
- Other accessories, see: Accessories.
- All connectors are delivered with their contacts.
- Thermocouple contacts can be fitted. See: Accessories.
- * Please choose other accessoires one size taller as the corresponding connectors and coupler connectors.

Technical Data

RoHS

Panel connector, cable connector and coupler connector

Panel connector



Cable connector



Coupler connector



Panel connector, cable connector and coupler connector	rectangular housing									
Locking	screw connection									
Protection	IP 65 with flat-gasket for panel connector (supplied with the panel connector)									
Contacts	17 contacts: 13 contacts \varnothing 1 mm and 4 contacts \varnothing 2,4 mm, crimp or solder removable contacts									
Max. current	7 A \varnothing 1 mm – 30 A \varnothing 2,4 mm									
Mechanical endurance	1000 locking and mating cycles									
Contact resistance between pin and socket	< 0,0020 Ω \varnothing 1 mm – < 0,0010 Ω \varnothing 2,4 mm									
Breakdown voltage	at 20 °C, at sea-level: >2500 Volts (RMS)									
Insulation resistance	> 5000 M Ω									
Operating temperature	-40 °C to +100 °C (500 hours at +125 °C)									
Materials	Nickel-plated alloy, gold-plated brass contacts, neoprene insert									
Max. conductor cross-section	<table border="1"> <thead> <tr> <th>Contact</th> <th>\varnothing 1 mm</th> <th>\varnothing 2,4 mm</th> </tr> </thead> <tbody> <tr> <td>Soldered</td> <td>0,6 mm²</td> <td>3,18 mm²</td> </tr> <tr> <td>Crimped*</td> <td>0,6 to 0,93 mm²</td> <td>1,34 to 3,18 mm²</td> </tr> </tbody> </table>	Contact	\varnothing 1 mm	\varnothing 2,4 mm	Soldered	0,6 mm ²	3,18 mm ²	Crimped*	0,6 to 0,93 mm ²	1,34 to 3,18 mm ²
Contact	\varnothing 1 mm	\varnothing 2,4 mm								
Soldered	0,6 mm ²	3,18 mm ²								
Crimped*	0,6 to 0,93 mm ²	1,34 to 3,18 mm ²								

* According to the Number of Contacts

Dimensional Data

Panel connector

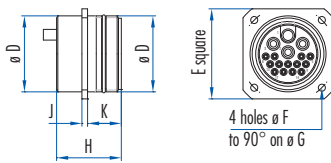

Panel connector and Cable connector

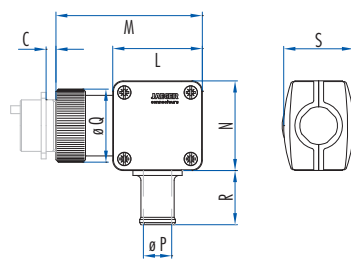

Cable connector and Coupler connector

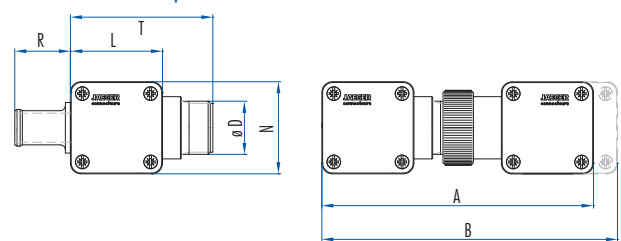

Housing	Assembly		Panel connector – Cable connector – Coupler connector														Cable clamp	
	A	B	C	ø D	E	ø F	ø G	H	J	K	L	M	N	ø Q	S	T	ø P	R
2	123	130	4	M27	32	3,2	34	23	2	12,5	42,6	62,8	47,6	36	31,3	64	depending on the model	30

Part Number

Housing	2
Number of Contacts	17
L ø 1 mm	13
L ø 2,4 mm	4

Male panel connectors – Female cable connectors – Male coupler connectors

Square male panel connector	637 017 506
Female cable connector	638 017 566
Male coupler connector	639 017 566
Cable clamps	530 145 006
Flat-Gasket for panel connector (pack of 10)	536 946 006
Protective cap for panel connector	637 825 006
Protective cap for cable connector	638 825 006
Protective cap for coupler connector	637 825 436
Crimp tool with positioner 579 481 006	
Tool for insertion and removing contacts 1 mm 597 104 206, ø 2,4 mm 577 458 006	

Female panel connectors – Male cable connectors – Female coupler connectors

Square female panel connector	637 117 506
Male cable connector	638 117 566
Female coupler connector	639 117 566
Cable clamps	530 145 006
Flat-Gasket for panel connector (pack of 10)	536 946 006
Protective cap for panel connector	637 825 006
Protective cap for cable connector	638 825 006
Protective cap for coupler connector	637 825 436
Crimp tool with positioner 579 481 006	
Tool for insertion and removing contacts ø 1 mm 597 104 206, ø 2,4 mm 577 458 006	

- The panel connector is sold with a flat-gasket for the panel connector, 4 screws, 4 nuts and 4 washers.
- Female contact No. 1, which makes the electrical connection before the other contacts and disconnects it after their separation, can be used as a ground contact.
Contact No. 1 is connected by a green / yellow wire to the barrel of the cable connector, the panel connector and the coupler connector, removable contact used as a ground contact.
- **Important:** All the contacts must be mounted in the insert using our tool.
- For assembly, wiring, panel connector installation and contact arrangement instructions, see: Technical guides;
- Other accessories, see: Accessories.
- All connectors are delivered with their contacts.

Technical Data

RoHS

Panel connector, cable connector and coupler connector

Panel connector



Cable connector



Coupler connector



Panel connector, cable connector and coupler connector	circular housing						
Locking	screw connection						
Protection	IP 65 with flat-gasket for panel connector						
Contacts	3 and 7 contacts \varnothing 1 mm crimp or solder removable contacts						
Max. current	7A \varnothing 1 mm						
Contact resistance between pin and socket	< 0,0020 Ω						
Breakdown voltage (mated connectors)	> 2500 Volts (RMS)						
Insulation resistance	> 5000 M Ω						
Operating temperature	-40 °C to +85 °C (100 hours at +100 °C)						
Materials	Housing and insert made of POM and PBT, gold-plated brass contacts						
Max. conductor cross-section	<table border="1"> <tr> <td>Contact</td> <td>\varnothing 1 mm</td> </tr> <tr> <td>Soldered</td> <td>0,6 mm²</td> </tr> <tr> <td>Crimped*</td> <td>0,6 to 0,93 mm²</td> </tr> </table> <p>* According to the Number of Contacts</p>	Contact	\varnothing 1 mm	Soldered	0,6 mm ²	Crimped*	0,6 to 0,93 mm ²
Contact	\varnothing 1 mm						
Soldered	0,6 mm ²						
Crimped*	0,6 to 0,93 mm ²						

Dimensional Data

Panel connector

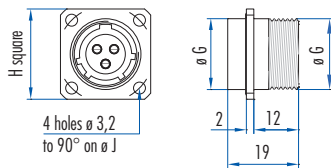

Cable connector

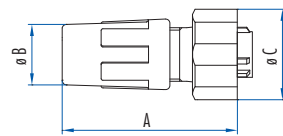

Coupler connector

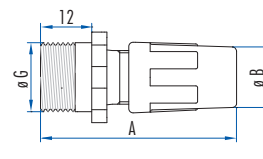

Number of cts	Panel connector			Cable connector and Coupler connector			Weight in grams				Capacity of cable clamp
	\varnothing G	H	\varnothing J	A	\varnothing B	\varnothing C	Male panel connector	Female cable connector	Female panel connector	Male cable connector	Cable connector and male or female Coupler connector
3	16	21	21,5	41	14	21	5	11	5	9	3 to 5 mm
7	19	24	25,7	41	17	24	7	15	8	13	6 to 9 mm

Part Number

Housing	Minex 1	Minex 2
Number of Contacts ø 1 mm	3	7

Male panel connectors – Female cable connectors – Male coupler connectors

Male panel connector	633 203 006	633 207 006
Female cable connector	633 303 006	633 307 006
Male coupler connector	633 253 006	633 257 006
Protective cap for panel connector	633 043 006	633 047 006
Protective cap for cable connector	633 343 006	633 347 006
Flat-Gasket for panel connector (pack of 10)	633 121 006	633 124 006

Complete crimp tool: 579 316 006 (small crimp: ø 1 mm), 579 481 006 (large crimp: ø 1 mm, ø 1,6 mm, ø 2,4 mm)

Tool for insertion and removing contacts 597 104 006

Female panel connectors – Male cable connectors – Female coupler connectors

Female panel connector	633 003 006	633 007 006
Male cable connector	633 103 006	633 107 006
Female coupler connector	633 353 006	633 357 006
Protective cap for panel connector	633 043 006	633 047 006
Protective cap for cable connector	633 343 006	633 347 006
Flat-Gasket for panel connector (pack of 10)	633 121 006	633 124 006

Complete crimp tool: 579 316 006 (small crimp: ø 1 mm), 579 481 006 (large crimp: ø 1 mm, ø 1,6 mm, ø 2,4 mm)

Tool for insertion and removing contacts 597 104 006

- Straight and right-angle panel connectors are also available for printed circuit boards.
- **Important:** All the contacts must be mounted in the insert using our tool.
- For assembly, wiring, panel connector installation and contact arrangement instructions, see: Technical guides;
- Other accessories, see: Accessories.
- All connectors are delivered with their contacts.
- Thermocouple contacts can be fitted. See: Accessories.

Part Number

Panel connector



Atto Miniature Push-Pull Series

Housing	00	0	0	0	1
Number of Contacts \varnothing 0,76 mm	7	8	12	19	27

Male/female, straight/right-angle panel connectors

Straight panel connector	761 107 306	761 108 306	761 112 306	761 119 306	761 127 306
Right-angle panel connector	761 107 456	761 108 456	761 112 456	761 119 456	761 127 456
Straight female panel connector	761 207 306	761 208 306	761 212 306	761 219 306	761 227 306
Right-angle female panel connector	761 207 456	761 208 456	761 212 456	761 219 456	761 227 456

Panel connector

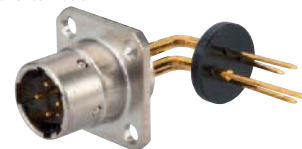

Natto Miniature Push-Pull Series

Housing	00	00	0	1	1	1	1	1	1	1
Number of Contacts	3	4	7	12	19	3	4	7	3	4
L \varnothing 1 mm	3	4	7	12	19					
L \varnothing 1,6 mm						3	4	7		
L \varnothing 2,4 mm									3	4

Male/female, straight/right-angle panel connectors

Straight panel connector	533 233 306	533 801 306	533 273 306	533 283 306	533 293 306	533 310 306	533 350 306	533 390 306	533 430 306	533 470 306
Right-angle panel connector	533 233 456	533 801 456	533 273 456	533 283 456	533 293 456	533 310 456	533 350 456	533 390 456	533 430 456	533 470 456
Straight female panel connector	533 232 306	533 800 306	533 272 306	533 282 306	533 292 306	533 311 306	533 351 306	533 391 306	533 431 306	533 471 306
Right-angle female panel connector	533 232 456	533 800 456	533 272 456	533 282 456	533 292 456	533 311 456	533 351 456	533 391 456	533 431 456	533 471 456

Panel connector



Miniature Series

Housing	1	1	2	2	3
Number of Contacts \varnothing 1 mm	12	19	27	37	55

Male/female, straight/right-angle panel connectors

Straight panel connector	533 503 306	533 514 306	533 513 306	533 525 306	533 523 306
Right-angle panel connector	533 503 456	533 514 456	533 513 456	533 525 456	533 523 456
Straight female panel connector	533 502 306	533 515 306	533 512 306	533 524 306	533 522 306
Right-angle female panel connector	533 502 456	533 515 456	533 512 456	533 524 456	533 522 456

- Solder contacts.

- **technical data:** refer to the technical sheet for each series.

Part Number

Panel connector



Industrial Series

Housing	1	1	1	2	3	3	1	1	2	3
Number of Contacts	3	4	7	12	19	27	3	4	7	27
L \varnothing 1,6 mm	3	4	7	12	19	27				
L \varnothing 2,4 mm							3	4	7	27

Male/female, straight / right-angle panel connectors

Straight male panel connector	630 603 306	630 604 306	630 607 306	630 612 306	630 619 306	630 627 306	630 803 306	630 804 306	630 807 306	630 812 306
Right-angle male panel connector	630 603 456	630 604 456	630 607 456	630 612 456	630 619 456	630 627 456	630 803 456	630 804 456	630 807 456	630 812 456
Straight female panel connector	630 703 306	630 704 306	630 707 306	630 712 306	630 719 306	630 727 306	630 903 306	630 904 306	630 907 306	630 912 306
Right-angle female panel connector	630 703 456	630 704 456	630 707 456	630 712 456	630 719 456	630 727 456	630 903 456	630 904 456	630 907 456	630 912 456

Panel connector



Minex Series

Housing	Minex 1	Minex 2
Number of Contacts \varnothing 1 mm	3	7

Male/female, straight / right-angle panel connectors

Male panel connector	633 203 306	633 207 306
Right-angle male panel connector	633 203 456	633 207 456
Straight female panel connector	633 003 306	633 007 306
Right-angle female panel connector	633 003 456	633 007 456

- Solder contacts.

- **technical data:** refer to the technical sheet for each series.

Technical Data

RoHS

Panel connector, cable connector
and coupler connector

Locking	circular housing
Protection	screw connection
Contacts	IP 50 to IP 54 with conexil in the housing and flat-gasket for panel connector (delivered with the panel connector)
Max. current	1 removable crimp contact \varnothing 12 mm 300 A
Contact resistance between pin and socket	< 0,02 m Ω @ 12 mm
Insulation resistance	> 10000 Volts (RMS)
Breakdown voltage between contact and housing	> 3000 Volts (RMS)
Mechanical endurance	10000 locking and mating cycles
Operating temperature	-40 °C to +100 °C (120 hours at +120 °C)
Salt spray resistance	240 hours
Materials	Light alloy, black anodising, silver-plated brass contacts, polyoxymethylene (POM) insert
Max. cross-section of crimped conductors	95 mm ² cross-section: crimp directly 70 mm ² cross-section: install a reducer (page 172)

Panel connector



Cable connector



Dimensional Data

Panel connector

6 equally spaced holes
 \varnothing 9 on \varnothing 97,5

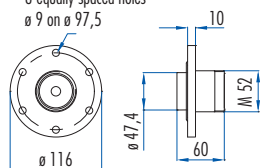

Cable connector

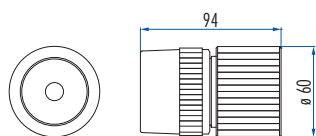

Coupler connector

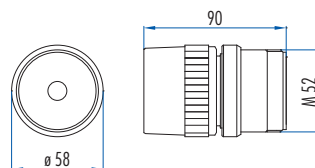

Bulkhead connector

6 equally spaced holes
 \varnothing 9 on \varnothing 97,5

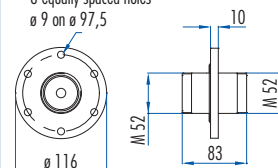

Power Series Puissance – circular 95 mm² single-pole connectors 300 A
Part Number

Housing	5
Number of Contacts ø 12 mm	1

Male panel connectors – Female cable connectors – Male coupler connectors

Circular male panel connector		895 311 206
Female cable connector		895 221 006
Male coupler connector		895 111 006
Cable clamps		D or E see below
Flat-Gasket for panel connector (pack of 10)	round	536 136 006
Protective cap for panel connector		809 306 006
Protective cap for cable connector		809 406 006

Crimp tool: 809 875 006 with crimp jaws 809 912 006 for ø 12 mm

Tool for insertion and removing contacts 896 903 006

Female panel connectors – Male cable connectors – Female coupler connectors

Circular female panel connector		895 321 206
Male cable connector		895 211 006
Female coupler connector		895 121 006
Cable clamps		D or E see below
Flat-Gasket for panel connector (pack of 10)	round	536 136 006
Protective cap for panel connector		809 306 006
Protective cap for cable connector		809 406 006
Male / female bulkhead connector		895 301 206

Crimp tool: 809 875 006 with crimp jaws 809 912 006 for ø 12 mm

Tool for insertion and removing contacts 896 903 006

Part numbers and dimensions of cable clamps:

Circular housing

- D: 809 605 006: ø 20 to ø 32 mm

- E: 809 625 006: ø 20 to ø 25 mm

- Panel connectors are delivered with their O-ring.

- For 95 mm² contacts, if a cable with a smaller cross-section is used, a reducer, delivered with the cable connector, must be used.

- **Important:** The contact must be mounted in the insert using our tool.

- For assembly, wiring, panel connector installation and contact arrangement instructions, see: Technical guides;

- Other accessories, see: Accessories.

- All connectors are delivered with their contact.

Technical Data

RoHS

Panel connector, cable connector
and coupler connector

Locking	screw connection
Protection	IP 50, IP 54 with conexil in the housing and flat-gasket for panel connector (delivered with the panel connector)
Contacts	1 removable crimp contact \varnothing 8 mm
Max. current	175 A
Contact resistance between pin and socket	< 0,03 m Ω \varnothing 8 mm
Insulation resistance	> 10000 M Ω
Breakdown voltage between contact and housing	> 3000 Volts (RMS)
Mechanical endurance	10000 locking and mating cycles
Operating temperature	-40 °C to +100 °C (120 hours at +120 °C)
Salt spray resistance	240 hours
Materials	Light alloy, black anodising, silver-plated brass contacts, polyoxymethylene (POM) insert
Max. cross-section of crimped conductors	35 mm ² cross-section: crimp directly

Panel connector



Cable connector



rectangular housing

Dimensional Data

Panel connector

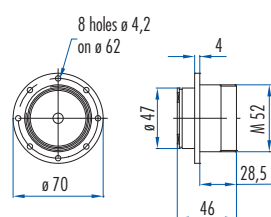

Cable connector

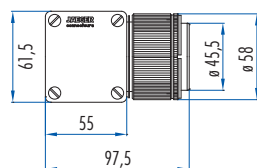

Part Number

Housing	5
Number of Contacts ø 8 mm	1
Female panel connectors – Male cable connectors – Female coupler connectors	
Circular female panel connector	801 141 356
Male cable connector	802 201 356
Cable clamps	A or B or C see below
Flat-Gasket for panel connector (pack of 10)	round 536 136 006
Protective cap for panel connector	809 306 006
Protective cap for cable connector	809 406 006

Crimp tool: 809 835 006 with crimp jaws 809 909 006 for ø 8 mm

Tool for insertion and removing contacts 806 903 006

Part numbers and dimensions of cable clamps:

Rectangular housing

- A: 839 603 006: ø 15 to ø 20 mm
- B: 839 604 006: ø 15 to ø 23 mm
- C: 839 605 006: ø 15 to ø 28 mm

- The panel connector is delivered with a flat-gasket for the panel connector, 4 screws, 4 washers and 4 nuts.
- For 35 mm² contacts, we recommend a class 6 extra-flexible cable. If you wish to use a class 5 flexible cable, a reducer must be added.
- **Important:** The contact must be mounted in the insert using our tool.
- For assembly, wiring, panel connector installation and contact arrangement instructions, see: Technical guides;
- Other accessories, see: Accessories.
- All connectors are delivered with their contact.

Technical Data

RoHS

Panel connector, cable connector
and coupler connector

Locking

Protection

Contacts

Max. current

Contact resistance between pin and socket

Insulation resistance

Breakdown voltage between contact and housing

Mechanical endurance

Operating temperature

Salt spray resistance

Materials

Max. cross-section of crimped conductors

Connection safety

Panel connector



Cable connector



circular housing

screw connection

IP 65 with flat-gasket for panel connector

3 contacts \varnothing 8 mm (2 phases + ground) and 2 removable crimp pilot contacts \varnothing 1,6 mm

175 A

< 0,03 m Ω \varnothing 8 mm

> 10000 M Ω

> 3000 Volts (RMS)

10000 locking and mating cycles

-40 °C to +100 °C (120 hours at +120 °C)

240 hours

Light alloy, black anodising, silver-plated brass contacts \varnothing 8 mm,
gold-plated brass contacts \varnothing 1,6 mm, polyoxymethylene (POM) insert

35 mm² cross-section: crimp directly

2 pilot contacts \varnothing 1,6 mm

Dimensional Data

Square panel connector

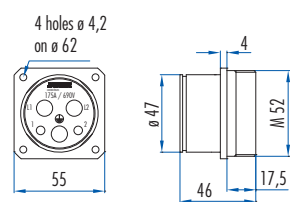

Circular panel connector

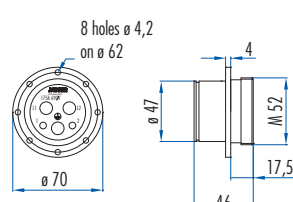

Cable connector

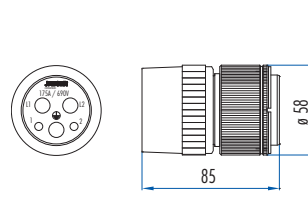

Coupler connector

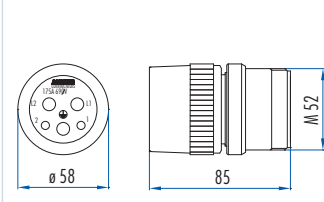

Part Number

Housing	5
Number of Contacts	5
L ø 8 mm	3
L ø 1,6 mm	2

Male panel connectors – Female cable connectors – Male coupler connectors

Circular male panel connector	801 105 356
Square male panel connector	801 115 356
Female cable connector	832 203 356
Male coupler connector	833 103 356
Cable clamps	D or E see below
Flat-Gasket for panel connector (pack of 10)	round 536 136 006 square 536 136 016
Protective cap for panel connector	809 306 006
Protective cap for cable connector	809 406 006

Crimp tool: 809 835 006 with crimp jaws 809 909 006 for ø 8 mm, 579 481 006 crimp tool with positioner for ø 1,6 mm
 Tool for insertion and removing contacts 806 903 006

Female panel connectors – Male cable connectors – Female coupler connectors

Circular female panel connector	801 205 356
Square female panel connector	801 125 356
Male cable connector	832 103 356
Female coupler connector	833 203 356
Cable clamps	D or E see below
Flat-Gasket for panel connector (pack of 10)	round 536 136 006 square 536 136 016
Protective cap for panel connector	809 306 006
Protective cap for cable connector	809 406 006

Crimp tool: 809 835 006 with crimp jaws 809 909 006 for ø 8 mm, 579 481 006 crimp tool with positioner for ø 1,6 mm
 Tool for insertion and removing contacts 806 903 006

Part numbers and dimensions of cable clamps:



Circular housing
 - D: 809 605 006: ø 20 to ø 32 mm
 - E: 809 625 006: ø 20 to ø 25 mm

- The panel connector is delivered with a flat-gasket for the panel connector, 4 screws, 4 washers and 4 nuts.
- For 35 mm² contacts, we recommend a class 6 extra-flexible cable. If you wish to use a class 5 flexible cable, a reducer must be added.
- **Important:** All the contacts must be mounted in the insert using our tool.
- For assembly, wiring, panel connector installation and contact arrangement instructions, see: Technical guides;
- Other accessories, see: Accessories.
- All connectors are delivered with their contacts.

Technical Data

RoHS

Panel connector, cable connector and coupler connector

Panel connector		Rectangular cable connector		Circular cable connector	
Locking	screw connection				
Protection	Depending on the associated cable connector	IP 65 with flat-gasket for panel connector		IP 50 – 54 with conexil in the housing and flat-gasket for panel connector	
Contacts	3 contacts ø 8 mm (2 phases + ground) and 2 removable crimp pilot contacts ø 1,6 mm				
Max. current	175 A				
Contact resistance between pin and socket	< 0,03 mΩ ø 8 mm				
Insulation resistance	> 10000 MΩ				
Breakdown voltage between contact and housing	> 3000 Volts (RMS)				
Mechanical endurance	10000 locking and mating cycles				
Operating temperature	-40 °C to +100 °C (120 hours at +120 °C)				
Salt spray resistance	240 hours				
Materials	Light alloy, black anodising, silver-plated brass contacts ø 8 mm, gold-plated brass contacts ø 16 mm, polyoxymethylene (POM) insert				
Max. cross-section of crimped conductors	25 mm ² cross-section: crimp directly 16 mm ² cross-section: install a reducer (page 172)				
Connection safety	2 pilot contacts ø 1,6 mm				

Dimensional Data

Circular cable connector

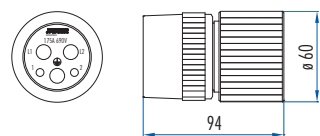

Circular panel connector

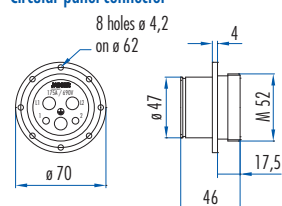

Circular coupler connector

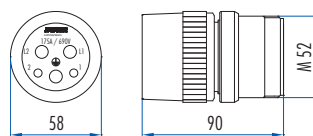

Rectangular cable connector

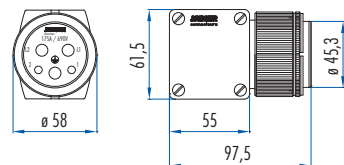

Square rectangular panel connector

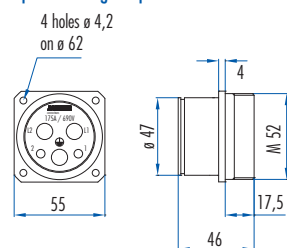

Circular panel connector

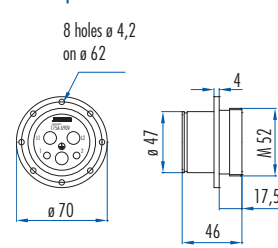

Rectangular coupler connector

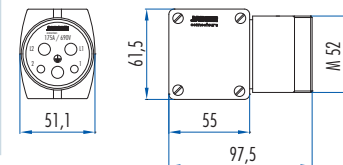

Power Series Puissance – circular and rectangular multi-pole 25 mm² connectors 175 A

Part Number

Housing	5	5
Number of Contacts	5	5
L ø 8 mm	3	3
L ø 1,6 mm	2	2

	rectangular IP 65	circular IP 50 – 54
Male panel connectors – Female cable connectors – Male coupler connectors		
Circular male panel connector	801 105 006	801 145 006
Square male panel connector	801 115 006	
Female cable connector	832 205 006	802 203 006
Male coupler connector	833 105 006	803 103 006
Cable clamps	A or B or C see below	D or E see below
Flat-Gasket for panel connector (pack of 10)	round	536 136 006
	square	536 136 016
Protective cap for panel connector	809 306 006	809 306 006
Protective cap for cable connector	809 406 006	809 406 006

Crimp tool: 809 835 006 with crimp jaws 809 908 006 for ø 8 mm, 579 481 006 crimp tool with positioner for ø 1,6 mm
Tool for insertion and removing contacts 806 903 006

	rectangular IP 65	circular IP 50 – 54
Female panel connectors – Male cable connectors – Female coupler connectors		
Circular female panel connector	801 205 006	801 245 006
Square female panel connector	801 125 006	
Male cable connector	832 105 006	802 103 006
Female coupler connector	833 205 006	803 203 006
Cable clamps	A or B or C see below	D or E see below
Flat-Gasket for panel connector (pack of 10)	round	536 136 006
	square	536 136 016
Protective cap for panel connector	809 306 006	809 306 006
Protective cap for cable connector	809 406 006	809 406 006

Crimp tool: 809 835 006 with crimp jaws 809 908 006 for ø 8 mm, 579 481 006 crimp tool with positioner for ø 1,6 mm
Tool for insertion and removing contacts 806 903 006

Part numbers and dimensions of cable clamps:

Rectangular housing	Circular housing
- A: 839 603 006: ø 15 to ø 20 mm	- D: 809 605 006: ø 20 to ø 32 mm
- B: 839 603 006: ø 15 to ø 23 mm	- D: 809 625 006: ø 20 to ø 25 mm
- C: 839 605 006: ø 15 to ø 28 mm	

- The panel connector is delivered with a flat-gasket for the panel connector, 4 screws, 4 washers and 4 nuts.
- For 35 mm² contacts, we recommend a class 6 extra-flexible cable. If you wish to use a class 5 flexible cable, a reducer must be added.
- **Important:** All the contacts must be mounted in the insert using our tool.
- For assembly, wiring, panel connector installation and contact arrangement instructions, see: Technical guides;
- Other accessories, see: Accessories.
- All connectors are delivered with their contacts.

Technical Data

RoHS

Panel connector, cable connector
and coupler connector

Locking	circular housing
Protection	screw connection
Contacts	IP 50, IP 54 with conexil in the housing and flat-gasket for panel connector (delivered with the panel connector)
Max. current	4 contacts de ø 8 mm 175 A
Contact resistance between pin and socket	< 0,03 mΩ ø 8 mm
Insulation resistance	> 10000 MΩ
Breakdown voltage between contact and housing	> 3000 Volts (RMS)
Mechanical endurance	10000 locking and mating cycles
Operating temperature	-40 °C to +100 °C (120 hours at +120 °C)
Salt spray resistance	240 hours
Materials	Light alloy, black anodising, silver-plated brass contacts, polyoxymethylene (POM) insert
Max. cross-section of crimped conductors	25 mm ² cross-section: crimp directly 16 mm ² cross-section: install a reducer (page 172)

Panel connector



Cable connector



Dimensional Data

Panel connector

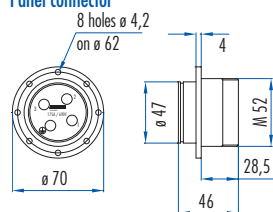

Cable connector

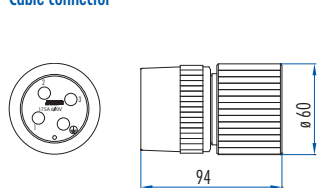

Coupler connector

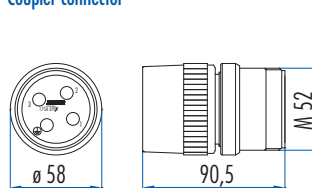

Part Number

Housing	5
Number of Contacts ø 8 mm	4

Male panel connectors – Female cable connectors – Male coupler connectors

Circular male panel connector		841 145 006
Female cable connector		842 203 006
Male coupler connector		843 103 006
Cable clamps		D or E see below
Flat-Gasket for panel connector (pack of 10)	round	536 136 006
Protective cap for panel connector		809 306 006
Protective cap for cable connector		809 406 006

Crimp tool: 809 835 006 with crimp jaws 809 908 006

Tool for insertion and removing contacts 806 903 006

Female panel connectors – Male cable connectors – Female coupler connectors

Circular female panel connector		841 245 006
Male cable connector		842 103 006
Female coupler connector		843 203 006
Cable clamps		D or E see below
Flat-Gasket for panel connector (pack of 10)	round	536 136 006
Protective cap for panel connector		809 306 006
Protective cap for cable connector		809 406 006

Crimp tool: 809 835 006 with crimp jaws 809 908 006

Tool for insertion and removing contacts 806 903 006

Part numbers and dimensions of cable clamps:

Circular housing

- D: 809 605 006: ø 20 to ø 32 mm

- E: 809 625 006: ø 20 to ø 25 mm

- The panel connector is delivered with a flat-gasket for the panel connector, 4 screws, 4 washers and 4 nuts.
- For 25 mm² contacts, if a cable with a smaller cross-section is used, a reducer must be used.
- **Important:** All the contacts must be mounted in the insert using our tool.
- For assembly, wiring, panel connector installation and contact arrangement instructions, see: Technical guides;
- Other accessories, see: Accessories.
- All connectors are delivered with their contacts.

Numerical Index – Connectors with removable contacts

Part No.Series	Designation	Page
633 107 006 .Minex	Male cable connector	82
633 203 006 .Minex	Square male panel connector	82
633 203 306 .Printed Circuits	Male panel connector	84
633 203 456 .Printed Circuits	Male panel connector	84
633 207 006 .Minex	Square male panel connector	82
633 207 306 .Printed Circuits	Male panel connector	84
633 207 456 .Printed Circuits	Male panel connector	84
633 253 006 .Minex	Male coupler connector	82
633 257 006 .Minex	Male coupler connector	82
633 303 006 .Minex	Female cable connector	82
633 307 006 .Minex	Female cable connector	82
633 353 006 .Minex	Female coupler connector	82
633 357 006 .Minex	Female coupler connector	82
633 603 006 .Industrial	Male coupler connector	62
633 603 256 .Industrial High-Performance	Male coupler connector	66
633 604 006 .Industrial	Male coupler connector	62
633 604 256 .Industrial High-Performance	Male coupler connector	66
633 607 006 .Industrial	Male coupler connector	62
633 607 256 .Industrial High-Performance	Male coupler connector	66
633 612 006 .Industrial	Male coupler connector	62
633 612 256 .Industrial High-Performance	Male coupler connector	66
633 619 006 .Industrial	Male coupler connector	62
633 627 006 .Industrial	Male coupler connector	62
633 703 006 .Industrial	Female coupler connector	62
633 703 256 .Industrial High-Performance	Male cable connector	66
633 704 006 .Industrial	Female coupler connector	62
633 704 256 .Industrial High-Performance	Male cable connector	66
633 707 006 .Industrial	Female coupler connector	62
633 707 256 .Industrial High-Performance	Female coupler connector	66
633 712 006 .Industrial	Female coupler connector	62
633 712 256 .Industrial High-Performance	Female coupler connector	66
633 719 006 .Industrial	Female coupler connector	62
633 727 006 .Industrial	Female coupler connector	62
633 803 006 .Industrial	Male coupler connector	62
633 804 006 .Industrial	Male coupler connector	62
633 807 006 .Industrial	Male coupler connector	62
633 812 006 .Industrial	Male coupler connector	62
633 903 006 .Industrial	Female coupler connector	62
633 904 006 .Industrial	Female coupler connector	62
633 907 006 .Industrial	Female coupler connector	62
633 912 006 .Industrial	Female coupler connector	62
637 012 006 .Marine	Square male panel connector	72
637 012 506 .Robotic	Square male panel connector	78
637 017 506 .Robotic with 17 mixed contacts	Square male panel connector	80
637 019 006 .Marine	Square male panel connector	72
637 019 506 .Robotic	Square male panel connector	78
637 027 006 .Marine	Square male panel connector	72
637 027 506 .Robotic	Square male panel connector	78
637 037 006 .Marine	Square male panel connector	72
637 037 506 .Robotic	Square male panel connector	78
637 112 006 .Marine	Square female panel connector	72
637 112 506 .Robotic	Square female panel connector	78
637 117 506 .Robotic with 17 mixed contacts	Square female panel connector	80
637 119 006 .Marine	Square female panel connector	72
637 119 506 .Robotic	Square female panel connector	78
637 127 006 .Marine	Square female panel connector	72
637 127 506 .Robotic	Square female panel connector	78
637 137 006 .Marine	Square female panel connector	72
637 137 506 .Robotic	Square female panel connector	78
637 203 006 .Marine	Square male panel connector	72
637 203 606 .Marine	Male panel connector circular	72
637 204 006 .Marine	Square male panel connector	72
637 204 606 .Marine	Male panel connector circular	72
637 207 006 .Marine	Square male panel connector	72
637 207 606 .Marine	Male panel connector circular	72
637 212 006 .Marine	Square male panel connector	72
637 212 606 .Marine	Male panel connector circular	72
637 303 006 .Marine	Square female panel connector	72

Part No.Series	Designation	Page
637 303 606 .Marine	Female panel connector circular	72
637 304 006 .Marine	Square female panel connector	72
637 304 606 .Marine	Female panel connector circular	72
637 307 006 .Marine	Square female panel connector	72
637 307 606 .Marine	Female panel connector circular	72
637 312 006 .Marine	Square female panel connector	72
637 312 606 .Marine	Female panel connector circular	72
637 403 006 .Marine	Square male panel connector	72
637 404 006 .Marine	Square male panel connector	72
637 404 506 .Robotic	Square male panel connector	78
637 407 006 .Marine	Square male panel connector	72
637 503 006 .Marine	Square female panel connector	72
637 504 006 .Marine	Square female panel connector	72
637 504 506 .Robotic	Square female panel connector	78
637 507 006 .Marine	Square female panel connector	72
637 612 006 .Weatherproof Miniature	Female cable connector	54
637 612 506 .Weatherproof Miniature with ground contact	Female cable connector	58
637 619 006 .Weatherproof Miniature	Female cable connector	54
637 619 506 .Weatherproof Miniature with ground contact	Female cable connector	58
637 627 006 .Weatherproof Miniature	Female cable connector	54
637 627 506 .Weatherproof Miniature with ground contact	Female cable connector	58
637 637 006 .Weatherproof Miniature	Female cable connector	54
637 637 506 .Weatherproof Miniature with ground contact	Female cable connector	58
637 655 006 .Weatherproof Miniature	Female cable connector	54
637 655 506 .Weatherproof Miniature with ground contact	Female cable connector	58
637 662 006 .Weatherproof Miniature	Female coupler connector	54
637 662 506 .Weatherproof Miniature with ground contact	Female coupler connector	58
637 669 006 .Weatherproof Miniature	Female coupler connector	54
637 669 506 .Weatherproof Miniature with ground contact	Female coupler connector	58
637 677 006 .Weatherproof Miniature	Female coupler connector	54
637 677 506 .Weatherproof Miniature with ground contact	Female coupler connector	58
637 687 006 .Weatherproof Miniature	Female coupler connector	54
637 687 506 .Weatherproof Miniature with ground contact	Female coupler connector	58
637 695 006 .Weatherproof Miniature	Female coupler connector	54
637 695 506 .Weatherproof Miniature with ground contact	Female coupler connector	58
637 712 006 .Weatherproof Miniature	Male cable connector	54
637 712 506 .Weatherproof Miniature with ground contact	Male cable connector	58
637 719 006 .Weatherproof Miniature	Male cable connector	54
637 719 506 .Weatherproof Miniature with ground contact	Male cable connector	58
637 727 006 .Weatherproof Miniature	Male cable connector	54
637 727 506 .Weatherproof Miniature with ground contact	Male cable connector	58
637 737 006 .Weatherproof Miniature	Male cable connector	54
637 737 506 .Weatherproof Miniature with ground contact	Male cable connector	58
637 755 006 .Weatherproof Miniature	Male cable connector	54
637 755 506 .Weatherproof Miniature with ground contact	Male cable connector	58
637 762 006 .Weatherproof Miniature	Male coupler connector	54
637 762 506 .Weatherproof Miniature with ground contact	Male coupler connector	58
637 769 006 .Weatherproof Miniature	Male coupler connector	54
637 769 506 .Weatherproof Miniature with ground contact	Male coupler connector	58
637 777 006 .Weatherproof Miniature	Male coupler connector	54
637 777 506 .Weatherproof Miniature with ground contact	Male coupler connector	58
637 787 006 .Weatherproof Miniature	Male coupler connector	54
637 787 506 .Weatherproof Miniature with ground contact	Male coupler connector	58
637 795 006 .Weatherproof Miniature	Male coupler connector	54
637 795 506 .Weatherproof Miniature with ground contact	Male coupler connector	58
638 012 006 .Marine	Female cable connector	72
638 017 566 .Robotic with 17 mixed contacts	Female cable connector	80
638 019 006 .Marine	Female cable connector	72
638 027 006 .Marine	Female cable connector	72
638 037 006 .Marine	Female cable connector	72
638 072 006 .Robotic	Female cable connector	78
638 079 506 .Robotic	Female cable connector	78
638 087 506 .Robotic	Female cable connector	78
638 097 506 .Robotic	Female cable connector	78
638 112 006 .Marine	Male cable connector	72
638 117 566 .Robotic with 17 mixed contacts	Male cable connector	80
638 119 006 .Marine	Male cable connector	72
638 127 006 .Marine	Male cable connector	72

Numerical Index – Connectors with removable contacts

Part No.Series	Designation	Page
681 203 006	Neptunox Female cable connector	74
681 204 006	Neptunox Female cable connector	74
681 207 006	Neptunox Female cable connector	74
681 212 006	Neptunox Female cable connector	74
681 303 006	Neptunox Male cable connector	74
681 304 006	Neptunox Male cable connector	74
681 307 006	Neptunox Male cable connector	74
681 312 006	Neptunox Male cable connector	74
681 403 006	Neptunox Female cable connector	74
681 404 006	Neptunox Female cable connector	74
681 407 006	Neptunox Female cable connector	74
681 503 006	Neptunox Male cable connector	74
681 504 006	Neptunox Male cable connector	74
681 507 006	Neptunox Male cable connector	74
681 607 006	Neptunox Female cable connector	74
681 608 006	Neptunox Female cable connector	74
681 612 006	Neptunox Female cable connector	74
681 619 006	Neptunox Female cable connector	74
681 707 006	Neptunox Male cable connector	74
681 708 006	Neptunox Male cable connector	74
681 712 006	Neptunox Male cable connector	74
681 719 006	Neptunox Male cable connector	74
681 803 006	Neptunox Female cable connector	74
681 804 006	Neptunox Female cable connector	74
681 807 006	Neptunox Female cable connector	74
681 903 006	Neptunox Male cable connector	74
681 904 006	Neptunox Male cable connector	74
681 907 006	Neptunox Male cable connector	74
682 012 006	Neptunox Male coupler connector	74
682 019 006	Neptunox Male coupler connector	74
682 027 006	Neptunox Male coupler connector	74
682 037 006	Neptunox Male coupler connector	74
682 112 006	Neptunox Female coupler connector	74
682 119 006	Neptunox Female coupler connector	74
682 127 006	Neptunox Female coupler connector	74
682 137 006	Neptunox Female coupler connector	74
682 203 006	Neptunox Male coupler connector	74
682 204 006	Neptunox Male coupler connector	74
682 207 006	Neptunox Male coupler connector	74
682 212 006	Neptunox Male coupler connector	74
682 303 006	Neptunox Female coupler connector	74
682 304 006	Neptunox Female coupler connector	74
682 307 006	Neptunox Female coupler connector	74
682 312 006	Neptunox Female coupler connector	74
682 403 006	Neptunox Male coupler connector	74
682 404 006	Neptunox Male coupler connector	74
682 407 006	Neptunox Male coupler connector	74
682 503 006	Neptunox Female coupler connector	74
682 504 006	Neptunox Female coupler connector	74
682 507 006	Neptunox Female coupler connector	74
682 607 006	Neptunox Male coupler connector	74
682 608 006	Neptunox Male coupler connector	74
682 612 006	Neptunox Male coupler connector	74
682 619 006	Neptunox Male coupler connector	74
682 707 006	Neptunox Female coupler connector	74
682 708 006	Neptunox Female coupler connector	74
682 712 006	Neptunox Female coupler connector	74
682 719 006	Neptunox Female coupler connector	74
682 803 006	Neptunox Male coupler connector	74
682 804 006	Neptunox Male coupler connector	74
682 807 006	Neptunox Male coupler connector	74
682 903 006	Neptunox Female coupler connector	74
682 904 006	Neptunox Female coupler connector	74
682 907 006	Neptunox Female coupler connector	74
743 103 006	Puissance Male coupler connector	94
761 107 006	Atto Miniature Push-Pull Square male panel connector	46
761 107 206	Miniature Push-Pull Male panel connector circular	46
761 107 306	Printed Circuits Male panel connector	84

Part No.Series	Designation	Page
761 107 456	Printed Circuits Male panel connector	84
761 108 006	Atto Miniature Push-Pull Square male panel connector	46
761 108 206	Atto Miniature Push-Pull Male panel connector circular	46
761 108 306	Printed Circuits Male panel connector	84
761 108 456	Printed Circuits Male panel connector	84
761 112 006	Atto Miniature Push-Pull Square male panel connector	46
761 112 206	Atto Miniature Push-Pull Male panel connector circular	46
761 112 306	Printed Circuits Male panel connector	84
761 112 456	Printed Circuits Male panel connector	84
761 119 006	Atto Miniature Push-Pull Square male panel connector	46
761 119 206	Atto Miniature Push-Pull Male panel connector circular	46
761 119 306	Printed Circuits Male panel connector	84
761 119 456	Printed Circuits Male panel connector	84
761 127 006	Atto Miniature Push-Pull Square male panel connector	46
761 127 206	Atto Miniature Push-Pull Male panel connector circular	46
761 127 306	Printed Circuits Male panel connector	84
761 127 456	Printed Circuits Male panel connector	84
761 207 006	Atto Miniature Push-Pull Square female panel connector	46
761 207 206	Atto Miniature Push-Pull Female panel connector circular	46
761 207 306	Printed Circuits Female panel connector	84
761 207 456	Printed Circuits Female panel connector	84
761 208 006	Atto Miniature Push-Pull Square female panel connector	46
761 208 206	Atto Miniature Push-Pull Female panel connector circular	46
761 208 306	Printed Circuits Female panel connector	84
761 208 456	Printed Circuits Female panel connector	84
761 212 006	Atto Miniature Push-Pull Square female panel connector	46
761 212 206	Atto Miniature Push-Pull Female panel connector circular	46
761 212 306	Printed Circuits Female panel connector	84
761 212 456	Printed Circuits Female panel connector	84
761 219 006	Atto Miniature Push-Pull Square female panel connector	46
761 219 206	Atto Miniature Push-Pull Female panel connector circular	46
761 219 306	Printed Circuits Female panel connector	84
761 219 456	Printed Circuits Female panel connector	84
761 227 006	Atto Miniature Push-Pull Square female panel connector	46
761 227 206	Atto Miniature Push-Pull Female panel connector circular	84
761 227 306	Printed Circuits Female panel connector	84
761 227 456	Printed Circuits Female panel connector	84
762 107 006	Atto Miniature Push-Pull Male cable connector	46
762 108 006	Atto Miniature Push-Pull Male cable connector	46
762 112 006	Atto Miniature Push-Pull Male cable connector	46
762 119 006	Atto Miniature Push-Pull Male cable connector	46
762 127 006	Atto Miniature Push-Pull Male cable connector	46
762 207 006	Atto Miniature Push-Pull Female cable connector	46
762 208 006	Atto Miniature Push-Pull Female cable connector	46
762 212 006	Atto Miniature Push-Pull Female cable connector	46
762 219 006	Atto Miniature Push-Pull Female cable connector	46
762 227 006	Atto Miniature Push-Pull Female cable connector	46
763 107 006	Atto Miniature Push-Pull Male coupler connector	46
763 108 006	Atto Miniature Push-Pull Male coupler connector	46
763 112 006	Atto Miniature Push-Pull Male coupler connector	46
763 119 006	Atto Miniature Push-Pull Male coupler connector	46
763 127 006	Atto Miniature Push-Pull Male coupler connector	46
763 207 006	Atto Miniature Push-Pull Female coupler connector	46
763 208 006	Atto Miniature Push-Pull Female coupler connector	46
763 212 006	Atto Miniature Push-Pull Female coupler connector	46
763 219 006	Atto Miniature Push-Pull Female coupler connector	46
763 227 006	Atto Miniature Push-Pull Female coupler connector	46
801 105 006	Power Series Puissance Female panel connector circular	92
801 105 356	Power Series Puissance Male panel connector circular	90
801 115 006	Power Series Puissance Square female panel connector	92
801 115 356	Power Series Puissance Square male panel connector	90
801 125 006	Power Series Puissance Square male panel connector	92
801 125 356	Power Series Puissance Square female panel connector	90
801 141 356	Power Series Puissance Female panel connector circular	88
801 145 006	Power Series Puissance Male panel connector circular	92
801 145 006	Power Series Puissance Male panel connector circular	94
801 205 006	Power Series Puissance Male panel connector circular	92
801 205 356	Power Series Puissance Female panel connector circular	90

Numerical Index – Connectors with removable contacts

Part No.Series	Designation	Page
801 245 006 ..Power Series Puissance	Female panel connector circular	92
802 103 006 ..Power Series Puissance	Male cable connector	92
802 201 356 ..Power Series Puissance	Male cable connector	88
802 203 006 ..Power Series Puissance	Male cable connector	92
803 103 006 ..Power Series Puissance	Male coupler connector	92
803 203 006 ..Power Series Puissance	Female coupler connector	92
832 103 356 ..Power Series Puissance	Male cable connector	90
832 105 006 ..Power Series Puissance	Male cable connector	92
832 203 356 ..Power Series Puissance	Female cable connector	90
832 205 006 ..Power Series Puissance	Male cable connector	92
833 105 006 ..Power Series Puissance	Female coupler connector	92
833 205 006 ..Power Series Puissance	Male coupler connector	92

Part No.Series	Designation	Page
841 245 006 ..Power Series Puissance	Female panel connector circular	94
842 103 006 ..Power Series Puissance	Male cable connector	94
842 203 006 ..Power Series Puissance	Female cable connector	94
843 203 006 ..Power Series Puissance	Female coupler connector	94
895 111 006 ..Power Series Puissance	Male coupler connector	86
895 121 006 ..Power Series Puissance	Female coupler connector	86
895 211 006 ..Power Series Puissance	Male cable connector	86
895 221 006 ..Power Series Puissance	Female cable connector	86
895 311 206 ..Power Series Puissance	Male panel connector circular	86
895 321 206 ..Power Series Puissance	Female panel connector circular	86

Accessories

**Cable clamps / Caps / Gaskets and seals / Housings for panel connectors / Screws and nuts /
Ground kit / Couplings / Spare parts / Compound / Sleeves / End fittings /
Threaded adaptors for connectors / Blanking plate kit / Cable glands / Union nuts / Contacts**



Cable clamps



Cable clamp

Cable clamps are used to hold the cable in place and avoid traction on the wire / contacts connections.

Caps

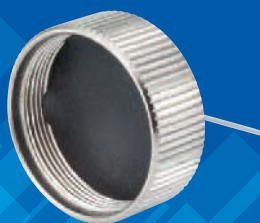

Protective caps for panel-con. Protective caps for coupler connector

Protective caps are designed to prevent foreign substances entering when the cable connector, coupler connector or panel connector are disconnected from each other.

Gaskets and seals



Flat-Gasket for panel connector Cable connector seal

Seals are essential accessories to improve the tightness of our connectors.

Housings for panel connectors



Housing for panel connector Threaded adaptors

The housing is designed to protect the rear of the panel connector. It provides sealing and mechanical protection for the wires and contacts. Some housings provide 360° shielding continuity.

Screws and nuts



Screws and nuts

These screws and nuts are used to attach the panel connectors to the supporting walls.

Grounding kit



Grounding kit for housing

For housings for the Standard, Rapid, Miniature, Industrial and Robotic Series.

Spare parts



Spare parts for circular panel connectors

Couplings



Couplings for bare flexible hoses Couplings for covered flexible hoses

These couplings allow the attachment to one or more outlets of the housing of standardised flexible hoses (according to standards NF C68 100 and NF C68 161).

Sleeves



Sleeves

For B1 to B2 rectangular housings for the Standard, Rapid, Miniature, Industrial and Robotic Series.

End fittings



End fittings for soldering
Pg and ISO threaded end fittings
Crimp end fittings
End fittings for pyrometer tubes

Threaded adaptors for connectors



Threaded adaptors for connectors

For panel connectors in the Standard, Rapid and Weatherproof Series.

Blanking plate kit



Blanking plate kit

Blanking plate kit for the Standard, Rapid, Weatherproof, Miniature, Industrial, Marine, Neptunox and Robotic Series.

Compound



Compound

Compound to coat the connections of all the Series.

Long cable gland



Long cable gland
Short cable gland

Cable glands avoid traction on the wire / contact connections and improve the tightness of the connector.

Union nut



Union nut

Couplings reduce traction on the wire / contact connections and improve the tightness of the connector.

Contacts



Replacement contacts

Our contacts are designed to replace those in our connectors with removable contacts.

Cable clamps for the Standard, Rapid, Miniature, Industrial and Industrial High-Performance Series

To support the cable, **cable connectors** and **coupler connectors** must be fitted with a connection accessory suitable for the diameter of the cable. Cable clamps support the cable and therefore avoid unnecessary and hazardous traction on the wire/contact connections. They are composed of a brass or light alloy barrel and two flanges assembled by two screws locked by toothed washers.

These elements are protected by a nickel or olive-green cadmium coating. The cable clamps are held tightly together between the two shells of the cable connector or coupler connector housing or the housing of the panel connector for rectangular connectors, or are screwed at the rear of the body of the cable connector or coupler connector for circular connectors.

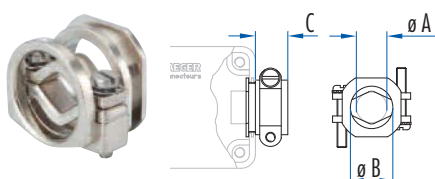

Type 1

Housing	Part Number	Type 1 – Dimensions mm		
		ø A min.	ø B max.	C
1	532 900 006	3	9	8,5
1	532 894 006	7,5	9	11,5
2	532 960 006	7	13	10,2
3-4	532 940 006	12	18	13
5	630 171 006	15	23	14,7

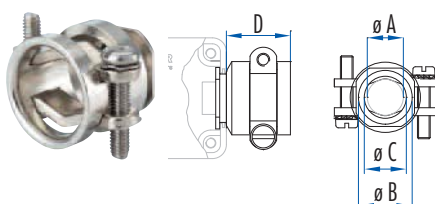

Type 2

Housing	Part Number	Type 2 – Dimensions mm			
		ø A min.	ø B max.	ø C max.	D
1	532 328 006	8,2	13	9	17,1
2	532 329 006	11,8	18	13	20,1
3-4	532 350 006	14,8	23	18	24

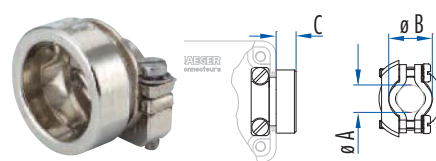

Type 3

Housing	Part Number	Type 3 – Dimensions mm		
		ø A min.	ø B max.	C
1	630 135 006	3	9	5
2	630 138 006	7	13	6
3-4	630 155 006	10	18	7
5	630 175 006	10	23	10

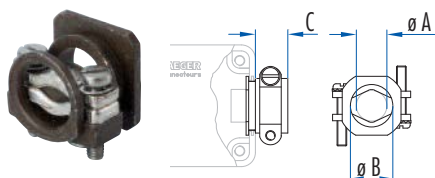

Type 1 High-Performance

Housing	Part Number*	Type 1 – Dimensions mm		
		ø A min.	ø B max.	C
1	532 900 256	3	9	12,3
2	532 960 256	7	13	13

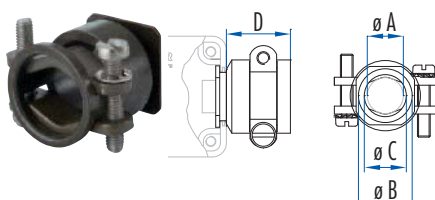

Type 2 High-Performance

Housing	Part Number*	Type 2 – Dimensions mm			
		ø A min.	ø B max.	ø C max.	D
1	532 328 256	8,2	13	9	17,1
2	532 329 256	11,8	18	13	20,1

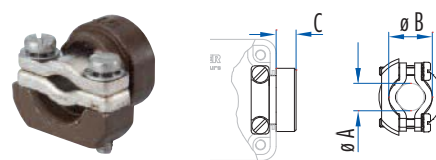

Type 3 High-Performance

Housing	Part Number*	Type 3 – Dimensions mm		
		ø A min.	ø B max.	C
1	630 135 256	3	9	5
2	630 138 256	7	13	6

* olive-green cadmium coating, no RoHS

* olive-green cadmium coating, no RoHS

* olive-green cadmium coating, no RoHS

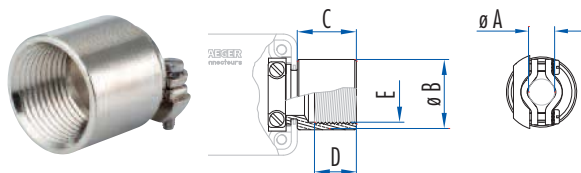

Pg end fitting with cable clamps

Housing	Part Number	Dimensions mm					
		ø A max.	ø A min.	ø B	C	D	E (Pg)
1	536 821 006	9	3	18	18,5	13	9
1	536 822 006	13	7	22	18,5	13	11
3-4	536 823 006	18	10	26	22	17	16

RoHS

Cable clamps for the Weatherproof Series

To support the cable, **cable connectors** and **coupler connectors** must be fitted with a connection accessory suitable for the diameter of the cable. Cable clamps support the cable and therefore avoid unnecessary and hazardous traction on the wire / contact connections. They are composed of a brass or light alloy barrel and two flanges assembled by two screws locked by toothed washers.

These elements are protected by a nickel or olive-green cadmium coating. The cable clamps are screwed at the rear of the body of the cable connector or the coupler connector.

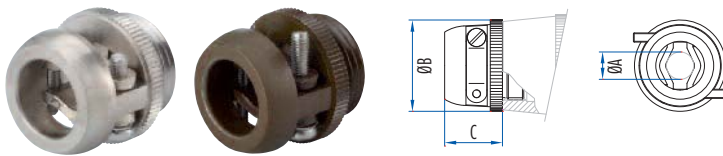

Housing	Nickel-plated	Part Number*	Capacity of the cable clamp		Dimensions mm		
			ø A min.	ø A max.	ø B	C	Pg
1	633 421 006	633 421 256	7,5	12	23	16	11
2	633 422 006	633 422 256	10	17	30	19	16
3	633 423 006	633 423 256	15,5	23	39	28	21
4		633 424 256	15,8	24	48	28	29
5		633 425 256	19	32	56	34	36

* olive-green cadmium coating, no RoHS

RoHS

Cable gland for Neptunox Serie

To support the cable, **cable connectors** and **coupler connectors** must be fitted with a connection accessory suitable for the diameter of the cable. Cable glands support the cable and therefore avoid unnecessary and hazardous traction on the wire / contact connections. They are composed of a brass or light alloy barrel and two flanges assembled by two screws locked by toothed washers.

These elements are protected by a nickel or olive-green cadmium coating. The cable glands are screwed at the rear of the body of the cable connector or the coupler connector.

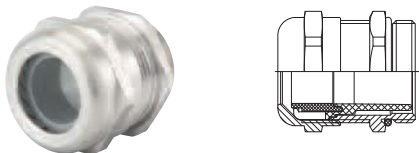

Housing	Part Number	Capacity of the cable clamp		Part Number	Capacity of the cable clamp	
		ø min.	ø max.		ø min.	ø max.
00	680 001 216	2	5	680 001 176	3	6,5
0	680 001 186	3	7	680 001 196	5	10
1	680 001 116	7	12	680 001 126	10	14
2	680 001 136	9	16	680 001 156	13	18

RoHS

Cable clamps for the Miniature Push-Pull Series

To support the cable and ensure it is watertight, **cable connectors** and **coupler connectors** must be fitted with a connection accessory suitable for the diameter of the cable. Cable clamps support the cable and therefore avoid unnecessary and hazardous traction on the wire/contact connections. They are composed of a brass or light alloy barrel and two flanges assembled by two screws locked by toothed

washers. These elements are protected by a nickel coating or black anodising. The cable clamps are screwed at the rear of the body of the cable connector or the coupler connector.

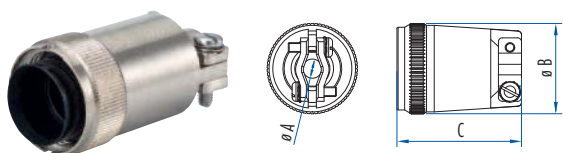

Housing	Part Number	Dimensions mm			
		$\varnothing A$ min.	$\varnothing A$ max.	$\varnothing B$	C
00	769 607 006	3,5	6	14,5	25
0	769 619 006	6	9	17,5	31,5
1	769 627 006	7	10	23,5	32,4
1	769 628 006	5	8,5	23,5	32,4

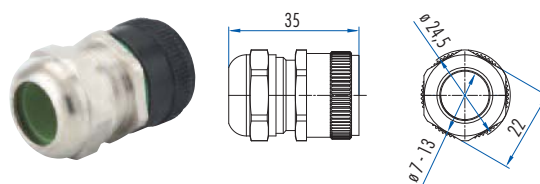

Housing	Part Number
1	769 627 256

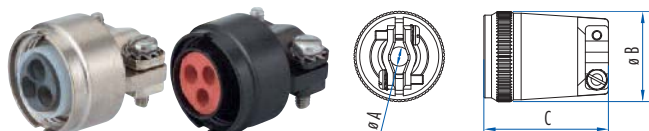

Housing	Contacts	Part Number Standard	Part Number Cable Gland HP	Dimensions mm			
				$\varnothing A$ min.	$\varnothing A$ max.	$\varnothing B$	C
00	3	530 331 006	530 692 006	4,5	6	14	15
00	4	530 841 006	530 844 006	4,5	6	14	15
0	7	530 371 006	530 693 006	5	8,5	18	16

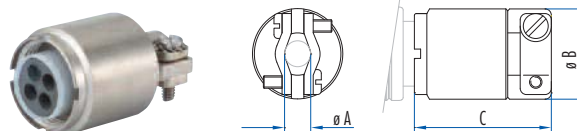

Housing	Contacts	Part Number Long Cable Gland	Dimensions mm			
			$\varnothing A$ min.	$\varnothing A$ max.	$\varnothing B$	C
00	3	530 337 006	4,5	6	14	22
00	4	530 847 006	4,5	6	14	22
0	7	530 377 006	5	8,5	18	23

RoHS

Cable clamps for the Robotic Series

To support the cable, **cable connectors** and **coupler connectors** must be fitted with a connection accessory suitable for the diameter of the cable. Cable clamps support the cable and therefore avoid unnecessary and hazardous traction on the wire / contact connections. They are composed of a brass or light alloy barrel and two flanges assembled by two screws locked by toothed washers.

These elements are protected by a nickel coating. The cable clamps are held tightly together between the two shells of the cable connector or coupler connector housing or the housing of the panel connector.

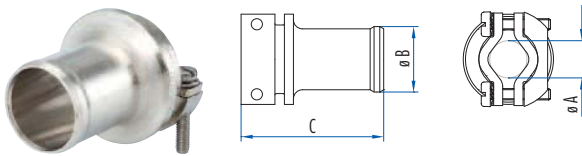

Housing	Part Number	Dimension mm			
		ø A min.	ø A max.	ø B	C
1	530 110 006	2,3	8	11	26,5
1	530 115 006	7	11,5	14,5	31,6
2	530 145 006	10	15,4	18,5	36,7

If you want to adapt this accessory to another series, be careful of the housing:

Robotic Series housing:		Another series housing:
1	=	2
2	=	2

RoHS

Cable clamps for the Power Series Puissance

To support the cable, **cable connectors** and **coupler connectors** must be fitted with a connection accessory suitable for the diameter of the cable. Cable clamps support the cable and therefore avoid unnecessary and hazardous traction on the wire / contact connections. They are composed of a brass or light alloy barrel and two flanges assembled by two screws locked by toothed washers.

These elements are protected by a nickel coating or black anodising. The cable clamps are held tightly together between the two shells of the cable connector or coupler connector housing or the housing of the panel connector for rectangular connectors, or are screwed at the rear of the body of the cable connector or coupler connector for circular connectors.

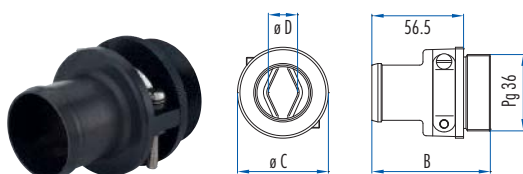

Cable clamp for circular housing

Housing	Part Number	Dimensions mm			
		B	ø C	ø D min.	ø D max.
5	809 605 006	73	56	20	32
5	803 625 006	73	56	20	25

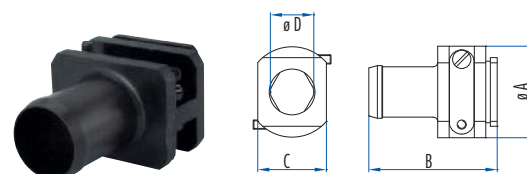

Cable clamp for rectangular housing

Housing	Part Number	Dimensions mm				
		ø A	B	ø C	ø D min.	ø D max.
5	839 603 006	40	56	30	15	20
5	839 604 006	40	56	30	15	23
5	839 605 006	40	56	30	17	28

RoHS

Protective caps for the Standard, Rapid, Weatherproof, Hermetic Series

Protective caps are designed to prevent foreign substances entering and to ensure the contacts in the Weatherproof Series are sealed when the cable connector, coupler connector or panel connector are disconnected from each other.



Protective caps for male / female panel connector – metal

Housing	Standard Series	Rapid Series	Weatherproof Series	Weatherproof HP* Series	Weatherproof Pg outlet Series	Hermetic Series
1	536 910 006	536 910 006	536 910 006	536 910 256	536 910 006	536 910 006
2	536 911 006	536 911 006	536 911 006	536 911 256	536 911 006	536 911 006
3	536 912 006	536 846 006	536 912 006	536 912 256	536 912 006	536 912 006
4	536 913 006		536 913 006	536 913 256		536 913 006
5	536 914 006		536 914 006	539 914 256		536 914 006

* olive-green cadmium coating, no RoHS

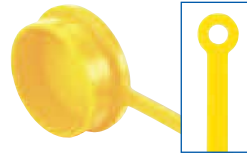

Protective caps for male / female panel connector – plastic

Housing	Standard Series	Rapid Series	Weatherproof Series	Weatherproof HP Series	Weatherproof Pg outlet Series	Hermetic Series
1	536 847 006	536 847 006	536 847 006		536 847 006	536 847 006
2	536 848 006	536 848 006	536 848 006		536 848 006	536 848 006

Does not provide a watertight seal

RoHS

Protective caps for the Standard, Rapid, Weatherproof, Hermetic Series

Protective caps are designed to prevent foreign substances entering and to ensure the contacts in the Weatherproof Series are sealed when the cable connector, coupler connector or panel connector are disconnected from each other.



Standard – Rapid Series

Weatherproof Series, HP (High-Performance), PG outlet

Protective caps for female cable connector – metal

Housing	Standard Series	Rapid Series	Weatherproof Series	Weatherproof HP* Series	Weatherproof Pg outlet Series
1	532 260 006	532 260 006	532 270 006	532 270 256	532 270 006
2	532 278 006	532 278 006	532 271 006	532 271 256	532 271 006
3	532 262 006	532 218 006	532 262 206	532 262 256	532 262 206
4	532 268 006		532 268 206	532 268 256	532 268 206
5	532 269 006		532 269 206	532 269 256	532 269 206

* no RoHS



Standard Series – Rapid

Weatherproof Series, HP (High-Performance), PG outlet

Protective caps for male cable connector – metal

Housing	Standard Series	Rapid Series	Weatherproof Series	Weatherproof HP* Series	Weatherproof Pg outlet Series
1	532 265 006	532 265 006	532 280 006	532 280 256	532 280 006
2	532 279 006	532 279 006	532 281 006	532 281 256	532 281 006
3	532 262 006	532 218 006	532 262 206	532 262 256	532 262 206
4	532 268 006		532 268 206	532 268 256	532 268 206
5	532 269 006		532 269 206	532 269 256	532 269 206

* no RoHS

RoHS

Protective caps for the Standard, Rapid, Weatherproof Series

Protective caps are designed to prevent foreign substances entering and to ensure the contacts in the Weatherproof Series are sealed when the cable connector, coupler connector or panel connector are disconnected from each other.

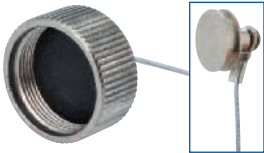

Protective caps for male / female – metal coupler connector

Housing	Standard – Rapid Series
1	536 910 606

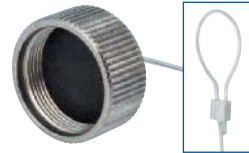

Protective caps for male / female – metal coupler connector

Housing	Weatherproof – Weatherproof Pg outlet Series
1	536 910 756

RoHS

Protective caps for Miniature, Industrial, Weatherproof Miniature, Industrial Weatherproof and Industrial High-Performance Series

Protective caps are designed to prevent foreign substances entering and to ensure the contacts in the Weatherproof Series are sealed when the cable connector, coupler connector or panel connector are disconnected from each other.

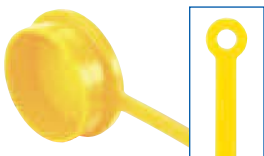

Protective caps for male / female – plastic panel connector

Series: Miniature, Weatherproof Miniature, Industrial, Industrial Weatherproof

Housing	Part Number
1	536 847 006
2	536 848 006
3	



Protective caps for male / female – metal panel connector

Series: Miniature, Weatherproof Miniature, Industrial, Industrial Weatherproof

Housing	Part Number
1	630 720 006
2	536 845 006
3	536 846 006

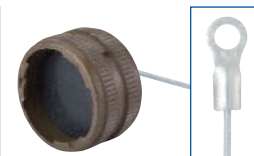

Protective caps for male / female – metal panel connector

Series: Industrial High-Performance*

Housing	Part Number
1	630 720 256
2	536 845 256
3	536 846 256

* no RoHS

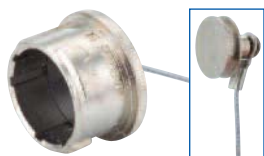

Protective caps for male / female – nickel plated metal cable connector

Series: Miniature, Industrial

Housing	Part Number Keying A	Part Number Keying B
1	632 720 006	632 720 036
2	532 214 006	532 214 036
3	532 218 006	532 218 036

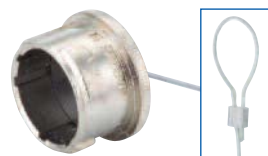

Protective caps for male / female – nickel plated metal cable connector

Series: Weatherproof Miniature, Industrial Weatherproof

Housing	Part Number Keying A	Part Number Keying B
1	632 725 006	632 725 036
2	632 726 006	
3	632 728 006	

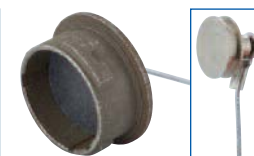

Protective caps for male / female – metal cable connector

Series: Industrial High-Performance*

Housing	Part Number Standard
1	632 720 256

* no RoHS

RoHS

Protective caps for the Miniature, Industrial, Weatherproof Miniature and Industrial Weatherproof

Protective caps are designed to prevent foreign substances entering and to ensure the contacts in the Weatherproof Series are sealed when the cable connector, coupler connector or panel connector are disconnected from each other.

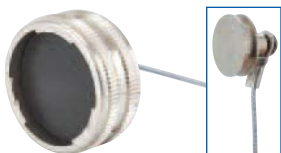

Protective caps for male / female – metal coupler connector

Series: Miniature, Industrial

Housing	Part Number
1	533 620 006
2	533 660 006

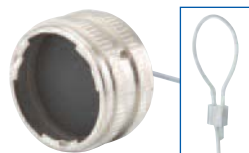

Protective caps for male / female – metal coupler connector

Series: Weatherproof Miniature, Industrial Weatherproof

Housing	Part Number
1	632 771 006
2	632 772 006
3	632 773 006

RoHS

Protective caps for Atto and Natto Miniature Push-Pull Series

Protective caps are designed to prevent foreign substances entering and to ensure the contacts in the Weatherproof Series are sealed when the cable connector, coupler connector or panel connector are disconnected from each other.

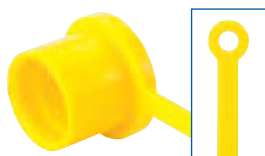

Protective caps for male / female panel connector

Plastic

Housing	Part Number
00	533 329 006
0	533 369 006

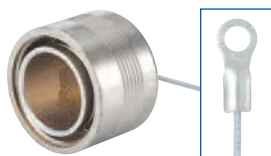

Protective caps for male / female panel connector

Nickel plated metal

Housing	Part Number
00	533 610 006
0	533 650 006
1	761 907 006



Protective caps for male / female panel connector

Metal, black anodising

Housing	Part Number
00	533 610 106
0	533 650 106
1	761 907 106

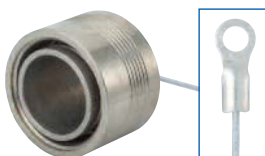

Protective caps for male / female panel connector

ARCAP (stainless steel)

Housing	Part Number
1	761 907 756

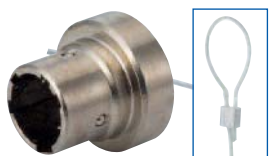

Protective caps for male / female cable connector

Nickel plated metal

Housing	Part Number
00	536 620 006
0	536 660 006
1	536 610 006



Protective caps for male / female cable connector

Metal, black anodising

Housing	Part Number
00	536 620 106
0	536 660 106
1	536 610 106

RoHS

Protective caps for the Marine and Robotic Series

Protective caps are designed to prevent foreign substances entering and to ensure the contacts in the Marine Series are sealed when the cable connector, coupler connector or panel connector are disconnected from each other.

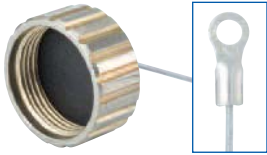

Protective caps for male / female – metal panel connector
ARCAP (stainless steel)

Housing	Part Number
1	637 820 006
2	637 825 006

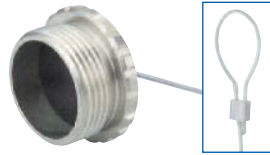

Protective caps for male / female – metal cable connector
ARCAP (stainless steel)

Housing	Part Number
1	638 820 006
2	638 825 006

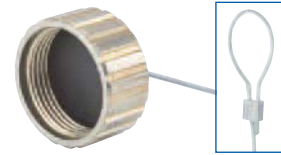

Protective caps for male / female – metal coupler connector
ARCAP (stainless steel)

Housing	Part Number
1	637 820 436
2	637 825 436

RoHS

Protective caps for the Neptunox Series

Protective caps are designed to prevent foreign substances entering and to ensure the contacts are sealed when the cable connector, coupler connector or panel connector are disconnected from each other.

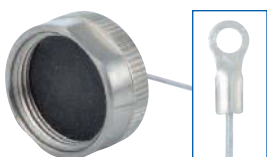

Protective caps for male / female – metal panel connector
INOX 303

Housing	Part Number
00	680 007 006
0	680 007 906
1	680 001 006
2	680 002 006

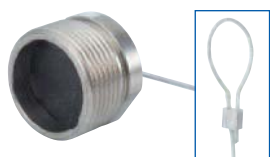

Protective caps for male / female – metal cable connector
INOX 303

Housing	Part Number
00	680 008 006
0	680 008 906
1	680 003 006
2	680 004 006

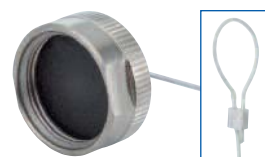

Protective caps for male / female – metal coupler connector
INOX 303

Housing	Part Number
00	680 009 006
0	680 009 906
1	680 005 006
2	680 006 006

RoHS

Protective caps for the Minex Series

Protective caps are designed to prevent foreign substances entering and to ensure the contacts are sealed when the cable connector, coupler connector or panel connector are disconnected from each other.



Protective caps for male / female – plastic panel connector

Number of Cts	Part Number
3	633 043 006
7	633 047 006



Protective caps for male / female – plastic cable connector

Number of Cts	Part Number
3	633 343 006
7	633 347 006

RoHS

Protective caps for the Power Series Puissance

Protective caps are designed to prevent foreign substances entering and to ensure the contacts are sealed when the cable connector, coupler connector or panel connector are disconnected from each other.

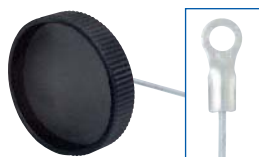

Protective caps for male / female – metal panel connector

Housing	Part Number
5	809 306 006



Protective caps for male / female – metal cable connector

Housing	Part Number
5	809 406 006

RoHS

Gaskets under panel connectors for the Standard, Rapid, Weatherproof, Miniature, Industrial, Marine, Neptunox, Robotic Series

Seals are used to achieve an ingress protection rating of: IP 54/65 depending on the associated cable connector.

Square flat-gasket for panel connector Housings 1-2-3-5

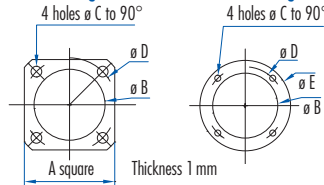

Circular flat-gasket for panel connector Housings 4-5

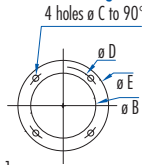

Seal for female cable connector – Standard Series

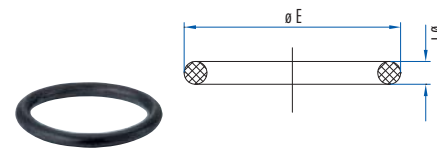

O-ring

Housing	Pack of 10 neoprene gaskets under panel connector	Pack of 10 Viton gaskets under panel connector for cable gland	Dimensions in mm				
			A	ø B	ø C	ø D	ø E
1	536 945 006	536 945 026	27	21,1	3,2	28	
2	536 946 006	536 946 026	32	27,2	3,5	34	
3	536 947 006		43	39,2	4,2	48	
4	536 126 006			45,2	4,2	54	63
5	536 136 006			52,2	4,2	62	70
5	536 136 016		55	48	4,2	62	

Housing	Pack of 10 cable connector seals	Dimensions in mm	
		ø E	ø F
1	532 510 006	19	2
2	532 511 006	25,5	1,8
3	532 512 006	36,5	2,5
4	532 514 006	41	2
5	532 516 006	46	2

RoHS

Gaskets under panel connector for Minex Series

Seals are used to achieve an ingress protection rating of:
IP 54/65 depending on the associated cable connector.



Flat-Gasket for panel connector

Number of Cts	Pack of 10 neoprene gaskets under panel connector
3	633 121 006
7	633 124 006

RoHS

Seals for the Power Series Puissance

Seals are used to achieve an ingress protection rating of:
IP 54/65 depending on the associated cable connector.



Housing	Pack of 10 neoprene gaskets under panel connector	Part Number
5	Circular gaskets under panel connector (neoprene 1 mm)	536 136 006
5	Circular gaskets under panel connector (neoprene 1 mm)	536 136 016

RoHS

Gaskets under panel connector for Atto and Natto Miniature Push-Pull and Neptunox Series

Seals are used to achieve an ingress protection rating of: IP 54/65 depending on the associated cable connector.



Housing	Pack of 10 neoprene gaskets under panel connector	Pack of 10 viton gaskets under panel connector for cable
00	533 328 006	533 328 016
0	533 368 006	533 368 016
1	536 945 006	536 945 016

RoHS

Housings for panel connectors in the Standard and Rapid Series

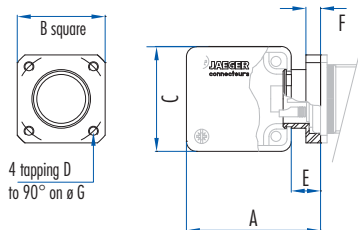

Housing	Number of Contacts	Compleat housing ISO screws	Cable clamp	Accessories		
				10 gaskets under panel connector	pack of 100 ISO screws	End fittings for soldering
1	3-4-6	536 935 006	532 900 006	536 945 006	504 222 006	042 547 006
1	3-4-6	536 935 006	or 532 328 006	536 945 006	504 222 006	or 532 998 006
1	3-4-6	536 935 006	or 630 135 006	536 945 006	504 222 006	or 042 937 006
2	4 (ø4)-8-12	536 937 006	532 960 006	536 946 006	504 222 006	532 955 006
2	4 (ø4)-8-12	536 937 006	or 532 329 006	536 946 006	504 222 006	532 955 006
2	4 (ø4)-8-12	536 937 006	or 630 138 006	536 946 006	504 222 006	532 955 006
3	17	536 996 006	532 940 006	536 947 006	504 266 006	042 940 006
3	17	536 996 006	or 532 350 006	536 947 006	504 266 006	or 042 943 006
3	17	536 996 006	or 630 155 006	536 947 006	504 266 006	
4	25	536 880 006	532 940 006		504 266 006	042 940 006
4	25	536 880 006	or 532 350 006		504 266 006	or 042 943 006
4	25	536 880 006	or 630 155 006		504 266 006	
5	35-52	536 881 006	630 171 006	536 136 016	504 266 006	042 945 006
5	35-52	536 881 006	or 630 175 006	536 136 016	504 266 006	042 945 006

Housing	Dimensions mm						
	A	B	C	ø D	E	F	ø G
1	41	27	32,2	M3	9	5	28
2	45,4	32	36,4	M3	9	5	34
3	52,6	43	47,6	M4	10	6	48
4	58	47	53,8	M4	10	6	54
5	65	54	61,5	M4	10	6	62

RoHS

Threaded adaptors for connectors in the Atto and Natto Miniature Push-Pull Series

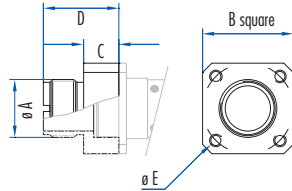

Housing	Part Number Standard	Part Number Cable Gland	Dimensions mm			
			A	B	C	D
00	533 348 006	533 348 106	M 11,5	18	7	15
0	533 349 006	533 349 106	M 15	20	7	15
1	533 347 006	533 347 016	M 20	27	11	19
1	536 866 006	536 866 016	Pg 16	27	10,5	20,5

RoHS

Housings for panel connectors in the Miniature and Industrial Series

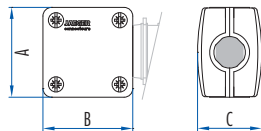

Housing	Housing for panel connector	Cable clamp page 106	Dimension mm			
			A	B	C	
1	533 550 006	532 894 006	1	32,2	32,2	20,2
1	533 550 006	or 532 328 006	2	36,4	36,4	23,5
1	533 550 006	or 630 135 006	3	47,6	42,6	31,3
2	533 558 006	532 960 006				
2	533 558 006	or 532 329 006				
2	533 558 006	or 630 138 006				
3	533 559 006	532 940 006				
3	533 559 006	or 532 350 006				
3	533 559 006	or 630 155 006				

RoHS

Screws and nuts for the Standard, Rapid, Miniature, Industrial, Marine, Neptunox, Robotic Series

These screws and nuts are used to attach the panel connectors to the supporting walls.

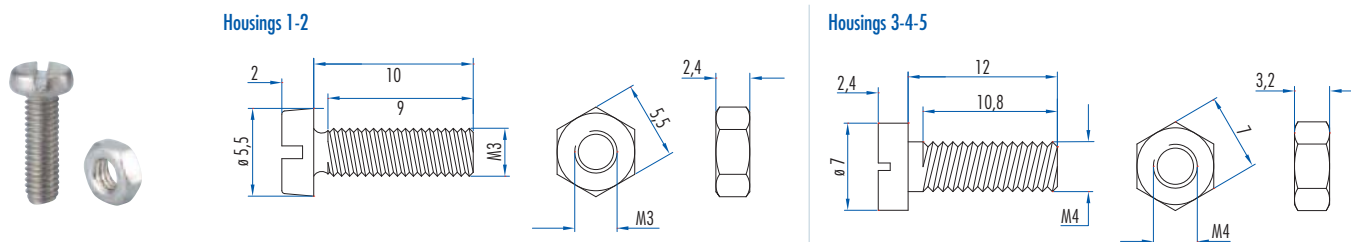

Housing	Screws Pack of 100	Nuts Pack of 100	Thread	Protection
1, 2	504 222 006	504 523 006	M 3	Nickel-plating
3,4,5	504 266 006	504 531 006	M 4	Nickel-plating

RoHS

Grounding kit for housing in the Standard, Rapid, Miniature, Industrial, Robotic Series

For rectangular housings B1 to B5.

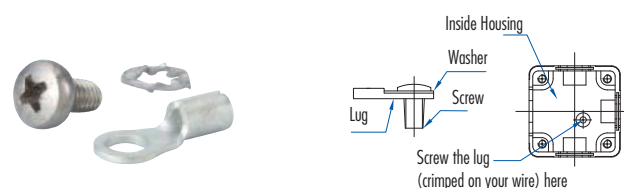

Grounding Kit

630 100 006

RoHS

Couplings for bare flexible hoses in the Standard, Rapid, Miniature, Industrial and Robotic Series

For rectangular housings B1 to B5.

These couplings can be fitted to the **cable connectors** and **coupler connectors** with rectangular housing and housings for panel connectors. They allow the attachment to one or more outlets of the housing of standardised flexible hoses (according to standards NF C68 100 and NF C68 161).

These metal hoses with no sheaths may be simple interlock or semi-weatherproof.

They may also be covered with shielding braid. These couplings consist of a barrel held tightly between the two shells of the cable connector, the coupler connector or the housing for panel connector and a ring with a left-hand thread. The hose is held between the two parts.

A cable clamp is incorporated into the barrel of type two couplings in order to reduce the force exerted on the cable. Barrel and nut are made of nickel-plated brass.

Type 1, couplings without cable clamp

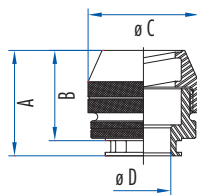

Type 2, couplings with cable clamp

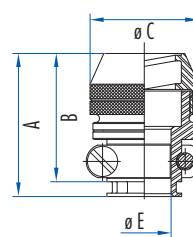

RoHS

Housing	Type 1 couplings without cable clamp	Ø Bare Cable	Type 2 couplings with cable clamp	Clamping Ø		Flexible Hoses	
				min.	max.	Designation	Ø mm
1	532 967 006	9	532 962 006	7	9	MSB 7-7	9,5 x 12,3
2	532 968 006	12	532 963 006	9	12	MSB 7-9	12 x 15
3-4	532 969 006	17	532 964 006	12,5	17	MSB 7-13	17,5 x 20,5
5			532 965 006	12,5	17	MSB 7-13	17,5 x 20,5

Type	Housing	Dimensions in mm				Clamping Ø E		Weight in g
		A	B	Ø C	Ø D	min.	max.	
1	1	16,5	14,5	19	9			15
1	2	18	16	21	12			18
1	3-4-5	22,5	19,5	27	17			34
2	1	22,5	20,5	19		7	9	18
2	2	27	24	21		9	12	28
2	3-4-5	31,5	28,5	27		12,5	17	45

Couplings for covered flexible hoses in the Standard, Rapid, Miniature, Industrial and Robotic Series

For rectangular housings B1 to B5.

These couplings can be fitted to the **cable connectors** and **coupler connectors** with rectangular housing and housings for panel connectors. They allow the attachment to one or more outlets of the housing of standardised flexible hoses (according to standards NF C68 100 and NF C68 161).

These couplings consist of a barrel held tightly between the two shells of the cable connector,

the coupler connector or the housing for panel connector and a ring with a left-hand thread.

The hose is held tightly between the two parts and the plastic sheath is gripped between the two tapered seatings of the ring. A cable clamp is incorporated into the barrel of type 2 couplings in order to reduce the force exerted on the cable.

Barrel and nut are made of nickel-plated brass.

Type 1, couplings without cable clamp

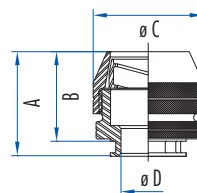

Type 2, couplings with cable clamp

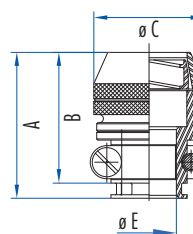

RoHS

Housing	Type 1 couplings without cable clamp	Ø Bare Cable	Type 2 couplings with cable clamp	Clamping Ø		Flexible Hoses	
				min.	max.	Designation	Ø mm
1	530 130 006	9	530 133 006	7	9	MSB 7-7	9 x 12,3
2	530 131 006	11	530 134 006	9	11	MSB 7-9	11 x 15
3-4	530 132 006	15	530 135 006	12,5	15	MSB 7-13	15 x 20,4
5		23		15	23	MSB 7-21	23 x 28,2

Type	Housing	Dimensions in mm				Clamping Ø E		Weight in g
		A	B	Ø C	Ø D	min.	max.	
1	1	16,5	14,5	19	9			15
1	2	18	16	21	11			18
1	3-4	22,5	19,5	27	15			32
1	5	28	24	36	23			60
2	1	22,5	20,5	19		7	9	13
2	2	27	24	21		9	11	25
2	3-4	31,5	28,5	27		12,5	17	45
2	5	44	40	36		15	23	90

Spare parts for circular panel connectors



Housing	Number of Contacts	Pack of 10 gaskets	Nut	Locknut
1	3-4-6	536 440 006	536 446 006	536 443 006
2	4 (ø 4)-8-12	536 441 006	536 447 006	536 444 006
3	17	536 442 006	536 448 006	
4	25	536 451 006	536 450 006	
5	35-52	536 454 006	536 453 006	

RoHS

Sealing accessory: Compound for all series

Compound to coat the connections.

Compound tube
100g
532 080 006

Approximately
1 tube for 10
parts



Type: Silicone elastomer, cold self-curing by contact with water or atmospheric humidity without the addition of a catalyst.

Aim: This product provides protection and weatherproofing for the connections in the connectors, particularly in certain harsh operating conditions:

- very high ambient humidity, splashes of liquid or immersion;
- high ambient temperature;
- severe vibrations

The use of this product is not restricted to electrical connections.

Characteristics after curing:

Mechanical data:

- Tensile force: 35 daN/cm²
- Shore A hardness: 45
- Density at 20 °C: 1,2
- Operating temperature: -70 °C to +200 °C

Electrical data:

Characteristics	Dry sample	Sample after 24 hours immersed in water
Volume resistivity	10 ⁹ MΩ. cm	2 x 10 ⁸ MΩ. cm
Losses (tangent of the angle) for frequency = 1MHz	3 x 10 ⁻³	5 x 10 ⁻³
Electric constant	3 ± 0,2	3 ± 0,2
Dielectric strength	20000 V/mm	18000 V/mm

Resistance to chemical agents:

- (after 8 days of immersion at 25 °C)
- Hot water (85 °C): good resistance
 - Boiling water: significant degradation after one month of immersion.
 - Ethyl alcohol: no swelling

Solvents:

- Acetone: no swelling
- Mineral spirits: significant swelling
- Trichlorethylene: significant swelling
- Fuel: significant swelling
- Kerosene JP4: significant swelling

Oils:

- Oil ASTM N° 1: no swelling
- Oil ASTM N° 3: no swelling

Acids:

- Sulphuric acid 66 °B: no swelling
- Nitric acid 40 °B: no swelling
- Hydrochloric acid 22 °B: no swelling

Bases:

- Sodium hydroxide 36 °B: no swelling
- Ammonia: no swelling

Application:

- Easy and immediate application without prior mixing.
- Curing in the air (7 to 10 hours).
- See instructions with the packaging each tub.

Precautions:

- After use, carefully squeeze out any air remaining in the neck of the tube and replace the cap.
- Avoid storing the tube at temperatures higher than 40 °C.

RoHS

Accessories for sealable connectors for the Standard, Rapid, Miniature, Industrial and Robotic Series

For rectangular housings B1 to B2.



Housing	Pack of screws for panel connector*	Pack of screws for cable connector*	Drilling ϕ for the head of screw	Material
1	536 810 006	536 812 006	1,2 mm	Stainless steel
2	536 810 006	536 813 006	1,2 mm	Stainless steel

* The sealing of a Cable connector / Panel connector assembly requires the use of:
1 pack for panel connector 1 screw + 1 pack for cable connector 2 screws

RoHS

Sleeves for the Standard, Rapid, Miniature, Industrial and Robotic Series

For rectangular housings B1 to B2. Used as a grommet, it protects the connection soldering against the bending forces exerted on the electric cable.

The moulded synthetic rubber sleeve is held between the two shells of the cable connectors, coupler connectors or panel connector housings. It is suitable for cables with insulating sheaths (plastic or rubber). Operating temperature: -25 °C to +100 °C



Housing	Sleeve	Connection cable (mm)	
		ϕ min.	ϕ max.
1	532 970 006	5 *	5,5
2	532 975 006	9 *	10

* N.B. for cables having a diameter less than the minimum value, use an intermediate sleeve (approximately 60 mm in length), e.g. a heat-shrinkable sheath.

RoHS

Weld-on end fittings for the Standard, Rapid, Miniature, Industrial and Robotic Series

For rectangular housings B1 to B5.

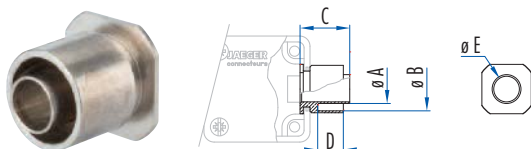

Housing	Part Number	Dimension and No. of the sheath	Dimensions mm					Weight in grams
			ø A	ø B	C	D	ø E	
1	042 937 006	7,5 x 10,5 mm - No. 5	7,5	10,8	15	9,9	6,4	7
1	042 547 006	10,5 x 14 mm - No. 7	10,4	14,9	15	11,3	9,2	7
1	532 998 006*	9,5 x 12,5 mm - MSB 7	9	12,9	15,5	10,4	8	4
2	532 955 006*	12 x 15,2 mm - MSB 9	12	16,5	15	9,7	10,8	5
3-4	042 940 006	15 x 19 mm - No. 11	15	20,1	21,5	17	13,9	11
3-4	042 943 006	19 x 23 mm - No. 16	18,8	24,1	19,5	15	17	18
5	042 945 006*	19 x 23 mm - No. 16	18,7	24,2	19,4	14,9	17	

*These end fittings are designed to be connected to AFNOR standardised flexible metal hose according to standards NFC 68 100 and NFC 68 161.

These end fittings allow the attachment to one or more of the housing outlets of a flexible protective sheath or a braided metal sheath for shielded cables or a grounding braid.

The end fitting is held tightly between the two shells of the cable connector, the coupler connector or the housing of the panel connector.

RoHS

End fittings with Pg and ISO thread* for the Standard, Rapid, Miniature, Industrial, Robotic Series

For rectangular housings B1 to B5.

Type 1, without cable clamp

Type 2, with cable clamp

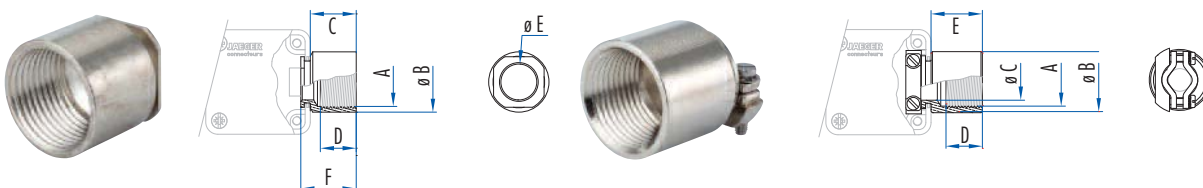

Housing	End fitting Type 1	End fitting + Cable clamp Type 2	Dimensions mm					
			A Thread	ø B	C max.	D	ø E	F
1	536 801 006	536 821 006	Pg 9	18	9	12,5	17,2	20
1	536 806 006		M 13	17	9	9	13,5	16,5
1	536 807 006		M 16	20	9	13	17,2	20
2	536 802 006	536 822 006	Pg 11	22	12,5	13	18,1	21
2	536 808 006		M 20	25	12,5	13	18,1	21
3-4	536 803 006	536 823 006	Pg 16	26	18	16,5	20,8	24
5	630 174 006		Pg 21	34	22	16,5	20,8	24

*According to standards DIN 40430 and NFC 63021

The threaded end fitting is held between the two shells of the cable connector, the coupler connector or the panel connector housing. The end fitting with Pg and ISO thread is designed to receive a coupling compatible with a metal or plastic sheath from the manufacturers listed below. Companies selling sheaths and couplings: Capri-Codec, Conducto, Gaudex, Lutzé, Promer-Pma, Rudolph, SE Sterling, Sonolia, S.T.B, Textilver, T.F.T. These end fittings are brass protected by nickel-plating.

RoHS

Crimp end fittings



Housing	Part Number	Cable max. capacity
1	530 099 006	ø 6,1
1	530 102 006	ø 7,9
2	530 122 006	ø 7,9

RoHS

End fittings for pyrometer tubes

For rectangular housing B1

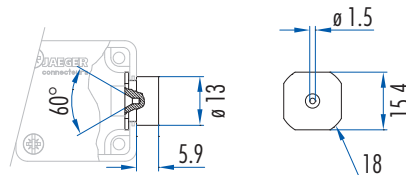

End fitting
for pyrometer tube
530 126 026

RoHS

Threaded adaptors for connectors in the Standard, Rapid, Weatherproof, Miniature, Industrial Series

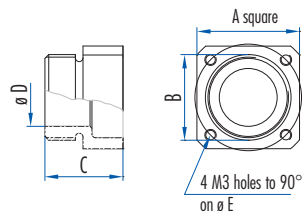

Alternative to panel connector housing

Housing	Support	Thread	Surface Treatment	Material	Dimensions mm				
					A	B	C	ø D	ø E
1	536 864 006*	Pg 13	Ni	Brass	27	Pg 13	12,6	15,2	28
1	536 866 006	Pg 16	Ni	Brass	27	Pg 16	20,5	15,2	28
1	536 863 006	G 1/2"	Ni	Brass	27	G 1/2"	20,5	15,2	28
1	536 861 006	NPT 1/2	Ni	Brass	27	NPT 1/2	20,5	15,2	28

* Only for series Standard, Rapid and Weatherproof.

RoHS

Blanking plate kit for the Standard, Rapid, Weatherproof, Miniature, Industrial, Marine, Neptunox and Robotic Series



This blanking plate kit is designed to seal the hole made in the wall to attach the panel connector when it is no longer needed. After removing the panel connector, fit the seal and then the blanking plate. Then screw in place using 4 screws, nuts and washers.

Material: nickel-plated brass

This blanking plate kit contains: a flat-gasket for panel connector, 4 screws, 4 washers, 4 nuts and a square blanking plate.

Housing	Part Number
1	536 691 066
2	536 692 066

RoHS

Replacement ground terminal \varnothing 1 mm for the Robotic Series



Cable connector	Pack of 10
Coupler Connector	
Male / Female	638 004 016

Cable cross-section: 0,6 mm² to 1,9 mm²

RoHS

Panel connector – cable connector link for the Standard, Rapid, Miniature, Industrial Series



Housing	Part Number
1	532 282 006
2	532 286 006

RoHS

Long cable gland (with claw and/or 360° shield connection) for the Atto and Natto Miniature Push-Pull Series

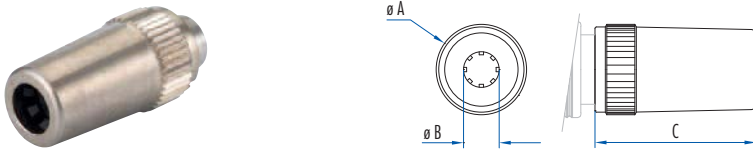

Housing	Standard	360° Shielding	Dimensions mm			
	Part Number	Part Number	ø A	ø B min.	ø B max.	C
00	769 807 006	769 907 006	14	3,6	6,8	25,8
0	769 819 006	769 919 006	17,5	4,6	8,5	31,2
1		769 927 006	22,5	10	13	39,5

RoHS

Short cable gland (without claw) for Atto and Natto Miniature Push-Pull Series



Housing	Standard	360° Shielding	Dimensions mm			
	Part Number	Part Number	ø A	ø B min.	ø B max.	C
00	530 332 006	530 694 006	14	3,6	6,7	18,2
0	530 372 006	530 695 006	17,5	6,3	9	23,8

RoHS

Union nut for the Natto Miniature Push-Pull Series

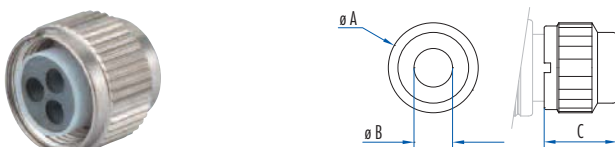

To ensure the cable is watertight and to guarantee the mechanical resistance, cable connectors and coupler connectors must be fitted with a connection accessory to be selected from the following items, according to the diameter of the cable.

Housing	Contacts	Part Number	Dimensions mm		
			ø A	ø B	C
00	3	530 330 006	14	11,3	6
00	4	530 840 006	14	11,3	6
0		530 370 006	17,5	12	7,8

RoHS

Replacement contacts \varnothing 0,76 mm for the Atto Miniature Push-Pull Series

Contacts	Tube of 7 contacts	Tube of 8 contacts	Tube of 12 contacts	Tube of 19 contacts	Tube of 25 contacts	Tube of 27 contacts	Tube of 50 contacts	Tube of 100 contacts	Tube of 200 contacts
Pins	767 107 006	767 108 006	767 012 006	767 119 006	767 025 106	767 127 006	767 050 106	767 100 106	767 200 106
Sockets	767 207 006	767 208 006	767 212 006	767 219 006	767 025 206	767 227 006	767 050 206	767 100 206	767 200 206

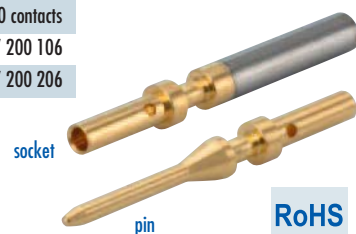

RoHS

Replacement contacts \varnothing 1 mm for the Miniature, Natto Miniature Push-Pull, Marine, Neptunox and Robotic Series

Contacts	Pack of 3 contacts*	Pack of 4 contacts*	Pack of 7 contacts*	Pack of 12 contacts**	Pack of 19 contacts**	Pack of 27 contacts**	Pack of 37 contacts**	Pack of 55 contacts**	Pack of 100 contacts*
Pins	530 303 006	533 877 006	530 307 006	530 311 006	530 313 006	530 315 006	530 317 006	530 319 006	530 211 506
Sockets	530 302 006	533 876 006	530 306 006	530 310 006	530 312 006	530 314 006	530 316 006	530 318 006	530 213 506

* For connectors with 3, 4 and 7 contacts: contact length 14,5 mm

** For connectors with 12, 19, 27, 37 and 55 contacts: contact length 17,5 mm

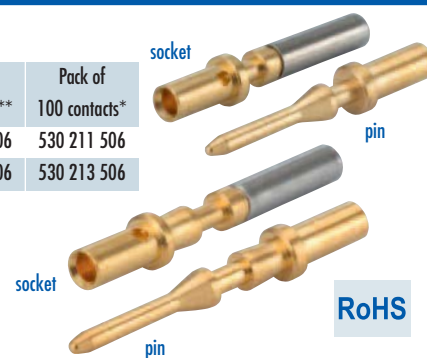

RoHS

Replacement contacts \varnothing 1,6 mm for the Natto Miniature Push-Pull, Industrial, Marine, Neptunox and Robotic Series

Contacts	Pack of 3 contacts	Pack of 7 contacts	Pack of 12 contacts	Pack of 19 contacts	Pack of 27 contacts	Pack of 100 contacts
Pins	630 643 006	630 647 006	630 642 006	630 649 006	630 677 006	630 800 006
Sockets	630 633 006	630 637 006	630 632 006	630 639 006	630 667 006	630 700 006

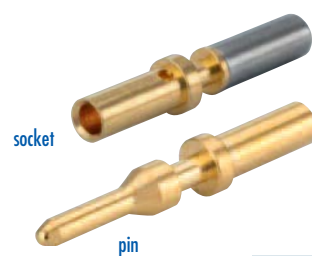

RoHS

Replacement contacts \varnothing 2,4 mm for the Natto Miniature Push-Pull, Industrial, Marine, Neptunox and Robotic Series

Contacts	Pack of 3 contacts	Pack of 4 contacts	Pack of 7 contacts	Pack of 12 contacts
Pins	630 843 006	630 844 006	630 847 006	630 842 006
Sockets	630 833 006	630 834 006	630 837 006	630 832 006

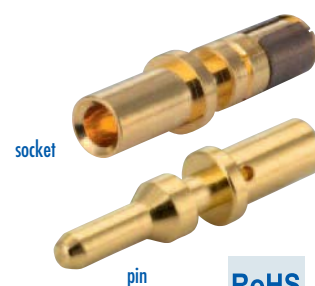

RoHS

Replacement contacts: 17 mixed contacts \varnothing 1 mm and \varnothing 2,4 mm for the Industrial and Robotic Series

Contacts	Tube of 17 contacts	13 contacts \varnothing 1 mm and 3 contacts de \varnothing 2,4 mm
Pins	241 117 006	
Sockets	241 217 006	

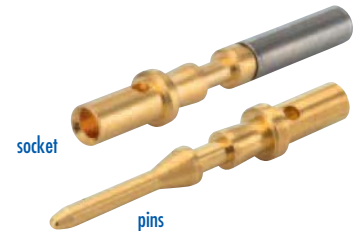

RoHS

Connectors with non-removable contacts

Replacement contacts for the Power Series Puissance

Cross-section of the cable	Contacts		Part Number	
	\varnothing (mm)	No. of contacts per pack	Pins pack	Sockets pack
	1,6	2	630 643 006	630 633 006
25 mm ²	8	3	807 103 006	807 203 006
25 mm ²	8	4	807 104 006	807 204 006
35 mm ²	8	3	807 103 356	807 203 356
95 mm ²	12	2	897 101 106	897 201 006



RoHS

Connectors with removable contacts

Replacement contacts for the Minex Series

Contacts	Pack of 3 contacts	Pack of 7 contacts
Pins	530 303 006	530 307 006
Sockets	530 302 506	530 306 506

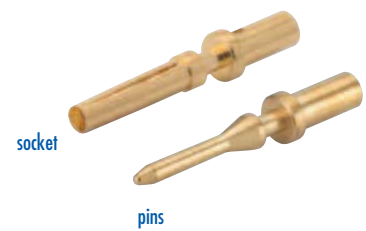

RoHS

Accessories

Technical guides

Thermocouple data

In 1821, Seebeck discovered that an electric current flows in a closed loop with two wires made of different metals if the temperature of one of the two junctions is higher than that of the other. This bimetallic combination was called a **thermocouple**.

If one of the junctions is open whilst keeping its two ends at the same temperature, the electromotive force measured between the two ends depends on the difference in temperature between the two junctions more precisely, the electromotive force depends on the temperature of a single junction if the other is maintained at constant temperature.

Different combinations of metals and alloys were tested to form a thermocouple or thermoelectric couple. The main types of pairs selected are:

- **Type S:** a platinum rhodium 10% component and a platinum component
- **Type J:** an iron component and a constantan component
- **Type T:** a copper component and a constantan component
- **Type K:** a chromel component and an alumel component
- **Type E:** a chromel component and a constantan component

There are other thermocouples but they are less commonly used.

The thermoelectric properties thus discovered gave rise to temperature measurement in industry. Some examples of use: pyrometer tubes, freeze-driers, medical, engine bearing temperature control, etc.

The choice of thermocouple is governed by:

- The temperature range to be measured
- its resistance to pollution and corrosion
- the resistance of the thermocouple for a given gas atmosphere

Type	Colour Code Norme: IEC 584.3	Conductor +	Conductor -	Temperature	Application recommended in atmospheres				
					vacuum	oxidizing	reducing	inert	gaseous
K	Green	Chromel	Alumel	-270 °C +1370 °C		x		x	Air argon
T	Brown	Copper	Constantan	-270 °C +400 °C		x	x		Air argon nitrogen
J	Black	Iron	Constantan	-210 °C +1200 °C	x	x	x	x	Air argon nitrogen
S	Yellow	Platine Rhodium 10% Rh	Platinum	-50 °C +1760 °C		x			Air
E	Purple	Chromel	Constantan	-270 °C +1000 °C		x		x	Air argon

Part Numbers for thermocouple contacts for our Series of connectors with removable contacts

Natto Miniature Push-Pull Series, Miniature Series, Industrial Series, Marine Series, Robotic Series, Minex Series

- These thermocouple contacts, male or female, are interchangeable with the „Standard“ contacts for the series listed above.
- The following are sold in packs under each part number: either two pins or two sockets, each pair of contacts making up a couple.
In each pack, the positive + contact is the shortest pin or socket.

For connector	Couple – Type K		Couple – Type J		Couple – Type T		Couple – Type S		Couple – Type E	
	Chromel + Pack of 2 pins	Alumel - Pack of 2 sockets	Iron + Pack of 2 pins	Constantan - Pack of 2 sockets	Copper + Pack of 2 pins	Constantan - Pack of 2 sockets	Platinum Rhodium 10% + Pack of 2 pins	Platinum - Pack of 2 sockets	Chromel + Pack of 2 pins	Constantan - Pack of 2 sockets
ø 1 mm-B0-B00 3-4-7 cts	530 350 006	530 351 006	530 352 006	530 353 006	530 354 006	530 355 006	530 366 006	530 367 006	503 364 006	530 365 006
ø 1 mm 12-19-27 37-55 contacts	530 356 006	530 357 006	530 358 006	530 359 006	530 360 006	530 361 006	530 368 006	530 369 006	530 308 006	530 309 006
ø 1,6 mm 3-4-7 12-19-27 contacts	630 650 006	630 651 006	630 652 006	630 653 006	630 654 006	630 655 006	630 656 006	630 657 006		



Part No.	Series	Designation	Page
042 547 006	Accessories	End fittings for soldering	122
042 937 006	Accessories	End fittings for soldering	122
042 940 006	Accessories	End fittings for soldering	122
042 943 006	Accessories	End fittings for soldering	122
042 945 006	Accessories	End fittings for soldering	122
241 117 006	Accessories	Pack of replacement contacts	127
241 217 006	Accessories	Pack of replacement contacts	127
503 364 006	Accessories	Thermocouple contact part numbers	128
504 222 006	Accessories	Pack of screws	118
504 266 006	Accessories	Pack of screws	118
504 523 006	Accessories	Pack of screws	118
504 531 006	Accessories	Pack of screws	118
530 099 006	Accessories	Crimp end fittings	123
530 102 006	Accessories	Crimp end fittings	123
530 110 006	Accessories	Cable clamp	109
530 115 006	Accessories	Cable clamp	109
530 122 006	Accessories	Crimp end fittings	123
530 126 026	Accessories	Pyrometer tube end fitting	123
530 130 006	Accessories	Couplings for covered flexible hoses	119
530 131 006	Accessories	Couplings for covered flexible hoses	119
530 132 006	Accessories	Couplings for covered flexible hoses	119
530 133 006	Accessories	Couplings for covered flexible hoses	119
530 134 006	Accessories	Couplings for covered flexible hoses	119
530 135 006	Accessories	Couplings for covered flexible hoses	119
530 145 006	Accessories	Cable clamp	109
530 211 506	Accessories	Pack of replacement contacts	126
530 213 506	Accessories	Pack of replacement contacts	126
530 302 006	Accessories	Pack of replacement contacts	126
530 302 506	Accessories	Pack of replacement contacts	127
530 303 006	Accessories	Pack of replacement contacts	126
530 303 006	Accessories	Pack of replacement contacts	127
530 306 006	Accessories	Pack of replacement contacts	126
530 306 506	Accessories	Pack of replacement contacts	127
530 307 006	Accessories	Pack of replacement contacts	126
530 307 006	Accessories	Pack of replacement contacts	127
530 308 006	Accessories	Thermocouple contact part numbers	128
530 309 006	Accessories	Thermocouple contact part numbers	128
530 310 006	Accessories	Pack of replacement contacts	126
530 311 006	Accessories	Pack of replacement contacts	126
530 312 006	Accessories	Pack of replacement contacts	126
530 313 006	Accessories	Pack of replacement contacts	126
530 314 006	Accessories	Pack of replacement contacts	126
530 315 006	Accessories	Pack of replacement contacts	126
530 316 006	Accessories	Pack of replacement contacts	126
530 317 006	Accessories	Pack of replacement contacts	126
530 318 006	Accessories	Pack of replacement contacts	126
530 319 006	Accessories	Pack of replacement contacts	126
530 330 006	Accessories	Union nut	125
530 331 006	Accessories	Cable clamp	108
530 332 006	Accessories	Short cable gland	125
530 337 006	Accessories	Cable clamp	108
530 350 006	Accessories	Thermocouple contact part numbers	128
530 351 006	Accessories	Thermocouple contact part numbers	128
530 352 006	Accessories	Thermocouple contact part numbers	128
530 353 006	Accessories	Thermocouple contact part numbers	128
530 354 006	Accessories	Thermocouple contact part numbers	128
530 355 006	Accessories	Thermocouple contact part numbers	128
530 356 006	Accessories	Thermocouple contact part numbers	128
530 357 006	Accessories	Thermocouple contact part numbers	128
530 358 006	Accessories	Thermocouple contact part numbers	128
530 359 006	Accessories	Thermocouple contact part numbers	128
530 360 006	Accessories	Thermocouple contact part numbers	128
530 361 006	Accessories	Thermocouple contact part numbers	128
530 365 006	Accessories	Thermocouple contact part numbers	128
530 366 006	Accessories	Thermocouple contact part numbers	128
530 367 006	Accessories	Thermocouple contact part numbers	128
530 368 006	Accessories	Thermocouple contact part numbers	128
530 369 006	Accessories	Thermocouple contact part numbers	128

Part No.	Series	Designation	Page
530 370 006	Accessories	Union nut	125
530 371 006	Accessories	Cable clamp	108
530 372 006	Accessories	Short cable gland	125
530 377 006	Accessories	Cable clamp	108
530 692 006	Accessories	Cable clamp	108
530 693 006	Accessories	Cable clamp	108
530 694 006	Accessories	Short cable gland	125
530 695 006	Accessories	Short cable gland	125
530 840 006	Accessories	Union nut	125
530 841 006	Accessories	Cable clamp	108
530 844 006	Accessories	Cable clamp	108
530 847 006	Accessories	Cable clamp	108
532 080 006	Accessories	Compound	120
532 214 006	Accessories	Protective caps	111
532 214 036	Accessories	Protective caps	111
532 218 006	Accessories	Protective caps	110
532 218 006	Accessories	Protective caps	110
532 218 006	Accessories	Protective caps	111
532 218 036	Accessories	Protective caps	111
532 260 006	Accessories	Protective caps	110
532 260 006	Accessories	Protective caps	110
532 262 006	Accessories	Protective caps	110
532 262 006	Accessories	Protective caps	110
532 262 206	Accessories	Protective caps	110
532 262 206	Accessories	Protective caps	110
532 262 206	Accessories	Protective caps	110
532 262 256	Accessories	Protective caps	110
532 262 256	Accessories	Protective caps	110
532 265 006	Accessories	Protective caps	110
532 265 006	Accessories	Protective caps	110
532 268 006	Accessories	Protective caps	110
532 268 006	Accessories	Protective caps	110
532 268 206	Accessories	Protective caps	110
532 268 206	Accessories	Protective caps	110
532 268 206	Accessories	Protective caps	110
532 268 256	Accessories	Protective caps	110
532 268 256	Accessories	Protective caps	110
532 269 006	Accessories	Protective caps	110
532 269 006	Accessories	Protective caps	110
532 269 206	Accessories	Protective caps	110
532 269 206	Accessories	Protective caps	110
532 269 206	Accessories	Protective caps	110
532 269 256	Accessories	Protective caps	110
532 269 256	Accessories	Protective caps	110
532 270 006	Accessories	Protective caps	110
532 270 006	Accessories	Protective caps	110
532 270 256	Accessories	Protective caps	110
532 271 006	Accessories	Protective caps	110
532 271 006	Accessories	Protective caps	110
532 271 256	Accessories	Protective caps	110
532 278 006	Accessories	Protective caps	110
532 278 006	Accessories	Protective caps	110
532 279 006	Accessories	Protective caps	110
532 279 006	Accessories	Protective caps	110
532 280 006	Accessories	Protective caps	110
532 280 006	Accessories	Protective caps	110
532 280 256	Accessories	Protective caps	110
532 281 006	Accessories	Protective caps	110
532 281 006	Accessories	Protective caps	110
532 281 256	Accessories	Protective caps	110
532 328 006	Accessories	Cable clamp	106
532 328 256	Accessories	Cable clamp	106
532 329 006	Accessories	Cable clamp	106
532 329 256	Accessories	Cable clamp	106
532 350 006	Accessories	Cable clamp	106

Numerical Index – Accessories

Part No.	Series	Designation	Page
532 510 006	Accessories	Seals	115
532 511 006	Accessories	Seals	115
532 512 006	Accessories	Seals	115
532 514 006	Accessories	Seals	115
532 516 006	Accessories	Seals	115
532 894 006	Accessories	Cable clamp	106
532 900 006	Accessories	Cable clamp	106
532 900 256	Accessories	Cable clamp	106
532 940 006	Accessories	Cable clamp	106
532 955 006	Accessories	End fittings for soldering	122
532 960 006	Accessories	Cable clamp	106
532 960 256	Accessories	Cable clamp	106
532 962 006	Accessories	Couplings for bare flexible hoses	119
532 963 006	Accessories	Couplings for bare flexible hoses	119
532 964 006	Accessories	Couplings for bare flexible hoses	119
532 965 006	Accessories	Couplings for bare flexible hoses	119
532 967 006	Accessories	Couplings for bare flexible hoses	119
532 968 006	Accessories	Couplings for bare flexible hoses	119
532 969 006	Accessories	Couplings for bare flexible hoses	119
532 970 006	Accessories	Sleeves	121
532 975 006	Accessories	Sleeves	121
532 998 006	Accessories	End fittings for soldering	122
533 328 006	Accessories	Seals	116
533 328 016	Accessories	Seals	116
533 329 006	Accessories	Protective caps	112
533 347 006	Accessories	Threaded adaptors for connectors	117
533 347 016	Accessories	Threaded adaptors for connectors	117
533 348 006	Accessories	Threaded adaptors for connectors	117
533 348 106	Accessories	Threaded adaptors for connectors	117
533 349 006	Accessories	Threaded adaptors for connectors	117
533 349 106	Accessories	Threaded adaptors for connectors	117
533 368 006	Accessories	Seals	116
533 368 016	Accessories	Seals	116
533 369 006	Accessories	Protective caps	112
533 550 006	Accessories	Housings for panel connectors	117
533 550 006	Accessories	Housings for panel connectors	117
533 550 006	Accessories	Housings for panel connectors	117
533 558 006	Accessories	Housings for panel connectors	117
533 558 006	Accessories	Housings for panel connectors	117
533 558 006	Accessories	Housings for panel connectors	117
533 559 006	Accessories	Housings for panel connectors	117
533 559 006	Accessories	Housings for panel connectors	117
533 559 006	Accessories	Housings for panel connectors	117
533 610 006	Accessories	Protective caps	112
533 610 106	Accessories	Protective caps	112
533 620 006	Accessories	Protective caps	112
533 650 006	Accessories	Protective caps	112
533 650 106	Accessories	Protective caps	112
533 660 006	Accessories	Protective caps	112
533 876 006	Accessories	Pack of replacement contacts	126
533 877 006	Accessories	Pack of replacement contacts	126
536 126 006	Accessories	Seals	115
536 136 006	Accessories	Seals	115
536 136 006	Accessories	Seals	115
536 136 016	Accessories	Seals	115
536 136 016	Accessories	Seals	115
536 440 006	Accessories	Spare parts for circular panel connectors	120
536 441 006	Accessories	Spare parts for circular panel connectors	120
536 442 006	Accessories	Spare parts for circular panel connectors	120
536 443 006	Accessories	Spare parts for circular panel connectors	120
536 444 006	Accessories	Spare parts for circular panel connectors	120
536 446 006	Accessories	Spare parts for circular panel connectors	120
536 447 006	Accessories	Spare parts for circular panel connectors	120
536 448 006	Accessories	Spare parts for circular panel connectors	120
536 450 006	Accessories	Spare parts for circular panel connectors	120
536 451 006	Accessories	Spare parts for circular panel connectors	120
536 453 006	Accessories	Spare parts for circular panel connectors	120
536 454 006	Accessories	Spare parts for circular panel connectors	120

Part No.	Series	Designation	Page
536 610 006	Accessories	Protective caps	112
536 610 106	Accessories	Protective caps	112
536 620 006	Accessories	Protective caps	112
536 620 106	Accessories	Protective caps	112
536 660 006	Accessories	Protective caps	112
536 660 106	Accessories	Protective caps	112
536 691 066	Accessories	Blanking plate kit	124
536 692 066	Accessories	Blanking plate kit	124
536 801 006	Accessories	End fittings with Pg and ISO thread	122
536 802 006	Accessories	End fittings with Pg and ISO thread	122
536 803 006	Accessories	End fittings with Pg and ISO thread	122
536 806 006	Accessories	End fittings with Pg and ISO thread	122
536 807 006	Accessories	End fittings with Pg and ISO thread	122
536 808 006	Accessories	End fittings with Pg and ISO thread	122
536 810 006	Accessories	Accessories for sealable connectors	121
536 810 006	Accessories	Accessories for sealable connectors	121
536 821 006	Accessories	Cable clamp	106
536 821 006	Accessories	End fittings with Pg and ISO thread	122
536 822 006	Accessories	Cable clamp	106
536 822 006	Accessories	End fittings with Pg and ISO thread	122
536 823 006	Accessories	Cable clamp	106
536 823 006	Accessories	End fittings with Pg and ISO thread	122
536 845 006	Accessories	Protective caps	111
536 845 256	Accessories	Protective caps	111
536 846 006	Accessories	Protective caps	110
536 846 006	Accessories	Protective caps	111
536 846 256	Accessories	Protective caps	111
536 847 006	Accessories	Protective caps	110
536 847 006	Accessories	Protective caps	110
536 847 006	Accessories	Protective caps	110
536 847 006	Accessories	Protective caps	110
536 847 006	Accessories	Protective caps	110
536 847 006	Accessories	Protective caps	111
536 847 006	Accessories	Protective caps	110
536 848 006	Accessories	Protective caps	110
536 848 006	Accessories	Protective caps	110
536 848 006	Accessories	Protective caps	110
536 848 006	Accessories	Protective caps	110
536 848 006	Accessories	Protective caps	110
536 848 006	Accessories	Protective caps	111
536 861 006	Accessories	Threaded adaptors for connectors	123
536 863 006	Accessories	Threaded adaptors for connectors	123
536 864 006	Accessories	Threaded adaptors for connectors	123
536 866 006	Accessories	Threaded adaptors for connectors	117
536 866 006	Accessories	Threaded adaptors for connectors	123
536 866 016	Accessories	Threaded adaptors for connectors	117
536 880 006	Accessories	Housings for panel connectors	116
536 880 006	Accessories	Housings for panel connectors	116
536 880 006	Accessories	Housings for panel connectors	116
536 881 006	Accessories	Housings for panel connectors	116
536 881 006	Accessories	Housings for panel connectors	116
536 910 006	Accessories	Protective caps	110
536 910 006	Accessories	Protective caps	110
536 910 006	Accessories	Protective caps	110
536 910 006	Accessories	Protective caps	110
536 910 006	Accessories	Protective caps	110
536 910 256	Accessories	Protective caps	110
536 910 606	Accessories	Protective caps	111
536 910 756	Accessories	Protective caps	111
536 911 006	Accessories	Protective caps	110
536 911 006	Accessories	Protective caps	110
536 911 006	Accessories	Protective caps	110
536 911 006	Accessories	Protective caps	110
536 911 006	Accessories	Protective caps	110
536 911 256	Accessories	Protective caps	110
536 912 006	Accessories	Protective caps	110
536 912 006	Accessories	Protective caps	110
536 912 006	Accessories	Protective caps	110
536 912 006	Accessories	Protective caps	110

Part No.	Series	Designation	Page
536 912 256	Accessories	Protective caps	110
536 913 006	Accessories	Protective caps	110
536 913 006	Accessories	Protective caps	110
536 913 006	Accessories	Protective caps	110
536 913 256	Accessories	Protective caps	110
536 914 006	Accessories	Protective caps	110
536 914 006	Accessories	Protective caps	110
536 914 006	Accessories	Protective caps	110
536 935 006	Accessories	Housings for panel connectors	116
536 935 006	Accessories	Housings for panel connectors	116
536 935 006	Accessories	Housings for panel connectors	116
536 937 006	Accessories	Housings for panel connectors	116
536 937 006	Accessories	Housings for panel connectors	116
536 937 006	Accessories	Housings for panel connectors	116
536 945 006	Accessories	Seals	115
536 945 006	Accessories	Seals	116
536 945 016	Accessories	Seals	116
536 946 006	Accessories	Seals	115
536 947 006	Accessories	Seals	115
536 996 006	Accessories	Housings for panel connectors	116
536 996 006	Accessories	Housings for panel connectors	116
536 996 006	Accessories	Housings for panel connectors	116
539 914 256	Accessories	Protective caps	110
630 100 006	Accessories	Ground kit for housing	118
630 135 006	Accessories	Cable clamp	106
630 135 256	Accessories	Cable clamp	106
630 138 006	Accessories	Cable clamp	106
630 138 256	Accessories	Cable clamp	106
630 155 006	Accessories	Cable clamp	106
630 171 006	Accessories	Cable clamp	106
630 174 006	Accessories	End fittings with Pg and ISO thread	122
630 175 006	Accessories	Cable clamp	106
630 632 006	Accessories	Pack of replacement contacts	126
630 633 006	Accessories	Pack of replacement contacts	126
630 633 006	Accessories	Pack of replacement contacts	127
630 637 006	Accessories	Pack of replacement contacts	126
630 639 006	Accessories	Pack of replacement contacts	126
630 642 006	Accessories	Pack of replacement contacts	126
630 643 006	Accessories	Pack of replacement contacts	126
630 643 006	Accessories	Pack of replacement contacts	126
630 643 006	Accessories	Pack of replacement contacts	127
630 649 006	Accessories	Pack of replacement contacts	126
630 650 006	Accessories	Thermocouple contact part numbers	128
630 651 006	Accessories	Thermocouple contact part numbers	128
630 652 006	Accessories	Thermocouple contact part numbers	128
630 653 006	Accessories	Thermocouple contact part numbers	128
630 654 006	Accessories	Thermocouple contact part numbers	128
630 655 006	Accessories	Thermocouple contact part numbers	128
630 655 006	Accessories	Thermocouple contact part numbers	128
630 657 006	Accessories	Thermocouple contact part numbers	128
630 667 006	Accessories	Pack of replacement contacts	126
630 677 006	Accessories	Pack of replacement contacts	126
630 700 006	Accessories	Pack of replacement contacts	126
630 720 006	Accessories	Protective caps	111
630 720 256	Accessories	Protective caps	111
630 800 006	Accessories	Pack of replacement contacts	126
630 832 006	Accessories	Pack of replacement contacts	126
630 833 006	Accessories	Pack of replacement contacts	126
630 834 006	Accessories	Pack of replacement contacts	126
630 837 006	Accessories	Pack of replacement contacts	126
630 842 006	Accessories	Pack of replacement contacts	126
630 843 006	Accessories	Pack of replacement contacts	126
630 844 006	Accessories	Pack of replacement contacts	126
630 847 006	Accessories	Pack of replacement contacts	126
632 720 006	Accessories	Protective caps	111
632 720 036	Accessories	Protective caps	111
632 720 256	Accessories	Protective caps	111
632 725 006	Accessories	Protective caps	111

Part No.	Series	Designation	Page
632 725 036	Accessories	Protective caps	111
632 725 256	Accessories	Protective caps	111
632 726 006	Accessories	Protective caps	111
632 726 256	Accessories	Protective caps	111
632 728 006	Accessories	Protective caps	111
632 728 256	Accessories	Protective caps	111
632 771 006	Accessories	Protective caps	112
632 772 006	Accessories	Protective caps	112
632 773 006	Accessories	Protective caps	112
633 043 006	Accessories	Protective caps	114
633 047 006	Accessories	Protective caps	114
633 121 006	Accessories	Seals	115
633 124 006	Accessories	Seals	115
633 343 006	Accessories	Protective caps	114
633 347 006	Accessories	Protective caps	114
633 421 006	Accessories	Cable clamp	107
633 421 256	Accessories	Cable clamp	107
633 422 006	Accessories	Cable clamp	107
633 422 256	Accessories	Cable clamp	107
633 423 006	Accessories	Cable clamp	107
633 423 256	Accessories	Cable clamp	107
633 424 256	Accessories	Cable clamp	107
633 425 256	Accessories	Cable clamp	107
637 820 006	Accessories	Protective caps	113
637 820 436	Accessories	Protective caps	113
637 825 006	Accessories	Protective caps	113
637 825 436	Accessories	Protective caps	113
638 004016	Accessories	Replacement ground terminal	124
638 820 006	Accessories	Protective caps	113
638 825 006	Accessories	Protective caps	113
680 001 006	Accessories	Protective caps	113
680 002 006	Accessories	Protective caps	113
680 003 006	Accessories	Protective caps	113
680 004 006	Accessories	Protective caps	113
680 005 006	Accessories	Protective caps	113
680 006 006	Accessories	Protective caps	113
680 007 006	Accessories	Protective caps	113
680 007 906	Accessories	Protective caps	113
680 008 006	Accessories	Protective caps	113
680 008 906	Accessories	Protective caps	113
680 009 006	Accessories	Protective caps	113
680 009 006	Accessories	Protective caps	113
761 907 006	Accessories	Protective caps	112
761 907 106	Accessories	Protective caps	112
761 907 756	Accessories	Protective caps	112
767 012 006	Accessories	Pack of replacement contacts	126
767 025 106	Accessories	Pack of replacement contacts	126
767 025 206	Accessories	Pack of replacement contacts	126
767 050 106	Accessories	Pack of replacement contacts	126
767 050 206	Accessories	Pack of replacement contacts	126
767 100 106	Accessories	Pack of replacement contacts	126
767 100 206	Accessories	Pack of replacement contacts	126
767 107 006	Accessories	Pack of replacement contacts	126
767 108 006	Accessories	Pack of replacement contacts	126
767 119 006	Accessories	Pack of replacement contacts	126
767 127 006	Accessories	Pack of replacement contacts	126
767 200 106	Accessories	Pack of replacement contacts	126
767 200 206	Accessories	Pack of replacement contacts	126
767 207 006	Accessories	Pack of replacement contacts	126
767 208 006	Accessories	Pack of replacement contacts	126
767 212 006	Accessories	Pack of replacement contacts	126
767 219 006	Accessories	Pack of replacement contacts	126
767 227 006	Accessories	Pack of replacement contacts	126
769 607 006	Accessories	Cable clamp	108
769 619 006	Accessories	Cable clamp	108
769 627 006	Accessories	Cable clamp	108
769 627 006	Accessories	Cable clamp	108
769 628 006	Accessories	Cable clamp	108

Part No.	Series	Designation	Page
769 807 006	Accessories	Short cable gland	125
769 819 006	Accessories	Short cable gland	125
769 907 006	Accessories	Short cable gland	125
769 919 006	Accessories	Short cable gland	125
769 927 006	Accessories	Short cable gland	125
803 625 006	Accessories	Cable clamp	109
807 103 006	Accessories	Pack of replacement contacts	127
807 103 356	Accessories	Pack of replacement contacts	127
807 104 006	Accessories	Pack of replacement contacts	127
807 203 006	Accessories	Pack of replacement contacts	127
807 203 356	Accessories	Pack of replacement contacts	127

Part No.	Series	Designation	Page
807 204 006	Accessories	Pack of replacement contacts	127
809 306 006	Accessories	Protective caps	114
809 406 006	Accessories	Protective caps	114
809 605 006	Accessories	Cable clamp	109
839 603 006	Accessories	Cable clamp	109
839 604 006	Accessories	Cable clamp	109
839 605 006	Accessories	Cable clamp	109
897 101 106	Accessories	Pack of replacement contacts	127
897 201 006	Accessories	Pack of replacement contacts	127

Technical guides

Contact arrangement / Assembly / Wiring / Example of cable clamp assembly /
Attachment of panel connectors to a wall / Polarisation



Standard, Rapid, Weatherproof and Hermetic Series

Housing 1

3 contacts
1 x \varnothing 2 mm, 2 x \varnothing 3 mm



Housing 1

4 contacts
4 x \varnothing 2 mm



Housing 1

6 contacts
6 x \varnothing 2 mm



Housing 2

4 contacts
4 x \varnothing 4 mm



Housing 2

8 contacts
6 x \varnothing 2 mm, 2 x \varnothing 3 mm,



Housing 2

12 contacts
12 x \varnothing 2 mm

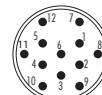

Housing 3

17 contacts
15 x \varnothing 2 mm, 2 x \varnothing 3 mm,

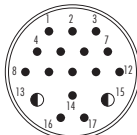
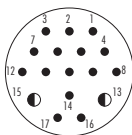

Housing 4

25 contacts
23 x \varnothing 3 mm, 2 x \varnothing 3 mm

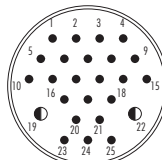
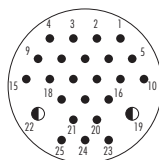

Housing 5

35 contacts
33 x \varnothing 2 mm, 2 x \varnothing 3 mm

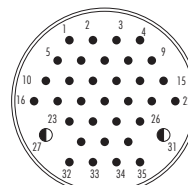
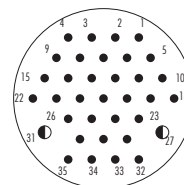

Housing 5

52 contacts
52 x \varnothing 2 mm

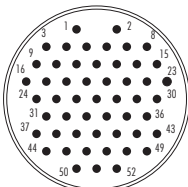
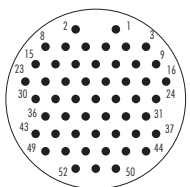

Identification of the contacts on the solder side

○ Male panel connector
Male cable connector

⊙ Female panel connector
Female cable connector

• contact \varnothing 2 mm

● contact \varnothing 3 mm

⊕ contact \varnothing 4 mm

Atto Miniature Push-Pull Serie

Housing 00
7 contacts
7 x ø 0,76 mm

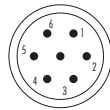

Housing 0
8 contacts
8 x ø 0,76 mm

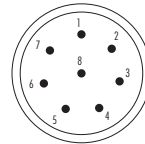
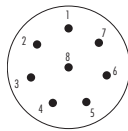

Housing 0
12 contacts
12 x ø 0,76 mm

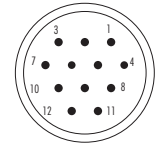
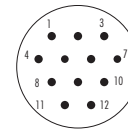

Housing 0
19 contacts
19 x ø 0,76 mm

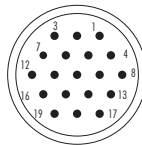
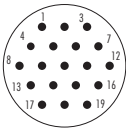

Housing 1
27 contacts
27 x ø 0,76 mm

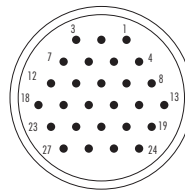
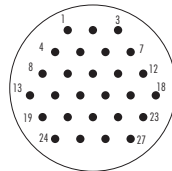

Connectors with non-removable contacts

Connectors with removable contacts

Accessories

Technical guides

Identification of the contacts on the solder, crimp side

- Male panel connector
Male cable connector
- ◉ Female panel connector
Female cable connector
- contact ø 0,76 mm

Contact arrangement

Miniature, Natto Miniature Push-Pull, Marine, Neptunox, Robotic and Minex Series

Housing 00

3 contacts
3 x ø 1 mm
Natto Miniature Push-Pull, Minex Series



Housing 00

4 contacts
4 x ø 1 mm
Natto Miniature Push-Pull, Minex Series



Housing 0

7 contacts
7 x ø 1 mm
Natto Miniature Push-Pull, Minex Series



Housing 1

12 contacts
12 x ø 1 mm
Natto Miniature Push-Pull, Miniature, Marine, Neptunox, Robotic Series

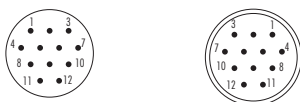

Housing 1

19 contacts
19 x ø 1 mm
Natto Miniature Push-Pull, Miniature, Marine, Neptunox, Robotic Series



Housing 2

27 contacts
27 x ø 1 mm
Miniature, Marine, Neptunox, Robotic Series

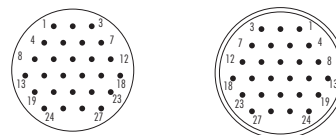

Housing 2

37 contacts
37 x ø 1 mm
Miniature, Marine, Neptunox, Robotic Series

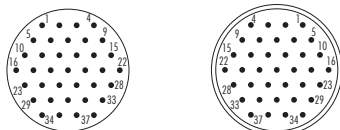

Housing 3

55 contacts
55 x ø 1 mm
Miniature Series

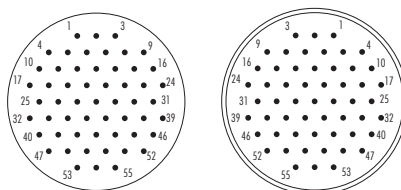

Identification of the contacts on the solder, crimp side

- Male panel connector
- Female panel connector
- contact ø 1 mm
- Male cable connector
- Female cable connector

Natto Miniature Push-Pull, Industrial, Marine, Neptunox and Robotic Series

ø 1,6 mm and ø 2,4 mm

Housing 1

3 contacts
3 x ø 1,6 mm
Natto Miniature Push-Pull, Industrial, Marine, Neptunox Series



Housing 1

4 contacts
4 x ø 1,6 mm
Natto Miniature Push-Pull, Industrial, Marine, Neptunox Series



Housing 1

7 contacts
7 x ø 1,6 mm
Natto Miniature Push-Pull, Industrial, Marine, Robotic Series



Housing 2

12 contacts
12 x ø 1,6 mm
Industrial, Marine, Neptunox Series

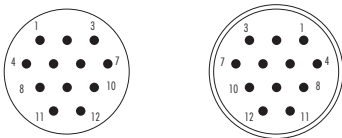

Housing 3

19 contacts
19 x ø 1,6 mm
Industrial Series

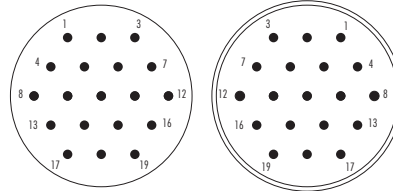

Housing 3

27 contacts
27 x ø 1,6 mm
Industrial Series

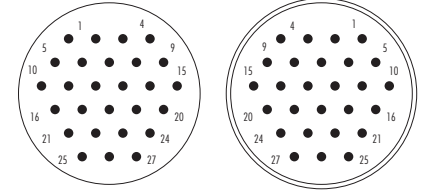

Housing 1

3 contacts
3 x ø 2,4 mm
Natto Miniature Push-Pull, Industrial, Marine, Neptunox Series



Housing 1

4 contacts
4 x ø 2,4 mm
Natto Miniature Push-Pull, Industrial, Marine, Neptunox, Robotic Series



Housing 2

7 contacts
7 x ø 2,4 mm
Industrial, Marine, Neptunox Series

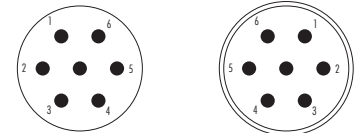

Housing 3

12 contacts
12 x ø 2,4 mm
Industrial Series

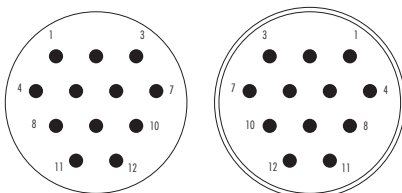

Identification of the contacts on the solder, crimp side

- Male panel connector
Male cable connector
- ⊙ Female panel connector
Female cable connector
- contact ø 1,6 mm
- contact ø 2,4 mm

Power Series Puissance

Housing 5

Single-pole connector

1 x \varnothing 8 mm or 1 x \varnothing 12 mm

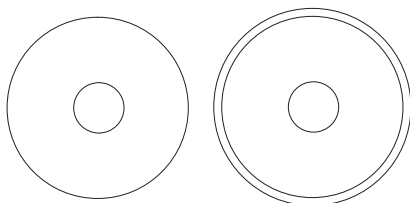

Housing 5

Multi-pole connector

3 contacts x \varnothing 8 mm + 2 pilot contacts \varnothing 1,6 mm

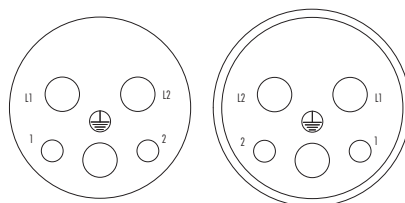

Housing 5

Multi-pole connector

3 contacts \varnothing 8 mm „Economic“

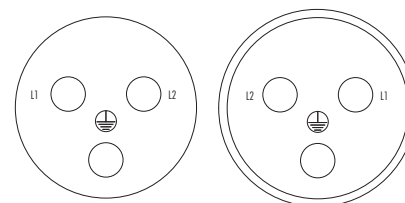

Housing 5

Multi-pole connector

4 contacts x \varnothing 8 mm

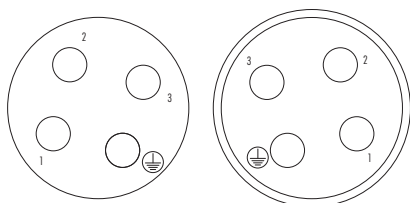

Identification of the contacts on the solder side

○ Male panel connector
Male cable connector

⊙ Female panel connector
Female cable connector

○ contact \varnothing 1,6 mm

○ contact \varnothing 8 mm

○ contact \varnothing 12 mm

Industrial and Robotics Series with 17 mixed contacts

Housing

17 contacts

13 contacts x \varnothing 1 mm + 4 contacts \varnothing 2,4 mm

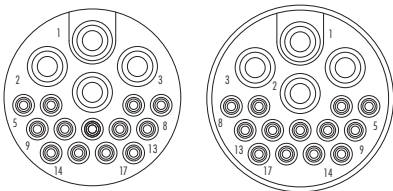

Identification of the contacts on the solder side

- Male panel connector
Male cable connector
- ◉ Female panel connector
Female cable connector
- ⊙ contact \varnothing 1 mm
- ⊚ contact \varnothing 2,4 mm

Neptunox Series

Housing 00
7 x \varnothing 0,76 mm

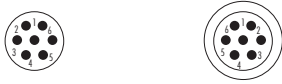

Housing 0
8 x \varnothing 0,76 mm



Housing 0
12 x \varnothing 0,76 mm

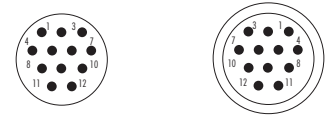

Housing 0
19 x \varnothing 0,76 mm



Housing 00
3 x \varnothing 1 mm



Housing 00
4 x \varnothing 1 mm



Housing 0
7 x \varnothing 1 mm



Housing 1
12 x \varnothing 1 mm

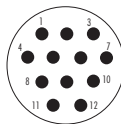

Housing 1
19 x \varnothing 1 mm

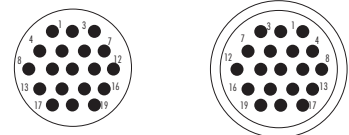

Housing 2
27 x \varnothing 1 mm

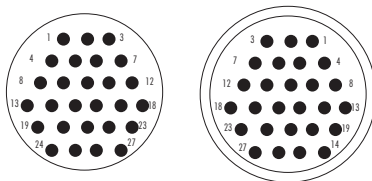

Housing 2
37 x \varnothing 1 mm

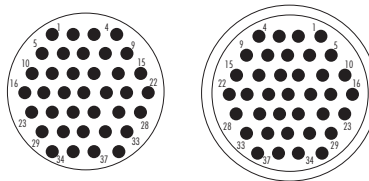

Identification of the contacts on the solder, crimp side

- Male panel connector
 - Female panel connector
 - contact \varnothing 0,76 mm
 - contact \varnothing 1 mm
- Male cable connector
 Female cable connector

Neptunox Series

Housing 1
3 x \varnothing 1,6 mm

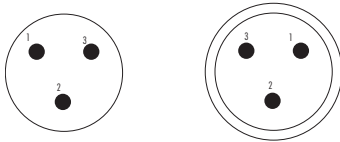

Housing 1
4 x \varnothing 1,6 mm

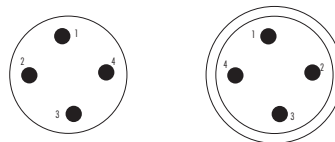

Housing 1
7 x \varnothing 1,6 mm

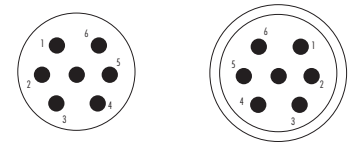

Housing 2
12 x \varnothing 1,6 mm

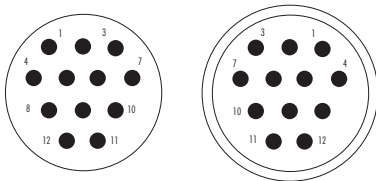

Housing 1
3 x \varnothing 2,4 mm

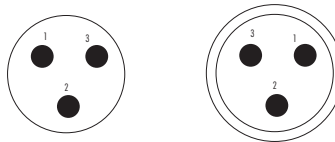

Housing 1
4 x \varnothing 2,4 mm

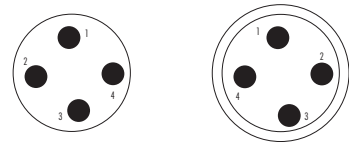

Housing 2
7 x \varnothing 2,4 mm

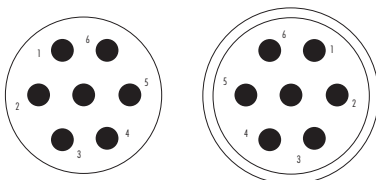

Identification of the contacts on the solder, crimp side

- Male panel connector
Male cable connector
- ⊙ Female panel connector
Female cable connector
- contact \varnothing 1,6 mm
- contact \varnothing 2,4 mm

Panel connector

There are two possible combinations.

- A panel connector and cable connector assembly
- A coupler connector and cable connector assembly.

Ensure the parts are mounted the right way round as shown in the diagrams.

Non-removable contacts

- Identification of the contacts by numbers on both sides of the panel connector, the cable connector or the coupler connector insert.

1. Remove the sheath* from the cables and strip* the wires.
2. Take the rear of the panel connector and solder* each stripped wire to its contact, according to your wiring diagram.

* For further information, refer to the „Wiring“ document.

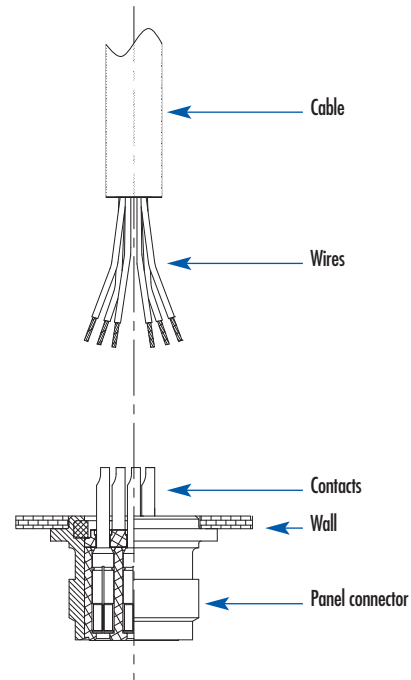

Coupler connector

For assembly, refer to the Connector part opposite

Choice of 3 types of cable clamp

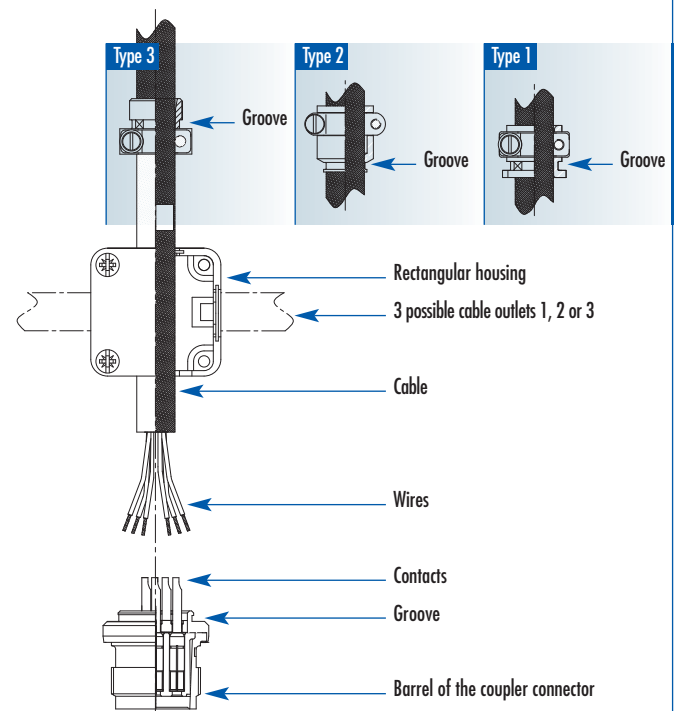

Cable connector

Choice of 3 types of cable clamp

1. Unscrew the 4 screws and open the two half-shells of the housing. Separate the parts.

(2 half-shells and a cable connector barrel).

2. Slide the cable into the cable clamp.

3. Remove the sheath* from the cables and strip* the wires.

4. Take the rear of the cable connector barrel and solder* each stripped wire to its contact, according to your wiring diagram.

5. Take a half-shell and place the groove of the cable connector barrel and the groove of the cable clamp into it in their respective seatings as shown in diagram 1 tighten the 2 screws on the cable clamp.

6. Then close the assembly with the other half-shell, using the 4 screws.

* For further information, refer to the „Wiring“ document.

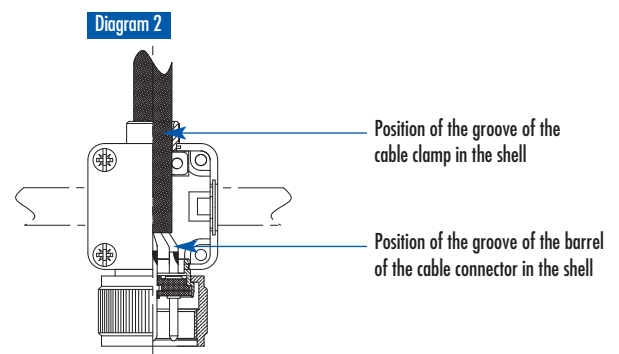
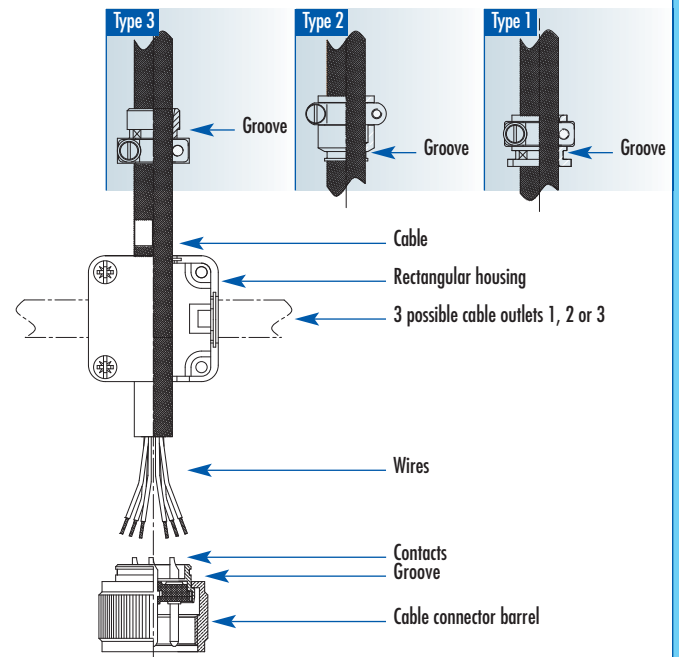

Panel connector

There are two possible combinations.

- A panel connector and cable connector assembly
- A coupler connector and cable connector assembly.

Ensure the parts are mounted the right way round as shown in the diagrams.

Non-removable contacts

- Identification of the contacts by numbers on both sides of the panel connector, the cable connector or the coupler connector insert. For further information, refer to the „Contact arrangement“ document.

1. Remove the sheath* from the cables and strip* the wires.
2. Take the rear of the panel connector and solder* each stripped wire to its contact, according to your wiring diagram.

* For further information, refer to the „Wiring“ document.

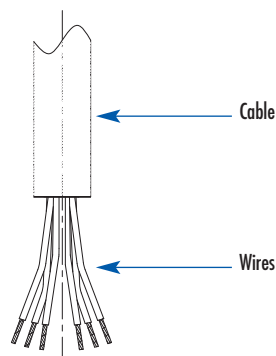

Round panel connector

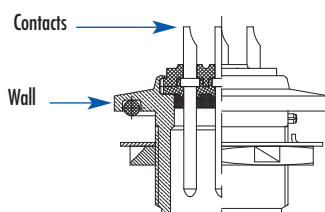

Square panel connector

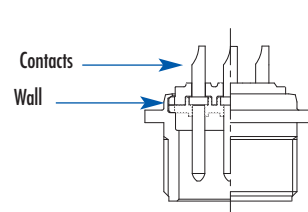

Coupler connector

For assembly, refer to the connector part (Standard Weatherproof) opposite

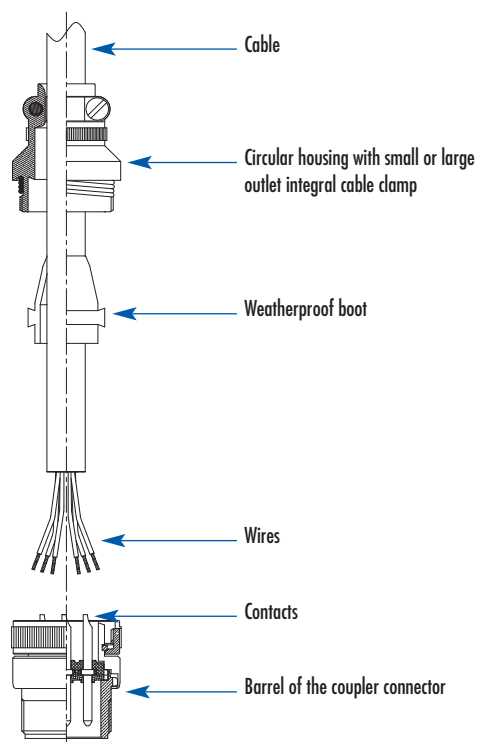

Assembly – Weatherproof, Weatherproof High-Performance and PG outlet Series

Cable connector

Standard Weatherproof

1.
Unscrew all the parts of the cable connector.
2.
Slide the cable into the circular housing with its integral cable clamp, followed by the weatherproof boot.
3.
Remove the sheath* from the cables and strip* the wires.
4.
Take the rear of the cable connector barrel and solder* each stripped wire to its contact, according to your wiring diagram.
5.
Next fit the weatherproof boot inside the circular housing. Then screw the assembly onto the barrel of the cable connector.
6.
Tighten the 2 screws on the cable clamp.

* For further information, refer to the „Wiring“ document.

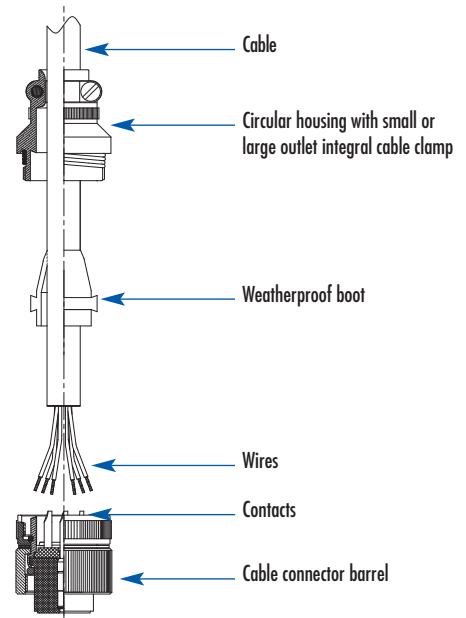

Weatherproof High-Performance Cable Gland and PG outlet

1.
Unscrew all the parts of the cable connector.
2.
Slide the cable into the circular housing with its integral cable clamp, followed by the weatherproof boot.
- 3., 4., 5. and 6. refer to instructions 3., 4., 5. and 6. above.

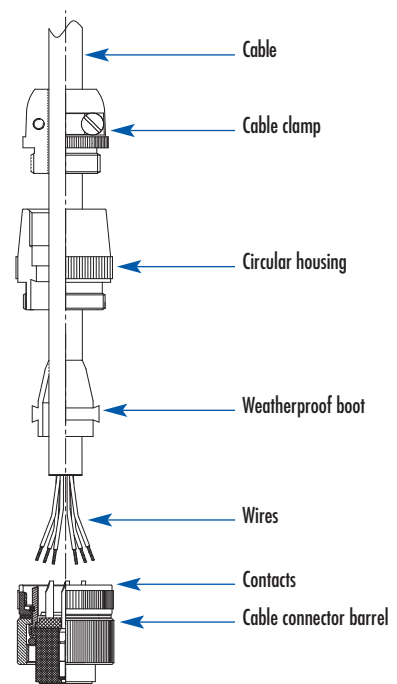

Panel connector

There are two possible combinations.

- A panel connector and cable connector assembly
- A coupler connector and cable connector assembly.

Ensure the parts are mounted the right way round as shown in the diagrams.

Removable contacts

All the contacts must be mounted in the insert.

- Identification of the contacts by numbers on both sides of the panel connector, the cable connector or the coupler connector insert. For further information, refer to the „Contact arrangement“ document.

1. Remove the sheath* from the cables and strip* the wires.
2. Solder* or crimp each stripped wire onto its contact.
3. Then take the rear of the panel connector and insert* the wired contacts into the insert using the insertion tool*, according to your wiring diagram.

* For further information, refer to the „Wiring“ document

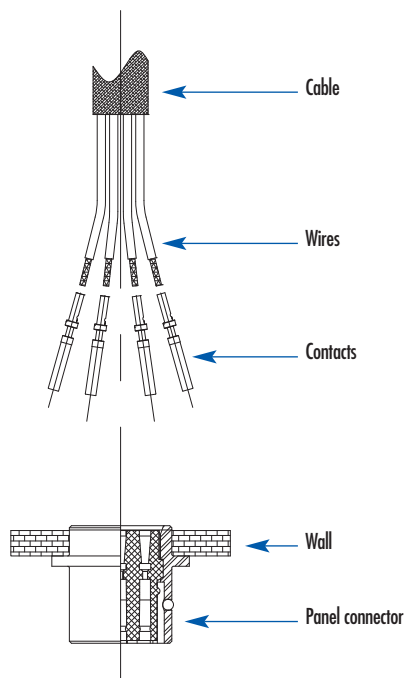

Coupler connector

For assembly, refer to the Connector part opposite

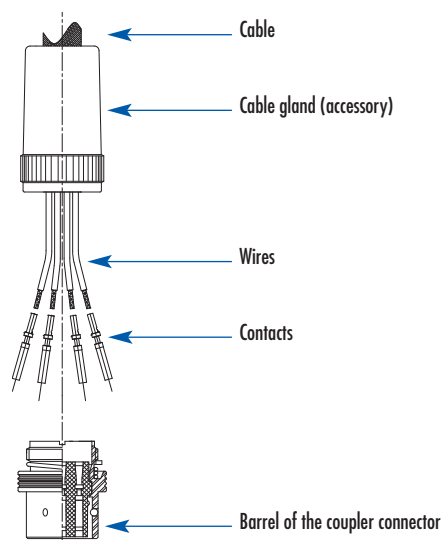

Cable connector

Connection accessories Choice of 3 couplings:

Cable gland

1. Unscrew all the parts of the cable connector.
2. Slide the cable into the cable gland coupling, followed by the claw, the cable gland seal and the seal holder.
3. Remove the sheath* from the cables and strip* the wires.
4. Solder* or crimp each stripped wire onto its contact.
5. Then take the rear of the cable connector barrel and insert* the wired contacts into the insert using the insertion tool*, according to your wiring diagram.
6. Next join all the parts of the connection accessory together. Then screw the assembly onto the barrel of the cable connector.

* For further information, refer to the „Wiring“ document.

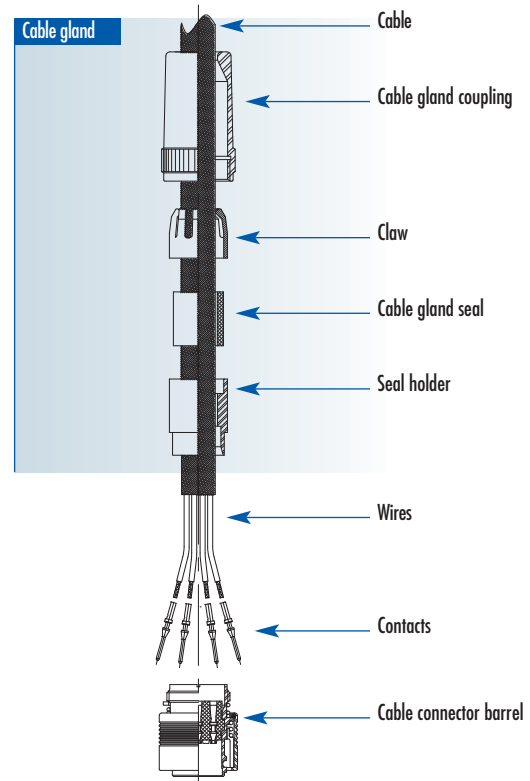

Cable clamp

1. Unscrew all the parts of the cable connector.
2. Slide the cable into the coupling, followed by the washer, the seal and the seal holder.
3. 4., 5. and 6. refer to instructions 3., 4., 5. and 6. above.
7. Tighten the screws on the cable clamp.

Cable gland with 360° shield connection

1. Unscrew all the parts of the cable connector.
2. Slide the cable into the circular housing with its integral cable clamp, followed by the weatherproof boot.
- 3., 4., 5. and 6. refer to instructions 3., 4., 5. and 6. above.

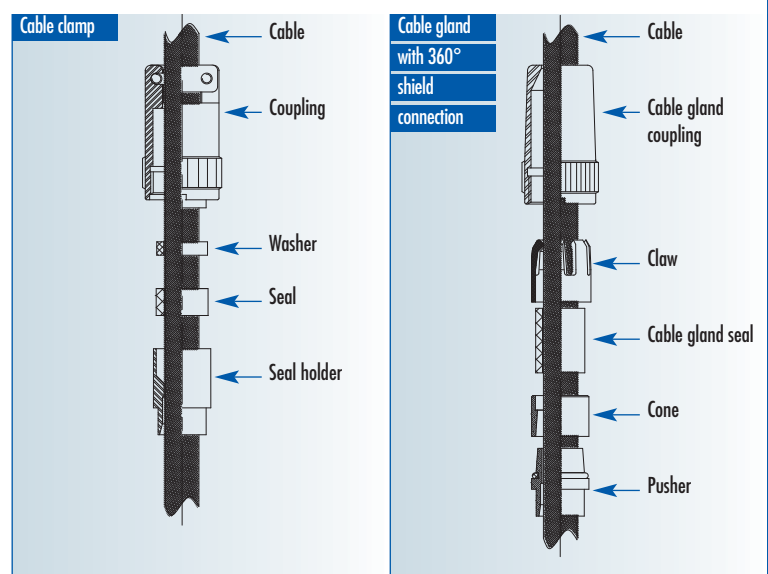

Panel connector

There are two possible combinations.

- A panel connector and cable connector assembly
- A coupler connector and cable connector assembly.

Ensure the parts are mounted the right way round as shown in the diagrams.

Removable contacts

All the contacts must be mounted in the insert.

- Identification of the contacts by numbers on both sides of the panel connector, the cable connector or the coupler connector insert. For further information, refer to the „Contact arrangement“ document.

1. Remove the sheath* from the cables and strip* the wires.
2. Solder* or crimp each stripped wire onto its contact.
3. Then take the rear of the panel connector and insert* the wired contacts into the insert using the insertion tool*, according to your wiring diagram.

* For further information, refer to the „Wiring“ document.

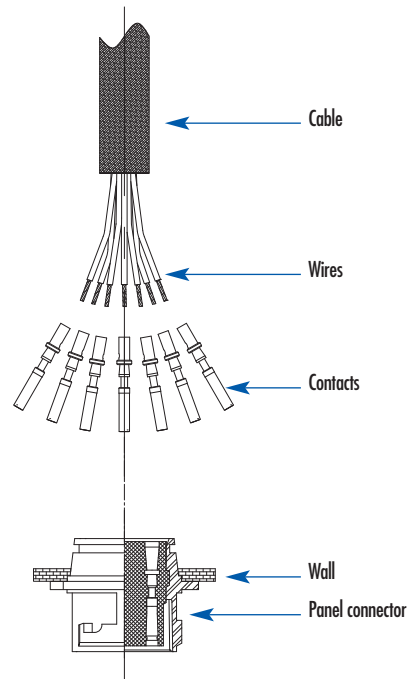

Coupler connector

For assembly, refer to the Connector part opposite

Choice of 3 types of cable clamp (accessory)

(for further information, refer to the „Cable clamp“ document)

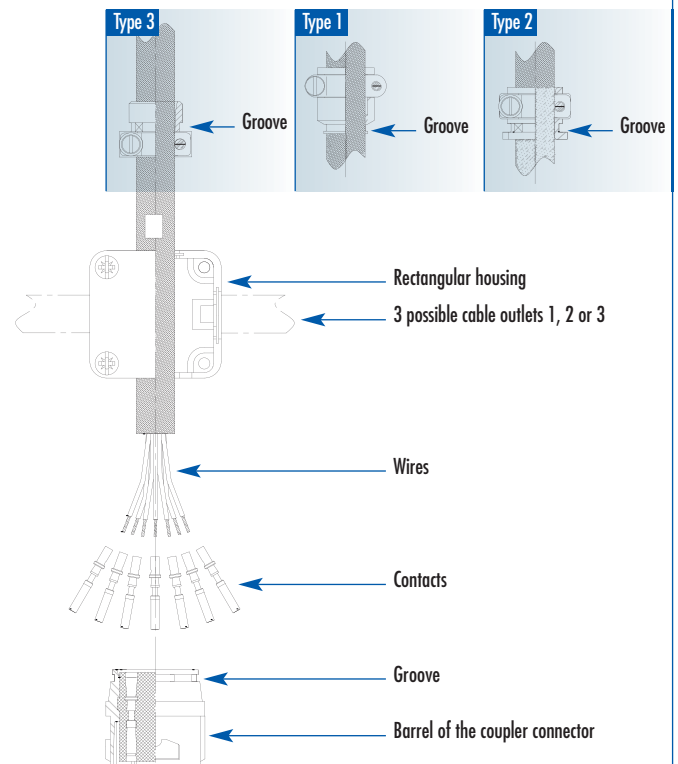

Cable connector

Choice of 3 types of cable clamp (accessory)

(for further information, refer to the „Cable clamp“ document)

Cable gland

1.
Unscrew the screws and open the two half-shells of the housing.
Separate the parts.

(2 half-shells and a cable connector barrel).

2.
Slide the cable into the cable clamp.

3.
Remove the sheath* from the cables and strip* the wires.

4.
Solder* or crimp each stripped wire onto its contact.

5.
Then take the rear of the cable connector barrel and insert* the wired contacts into the insert using the insertion tool*, according to your wiring diagram.

6.
Take a half-shell and place the groove of the cable clamp and the groove of the cable connector barrel into it, in their respective seatings according to diagram 1.
Tighten the screws on the cable clamp.

7.
Then close the assembly with the other half-shell, using the 4 screws.

* For further information, refer to the „Wiring“ document.

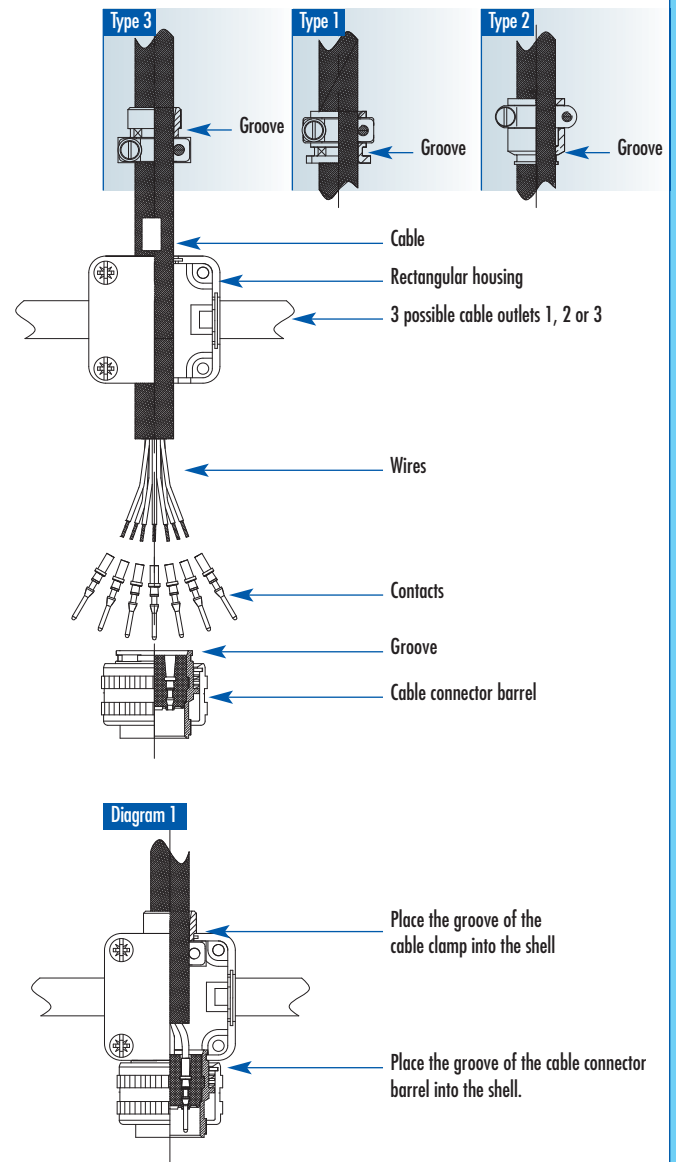

Panel connector

There are two possible combinations.

- A panel connector and cable connector assembly
- A coupler connector and cable connector assembly.

Ensure the parts are mounted the right way round as shown in the diagrams.

Removable contacts

All the contacts must be mounted in the insert.

- Identification of the contacts by numbers on both sides of the panel connector, the cable connector or the coupler connector insert.

For further information, refer to the „Contact arrangement“ document.

1. Remove the sheath* from the cables and strip* the wires.
2. Solder* or crimp each stripped wire onto its contact.
3. Then take the rear of the panel connector and insert* the wired contacts into the insert using the insertion tool*, according to your wiring diagram.

* For further information, refer to the „Wiring“ document.

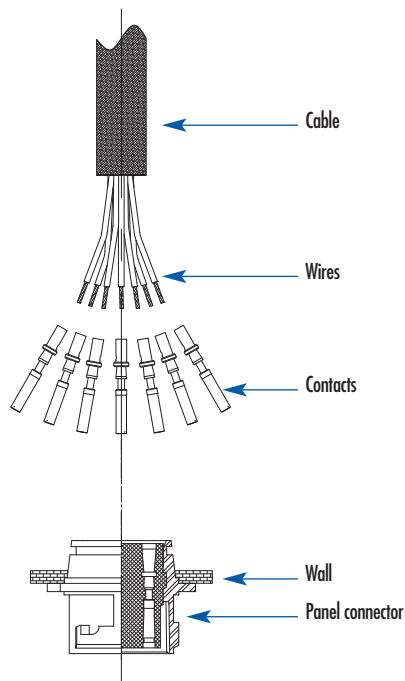

Coupler connector

For assembly, refer to the Connector part opposite

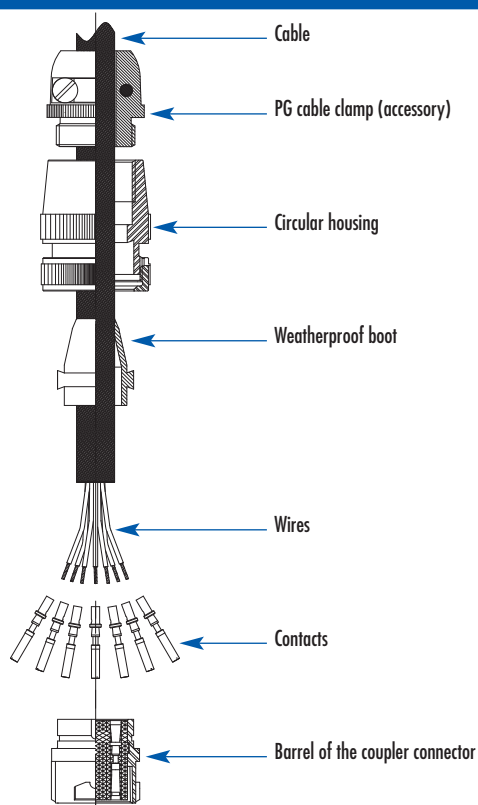

Cable connector

1. Unscrew all the parts of the cable connector.
2. Slide the cable into the cable clamp, followed by the circular housing and the weatherproof boot.
3. Remove the sheath* from the cables and strip* the wires.
4. Solder* or crimp each stripped wire onto its contact.
5. Then take the rear of the cable connector barrel and insert* the wired contacts into the insert using the insertion tool*, according to your wiring diagram.
6. Next fit the weatherproof boot inside the circular housing. Then screw the assembly onto the barrel of the cable connector.
7. Tighten the screws on the cable clamp.

* For further information, refer to the „Wiring“ document.

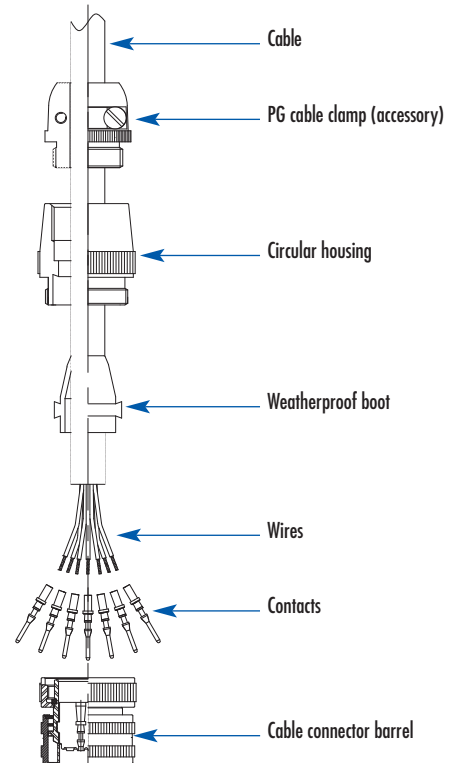

Panel connector

There are two possible combinations.

- A panel connector and cable connector assembly
- A coupler connector and cable connector assembly.

Ensure the parts are mounted the right way round as shown in the diagrams.

Removable contacts

All the contacts must be mounted in the insert.

- Identification of the contacts by numbers on both sides of the panel connector, the cable connector or the coupler connector insert. For further information, refer to the „Contact arrangement“ document.

1. Remove the sheath* from the cables and strip* the wires.
2. Solder* or crimp each stripped wire onto its contact.
3. Then take the rear of the panel connector and insert* the wired contacts into the insert using the insertion tool*, according to your wiring diagram.

* For further information, refer to the „Wiring“ document.

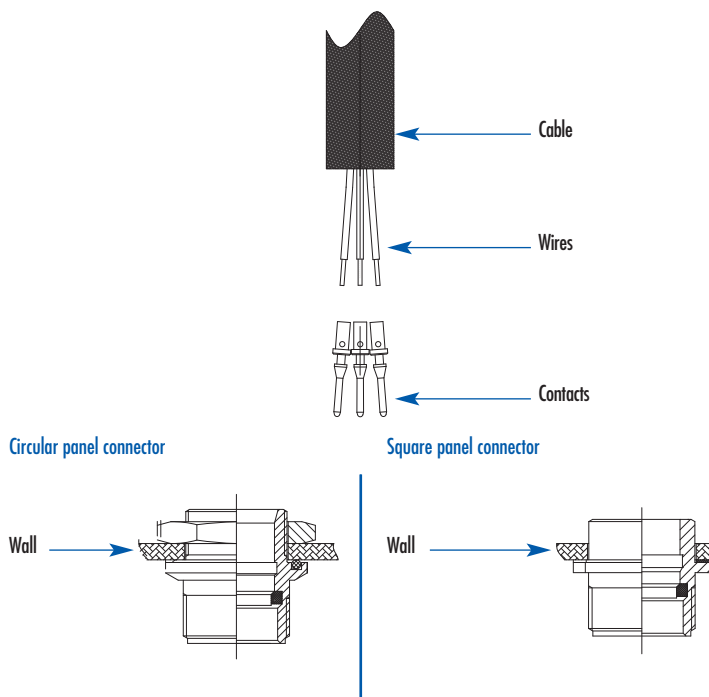

Coupler connector

For assembly, refer to the Connector part opposite

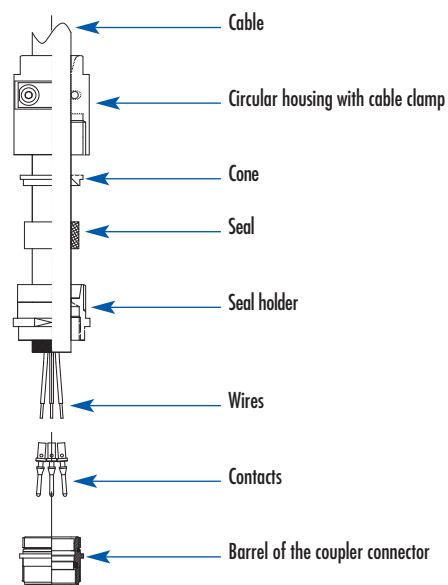

Cable connector

1.
Unscrew all the parts of the cable connector.
2.
Slide the cable into the cable clamp, followed by the cone, the seal and the seal holder
3.
Remove the sheath* from the cables and strip* the wires.
4.
Solder* or crimp each stripped wire onto its contact.
5.
Then take the rear of the cable connector barrel and insert* the wired contacts into the insert using the insertion tool*, according to your wiring diagram.
6.
Next add the cone followed by the seal and the seal holder in the circular housing with the cable clamp incorporated. Then screw the assembly onto the barrel of the cable connector.
7.
Tighten the screws on the cable clamp.

* For further information, refer to the „Wiring“ document.

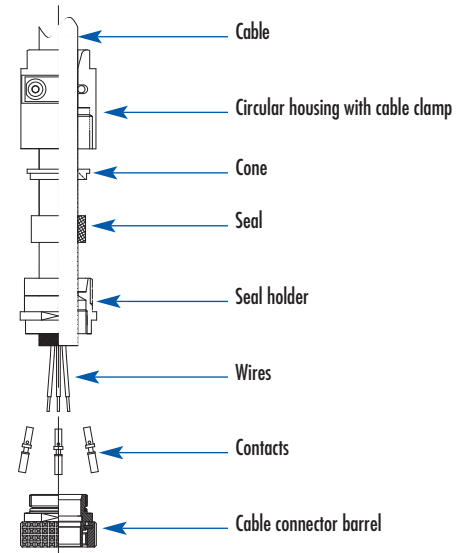

Panel connector

There are two possible combinations.

- A panel connector and cable connector assembly
- A coupler connector and cable connector assembly.

Ensure the parts are mounted the right way round as shown in the diagrams.

Removable contacts

All the contacts must be mounted in the insert.

- Identification of the contacts by numbers on both sides of the panel connector, the cable connector or the coupler connector insert. For further information, refer to the „Contact arrangement“ document.

1. Remove the sheath* from the cables and strip* the wires.
2. Solder* or crimp each stripped wire onto its contact.
3. Then take the rear of the panel connector and insert* the wired contacts into the insert using the insertion tool*, according to your wiring diagram.

* For further information, refer to the „Wiring“ document.

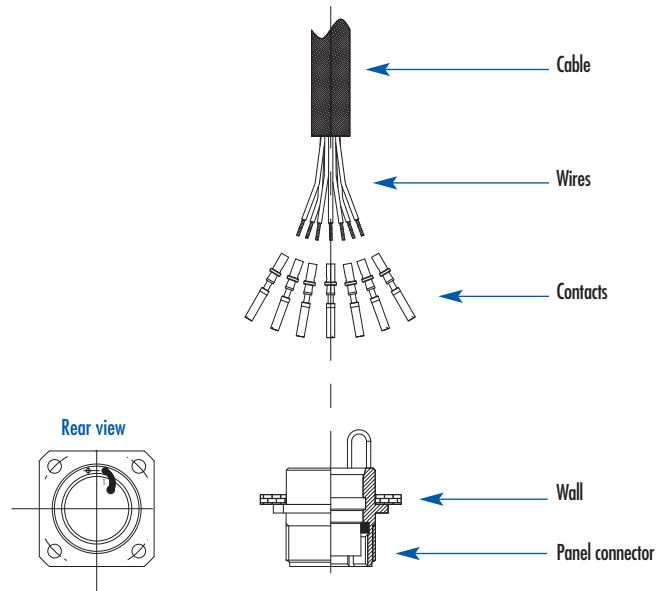

Coupler connector

For assembly, refer to the Connector part opposite

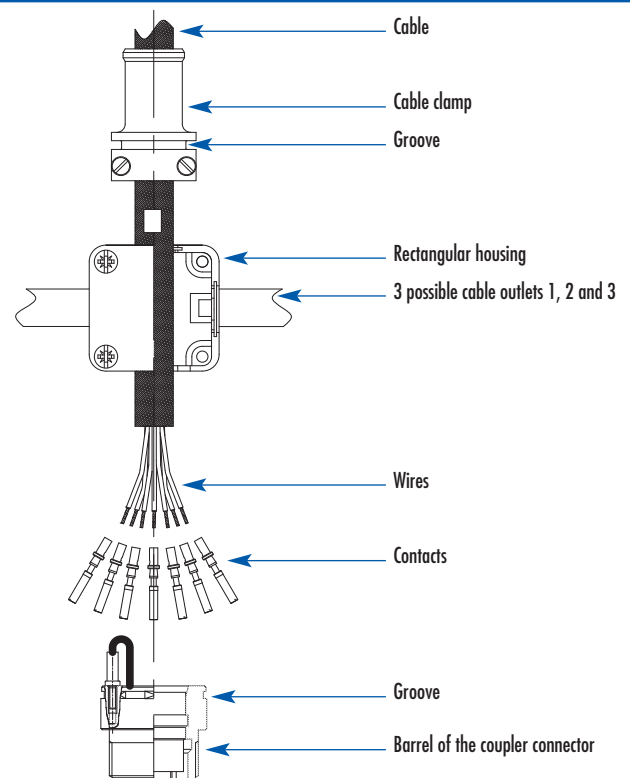

Cable connector

1. Unscrew the screws and open the two half-shells of the housing. Separate the parts.
(2 half-shells and a cable connector barrel).
2. Slide the cable into the cable clamp.
3. Remove the sheath* from the cables and strip* the wires.
4. Solder* or crimp each stripped wire onto its contact.
5. Then take the rear of the cable connector barrel and insert* the wired contacts into the insert using the insertion tool*, according to your wiring diagram.
6. Take a half-shell and place the groove of the cable clamp and the groove of the cable connector barrel into it, in their respective seatings according to diagram 1. Tighten the screws on the cable clamp.
7. Then close the assembly with the other half-shell, using the 4 screws.

* For further information, refer to the „Wiring“ document.

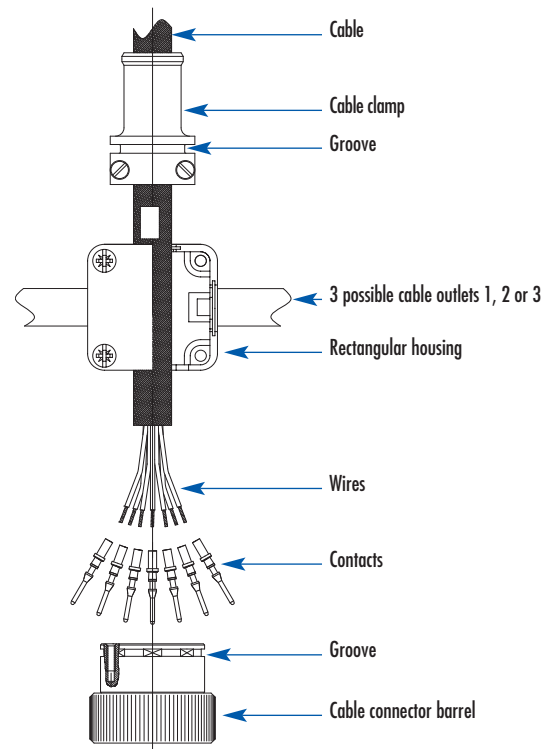
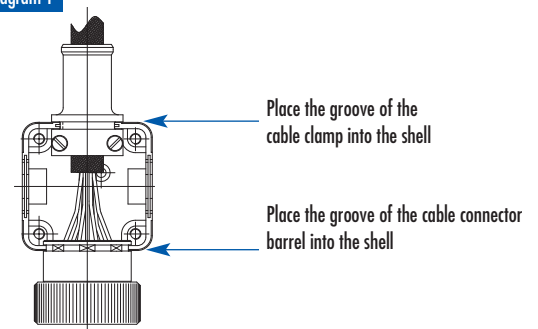

Diagram 1



Panel connector

There are two possible combinations.

- A panel connector and cable connector assembly
- A coupler connector and cable connector assembly.

Ensure the parts are mounted the right way round as shown in the diagrams.

Removable contacts

All the contacts must be mounted in the insert.

- Identification of the contacts by numbers on both sides of the panel connector, the cable connector or the coupler connector insert. For further information, refer to the „Contact arrangement“ document.

1.
Remove the sheath* from the cables and strip* the wires.

2.
Solder* or crimp each stripped wire onto its contact.

3.
Then take the rear of the panel connector and insert* the wired contacts into the insert using the insertion tool*, according to your wiring diagram.

* For further information, refer to the „Wiring“ document.

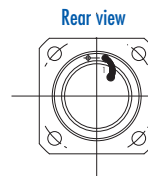
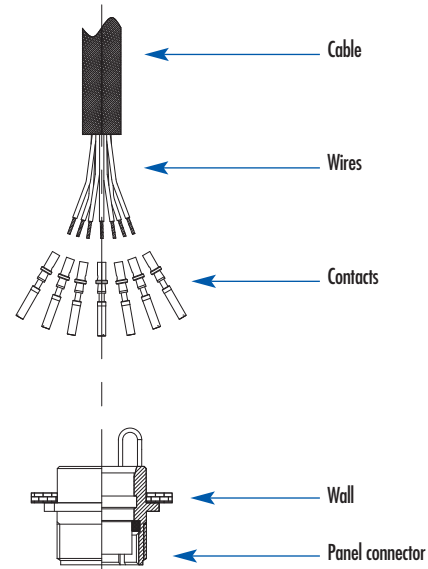

Coupler connector

For assembly, refer to the Connector part opposite

Cable connector

Diagram 1

1. Unscrew the screws and open the two half-shells of the housing. Then separate the parts.

(2 half-shells and a cable connector barrel).

2. Slide the cable into the cable clamp, the pressure washer, the thermo-adhesive sheath and the boot.

3. Solder* or crimp each stripped wire onto its contact. Then take the rear of the cable connector barrel and insert the wired contacts into the insert using the insertion tool, according to your wiring diagram.

* For further information, refer to the „Wiring“ document.

Diagram 2

4. Install the boot at the rear of the cable connector barrel. Place the toothed washer initially between the pressure washer and the boot (required for the ground connection).

Diagram 3

5. Fit the 4 screws starting by the one linked to the toothed washer (screw A). Fully tighten the 4 screws on the pressure washer.

Diagram 4

6. Place the thermo-adhesive sheath on the boot/cable. Stretch the thermo-adhesive sheath on the boot and the cable conduit, taking care to heat the thermo-adhesive sheath evenly to $\pm 100\text{ }^{\circ}\text{C}$ in order to completely liquefy the adhesive.

Diagram 5

7. Take a half-shell and place the groove of the cable clamp and the groove of the cable connector barrel into it, in their respective seatings. Tighten the screws on the cable clamp. Then close the assembly with the other half-shell, using the 4 screws.

Diagram 1

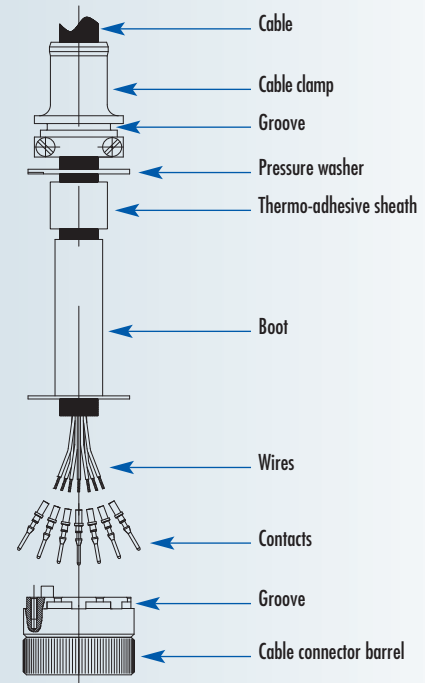

Diagram 2

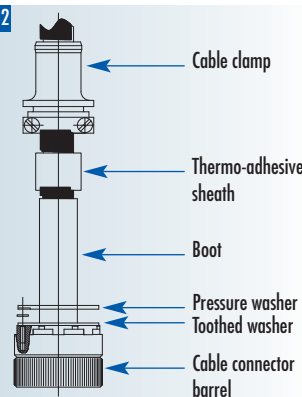

Diagram 3

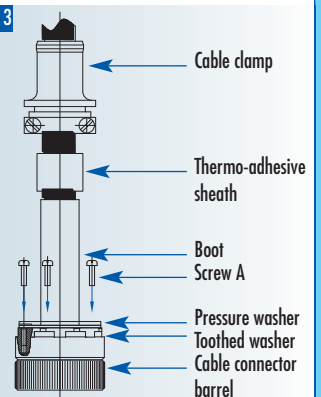

Diagram 4

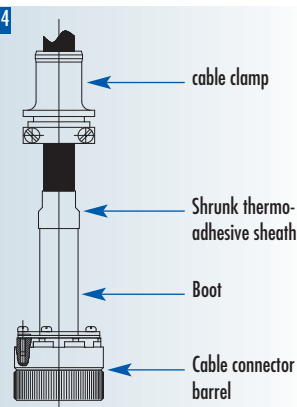
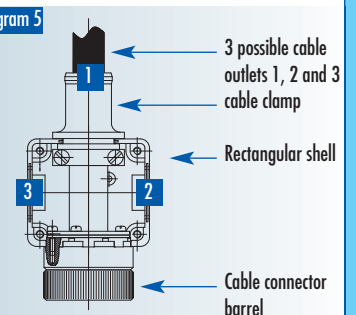

Diagram 5



Panel connector

There are two possible combinations.

- A panel connector and cable connector assembly
- A coupler connector and cable connector assembly.

Ensure the parts are mounted the right way round as shown in the diagrams.

Removable contacts

All the contacts must be mounted in the insert.

- Identification of the contacts by numbers on both sides of the panel connector, the cable connector or the coupler connector insert. For further information, refer to the „Contact arrangement“ document.

1. Remove the sheath* from the cables and strip* the wires.
2. Solder* or crimp each stripped wire onto its contact.
3. Then take the rear of the panel connector and insert* the wired contacts into the insert using the insertion tool*, according to your wiring diagram.

* For further information, refer to the „Wiring“ document.

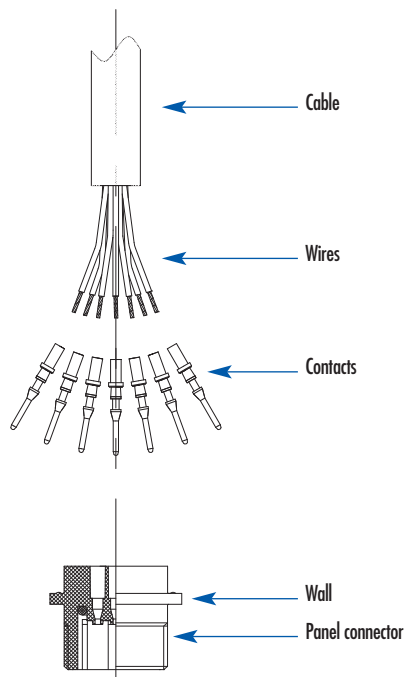

Coupler connector

For assembly, refer to the Connector part opposite

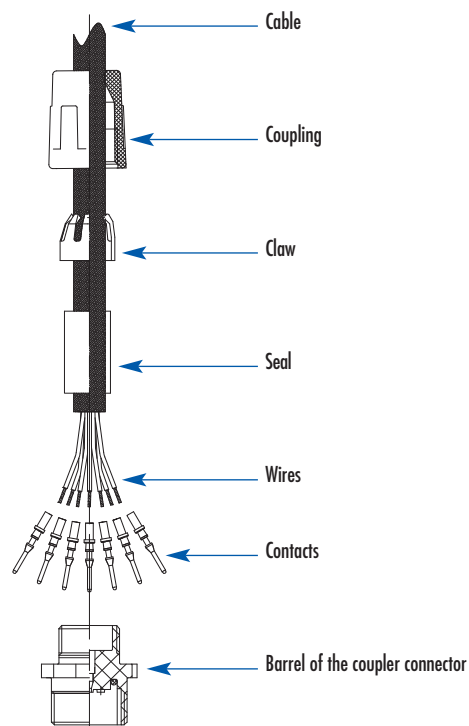

Cable connector

1.
Unscrew all the parts of the cable connector.
2.
Slide the cable into the coupling, followed by the claw and the seal.
3.
Remove the sheath* from the cables and strip* the wires.
4.
Solder* or crimp each stripped wire onto its contact.
5.
Then take the rear of the cable connector barrel and insert* the wired contacts into the insert using the insertion tool*, according to your wiring diagram.
6.
Next add the claw followed by the seal in the coupling.
Then screw the assembly with the barrel of the cable connector.

* For further information, refer to the „Wiring“ document.

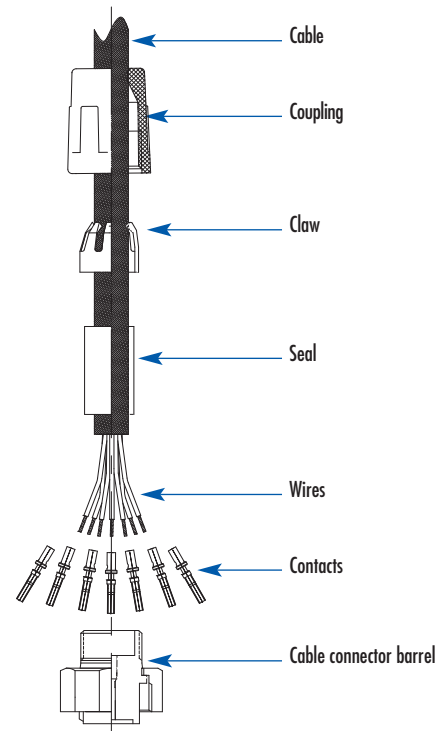

Panel connector

There are two possible combinations.

- A panel connector and cable connector assembly
- A coupler connector and cable connector assembly.

Ensure the parts are mounted the right way round as shown in the diagrams.

Removable contacts

All the contacts must be mounted in the insert.

- Identification of the contacts by numbers on both sides of the panel connector, the cable connector or the coupler connector insert. For further information, refer to the „Contact arrangement“ document.

1.
Remove the sheath* from the cable and slide each wire into its bushing. Strip* the wires.

2.
Crimp* each stripped wire to its contact.

3.
Then take the rear of the panel connector and insert the wired contacts into the insert, according to your wiring diagram. Then insert the bushings, screwing them up using the specific tool*.

* For further information, refer to the „Wiring“ document.

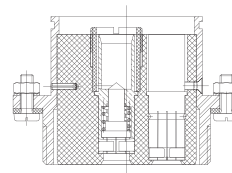

Panel connector

Coupler connector

For assembly, refer to the Connector part opposite

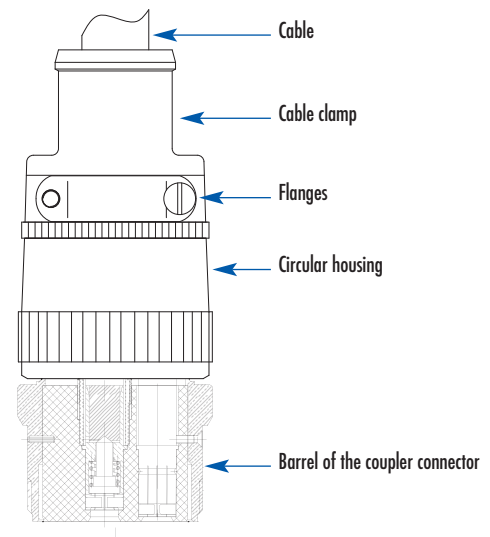

Cable connector

1. Unscrew all the parts of the cable connector.
2. Slide the cable into the cable gland with the flanges loosened, followed by the straight coupling, the friction washer and the nut.
3. Remove the sheath* from the cable and slide each wire into its bushing. Strip* the wires.
4. Crimp* each stripped wire to its contact.
5. Then take the rear of the cable connector barrel and insert* the wired contacts into the insert, according to your wiring diagram. Then insert the bushings, screwing them up using the specific tool*.
 - Place the ground contact in its seating, taking care to position the hole of contact „X“ in line with the hole „S“ of the cable connector barrel. Attach the ground contact with the ground screw.
 - For cable connectors with male contacts, only on the pilot contacts, first insert the socket holders, then the wired pilot contacts and finish with the bushings.
6. Add the nut and the friction washer and the straight coupling and screw the assembly to the cable connector barrel.
7. Screw the cable clamp onto the straight coupling. Tighten the screws on the cable clamp. Apply weak threadlock on the threaded part of the cable clamp.

* For further information, refer to the „Wiring“ document.

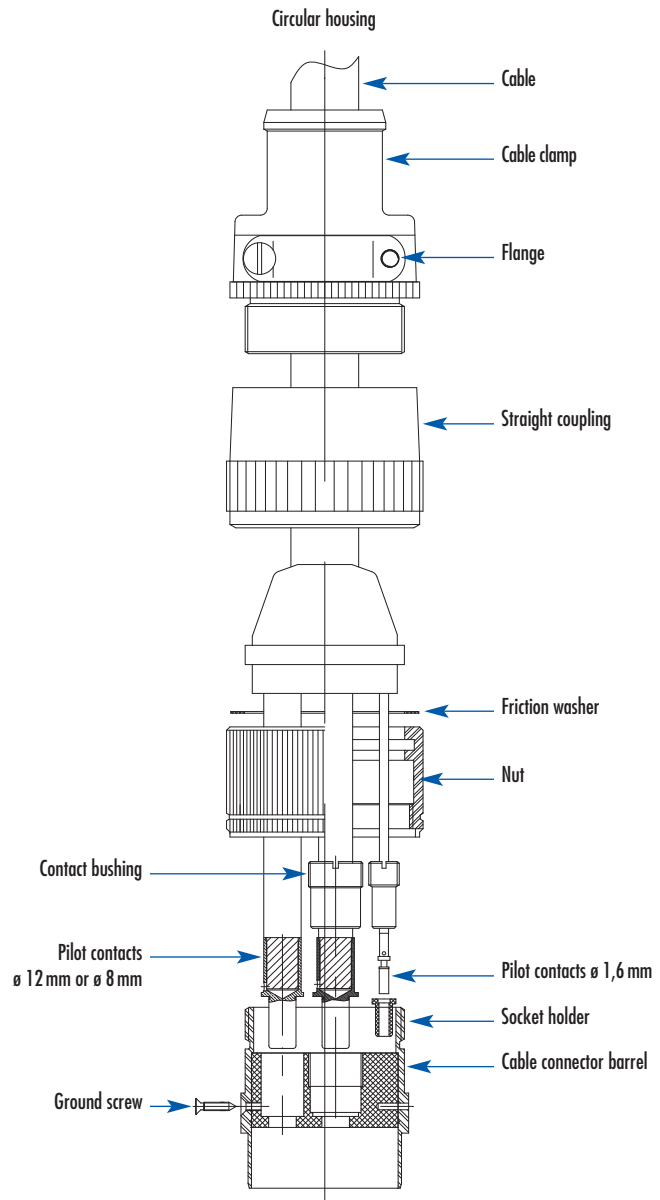

Attachment of panel connectors to a wall

Square and circular panel connectors for the Standard, Rapid, Weatherproof, Miniature, Industrial, Marine, Neptunox and Robotic

Housing	$\varnothing A$	$\varnothing B$	$\varnothing C$
1	3,2	28	21,2
2	3,2	34	27,2
3	4,2	48	39,2
4	4,2	54	45,2
5	4,2	62	52,2

4 holes $\varnothing A$ to 90° on $\varnothing B$

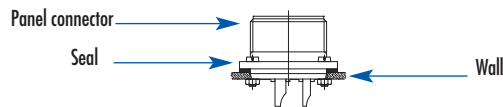
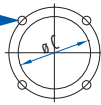

After drilling the holes in the wall (hole $\varnothing C$ and 4 holes $\varnothing A$), place the gasket* followed by the panel connector against the wall. Screw up using the 4 screws and nuts**.

The assembly is sealed by crushing the gasket between the wall and the panel connector.

*Gaskets under panel connector (not supplied with the panel connector), see: Accessories.

**Attachment of the square panel connector by 4 screws and nuts (not supplied with the panel connector), see: Accessories.

Housings B1 and B2: 4 screws and M3 nuts

Housings B3, B4 and B5: 4 screws and M4 nuts

Circular panel connectors: attachment by locknuts Standard, Weatherproof and Hermetic Series

The cutting out of the supporting wall, as shown below, may be different depending on the thickness of the wall.

Housing	$\varnothing M$	$\varnothing N$ min.	$\varnothing O$	P	Q	R
1	21,1	34	M21	2,5	24,9	23
2	27,1	40	M27	2,5	30,9	29
3	39,1	56,2	M39	2	41,4	40,2
4	45,1	62,2	Tr 45	1,6	47,4	46,2
5	52,1	69,2	Tr 52	2,1	54,4	53,2

Diagram 1: Thickness of the wall between 2 and 4 mm

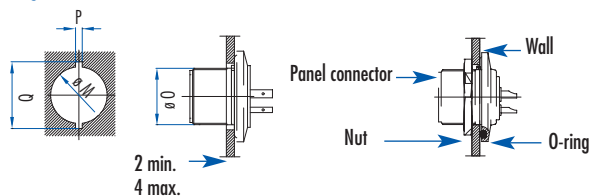
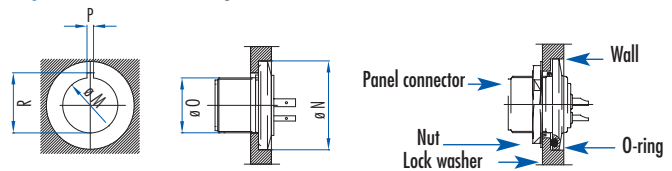

Diagram 2: Thickness of the wall greater than 4 mm



After drilling the holes in the wall, fit the O-ring in the groove on the collar of the panel connector. Then fit the panel connector, the lock washer and finally the nut.

The assembly is sealed by crushing the gasket between the wall and the panel connector.

Bulkhead connector for Hermetic Series

The cutting out of the supporting wall, as shown below, may be different depending on the thickness of the wall.

Thickness of the wall	B 1		B 2		B 3	B 4	B 5
	Diagram 1	Diagram 2	Diagram 1	Diagram 2	Diagram 1	Diagram 1	Diagram 1
A	2 to 10	2 to 10	2 to 10	2 to 10	2 to 10	2 to 10	2 to 10
A	ø 21		ø 27		ø 39,5	ø 45,5	ø 52,5
B	2,5		2,5		2,5	2,5	2,5
C	12,5		15,5		20,7	23,7	27,2

Diagram 1: Thickness of the wall between 2 and 10 mm

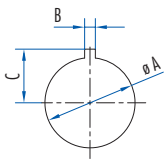
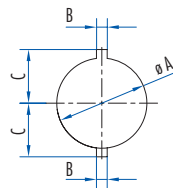
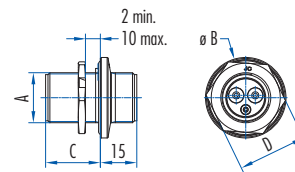

Diagram 2: Thickness of the wall greater than 10 mm



Bulkhead connector



After drilling the holes in the wall, fit the O-ring in the groove on the collar of the bulkhead connector. Then fit the bulkhead connector, the lock washer and finally the nut. The assembly is sealed by crushing the gasket between the wall and the bulkhead connector.

As the bulkhead connector is fitted with male contacts on both sides, the identification of the same conductor is different in the two female cable connectors mated to this connector. See the table of equivalences below.

Housing 1
3-4-6 contacts

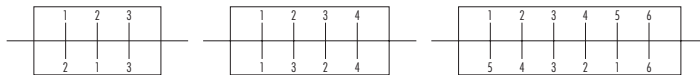

Housing 2
8-12 contacts

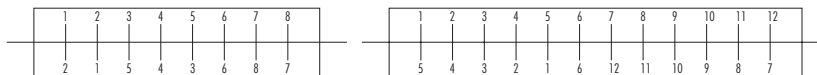

Housing 3
17 contacts



Housing 4
25 contacts



Housing 5
35 contacts



Housing 5
55 contacts

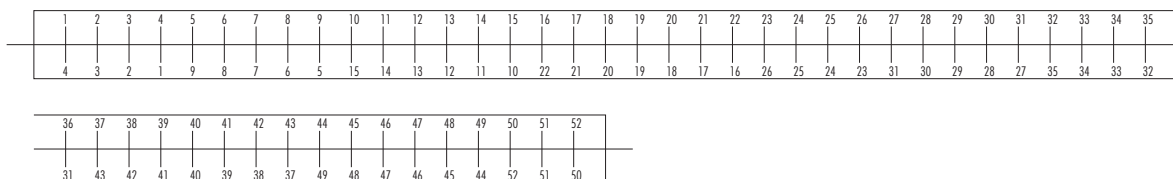

Attachment of panel connectors to a wall / Example of Cable clamp assembly

Push-Pull Series panel connectors

Housing	Number of Contacts		Square panel connector			Circular panel connector			
			ø A	ø B	ø C	ø A	B	C	D
00	ø 1 mm	3 - 4	12,3	2,7	18	12,7	13,6	3	11,6
0	ø 1 mm	7	15,3	2,7	21	16,2	17,1	3	15,1
1	ø 1 mm	12 - 19	21,9	3,2	28	21,2	23	2,5	20,1
1	ø 1,6 mm	3 - 4 - 7	21,9	3,2	28	21,2	23	2,5	20,1
1	ø 2,4 mm	3 - 4	21,9	3,2	28	21,2	23	2,5	20,1

Square panel connector

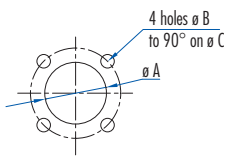

Circular panel connector: the panel connectors have the following two types of anti-rotation systems:

Diagram 1: Orientation using the tab on the lock washer.

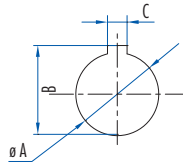
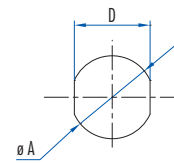

Diagram 2: Orientation using the flat sides on the panel connector barrel.



Standard, Rapid and Weatherproof Series

Assembly: Rectangular connectors (example)

- Open the two half-shells by unscrewing the 4 screws.
Separate the parts.
(2 half-shells and a cable connector barrel).
- Slide the cable into the cable clamp.
- Take the rear of the cable connector barrel and solder the wires to the corresponding contacts, according to your wiring diagram.
(For further information, refer to the „Wiring“ document).
- Take a half-shell. Place the groove of the cable connector barrel and the groove of the cable clamp into it in their respective seatings.
See diagram above. Tighten the 2 screws on the cable clamp.
- Then close the assembly with the other half-shell, using the 4 screws.

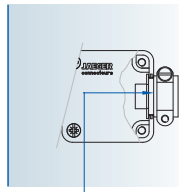

Place the groove of the cable clamp into the shell

Assembly: Circular connectors (example)

- Separate by unscrewing the barrel of the cable connector from its body.
- Slide the cable into the cable clamp, then into the body of the cable connector.
- Take the rear of the cable connector barrel and solder the wires to the corresponding contacts, according to your wiring diagram.
(For further information, refer to the „Wiring“ document).
- Assemble the barrel of the cable connector with its body, then assemble the cable clamp.
Tighten the 2 screws on the cable clamp.

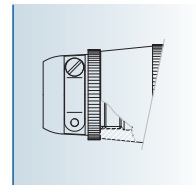

Miniature Push-Pull and Robotic Series

Assembly: (example: Robotic Series)

- Open the two half-shells by unscrewing the screws.
Then separate the parts.
(2 half-shells and a cable connector barrel).
- Slide the cable into the cable clamp.
- Solder or crimp the wires in the corresponding contacts
(For further information, refer to the „Wiring“ document).
Then, for connectors with removable contacts, take the cable connector barrel.
Insert the wired contacts into the insert, according to your wiring diagram.
- Take a half-shell and place the groove of the cable clamp and the groove of the cable connector barrel into it, in their respective seatings.
See the diagram opposite. Tighten the screws on the cable clamp.
- Then close the assembly with the other half-shell, using the screws.

Position of the groove of the cable clamp in the shell

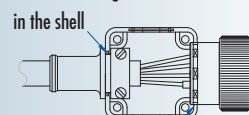

Cable connector barrel positioned in the shell

Assembly: Circular connectors (example)

- Separate by unscrewing the barrel of the cable connector from its body.
- Slide the cable into the cable clamp, then into the body of the cable connector.
- Take the rear of the cable connector barrel and solder the wires to the corresponding contacts, according to your wiring diagram.
(For further information, refer to the „Wiring“ document).
- Assemble the barrel of the cable connector with its body, then assemble the cable clamp. Tighten the screws on the cable clamp.

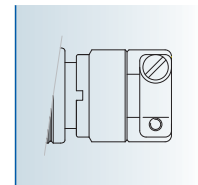

For the Miniature, Industrial, Marine and Robotic series

Each series is fitted with a polarisation system. This system ensures that when connecting, the correct cable connector is connected to the corresponding panel connector and that the contacts are correctly mated. 3 other polarisation systems are available to prevent mismatching between identical connectors (same series and same contact arrangement, see explanation below). This ensures that the correct cable connector is connected to the panel connector corresponding to it.

Polarisation is provided by:

- either the position of the secondary keys in relation to the main key.
- or by the rotation of the insert in the housing (this rotation is performed in a clockwise direction for male connectors and anti-clockwise for female connectors).

Keying type A:

Panel connector / Coupler connector

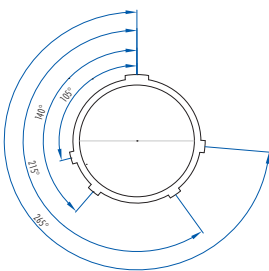

„Normal“ Type

Panel connector / Coupler connector / Female

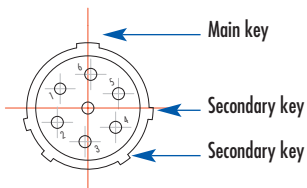

Type „02“

Panel connector / Coupler connector / Female

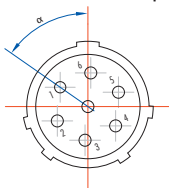

Rotation of the insert in relation to the „normal“ type

Keying type B:

Panel connector / Coupler connector

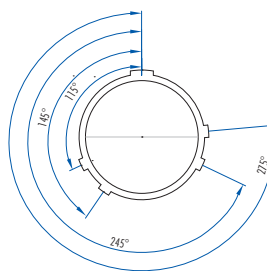

Type „03“

Panel connector / Coupler connector / Female

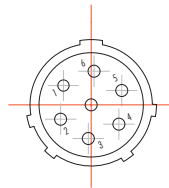

Main key identical to the „normal“ type, angular offset of the secondary keys

Type „04“

Panel connector / Coupler connector / Female

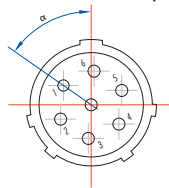

Rotation of the insert in relation to type „03“

$\alpha = 30^\circ$ for connectors with 7 and 19 contacts $\alpha = 45^\circ$ for connectors with 4 contacts $\alpha = 60^\circ$ for connectors with 3, 12 and 27 contacts

To order types „02“, „03“ or „04“, use the part numbers of our chosen „NORMAL“ type connector, modifying it according to the model below.

Model: Male panel connector, part number: 630 603 006 „NORMAL“ type

becomes 630 603 026 for a „02“ type

becomes 630 603 036 for a „03“ type

becomes 630 603 046 for a „04“ type

To facilitate identification of the connectors when wiring and locking, the barrels of the panel connector, coupler connector and the locking ring are identified by the number corresponding to the type of polarisation selected: type 02, 03 or 04.

N.B. The protective cap for the cable connector is different for keying type A and keying type B. Consult us.

Standard, Rapid and Weatherproof Series

These non-removable contacts are to be soldered

To avoid any error, the location of the contacts is identified by numbers on both sides of the panel connector, cable connector or coupler connector insert by numbers. For further information, refer to the „Contact arrangement“ document.

1. Remove the sheath from the cable over length B depending on the size of the housing (see table opposite).
2. Strip the wires over length A depending on the \varnothing of the contacts (see table opposite). Before soldering, insert the stripped part of the wire into the shaft of the contact and ensure it is fully inserted and that the wire insulation is applied against the rear of the contact.

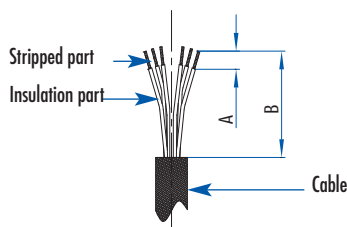

Housing	B: Sheath removed
1	25 mm
2	25 mm
3	25 mm
4	35 mm
5	35 mm

\varnothing Contact	A: Stripping length
2 mm	6 mm
3 mm	6 mm
4 mm	6 mm

Hermetic Series

These non-removable contacts are to be soldered

To avoid any error, the location of the contacts is identified by numbers on both sides of the panel connector and on both sides of the cable connector insert. For further information, refer to the „Contact arrangement“ document.

1. Remove the sheath from the cable over length B depending on the size of the housing of the panel connector and the cable connector (see table opposite).
2. Strip the wires over length A depending on the \varnothing of the contacts (see table opposite). Before soldering, insert the stripped part of the wire into the shaft of the contact. Check it is fully inserted via the vent hole, and that the wire insulation is applied against the rear of the contact.

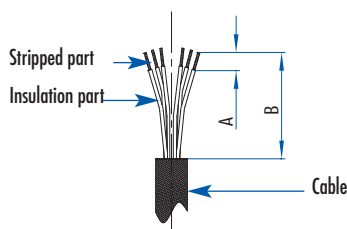

Housing	B: Sheath removed
1	25 mm
2	25 mm
3	25 mm
4	35 mm
5	35 mm

\varnothing Contact	A: Stripping length
2 mm	4,5 mm
3 mm	4,5 mm
4 mm	4,5 mm

Miniature, Atto and Natto Miniature Push-Pull, Industrial, Marine, Neptunox, Robotic and Minex Series

These contacts are either to be soldered or crimped

To avoid any error, the location of the contacts in the insert is identified by numbers.
For further information refer to the „Contact arrangement“ document

1. Remove the sheath from the cable over length „B“ depending on the size of the housing (see table opposite).
2. Strip the wires over length „A“ depending on the \varnothing of the contacts (see table opposite).
Before soldering, insert the stripped part of the wire into the shaft of the contact.
Check it is fully inserted via the vent hole, and that the wire insulation is applied against the rear of the contact.

Housing	B: Sheath removed
00	22 mm
0	25 mm
1	22 mm
2	27 mm
3	35 mm

\varnothing Contact	A: Stripping length
0,76 mm	4 mm
1 mm	4 mm
1,6 mm	6 mm
2,4 mm	6 mm

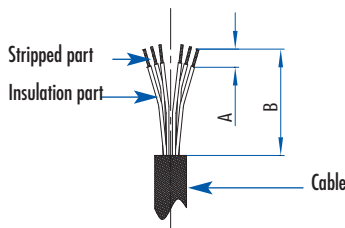

Power Series Puissance

These contacts are to be crimped

To avoid any error, the location of the contacts in the insert is identified by numbers.
For further information refer to the „Contact arrangement“ document

1. Remove the sheath from the cable over length „B“ depending on the size of the housing (see table opposite).
2. Wiring of „power“ conductors \varnothing 12mm or \varnothing 8mm:
 - a) fit the bushings of the contacts marked „B“ onto the wires L1, L2, making sure they are the right way round. (see diagram opposite).
 - b) Strip the wires L1, L2 over length „A“ depending on the \varnothing of the contacts (see table opposite).
Before crimping, insert the stripped part of the wire into the shaft of the contact.
Check it is fully inserted via the vent hole „Z“ and that the wire insulation is applied against the rear of the contact.

N.B. for cables of a smaller cross-section, remember to fit the reducer(s) in the contact shaft(s)

3. Wiring of „pilot“ conductors \varnothing 1,6mm:
 - a) fit the bushings of the contacts marked „C“ onto the wires 1 and 2, making sure they are the right way round. (see diagram opposite).
 - b) Strip the wires 1 and 2 over length A depending on the \varnothing of the contacts (see table opposite). Before crimping, insert the stripped part of the wire into the shaft of the contact. Check it is fully inserted via the vent hole „X“ and that the wire insulation is applied against the rear of the contact.

Housing	B: Sheath removed
5	80 mm

\varnothing Contact	A: Stripping length
12 mm	23 mm
8 mm	14 mm
1,6 mm	6 mm

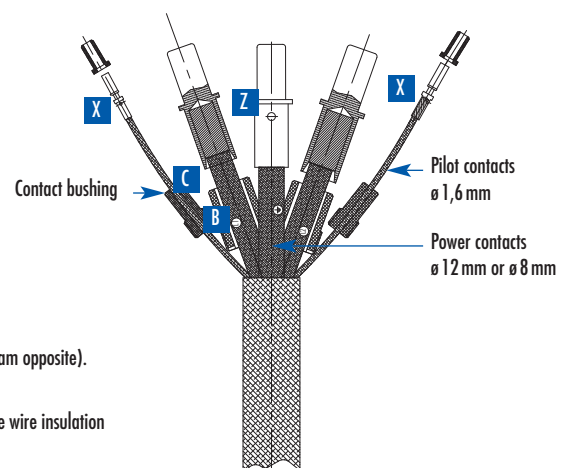

All series

Recommended equipment:

We recommend a HF iron to avoid thermal shock

A screwdriver type soldering iron tip 2,4 mm wide at the end and 15 mm long.

In accordance with the RoHS directive, we recommend lead-free soldering.

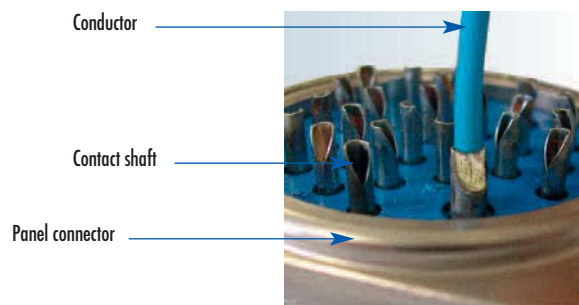

Contact soldering:

Important

To ensure the best possible solder, it is important to clean the tip before each operation using a damp sponge and carry out each operation quickly and accurately.

1.
Remove the sheath from the cable and then strip the wire. See explanation above.
Ensure that the strands of the wires in the stripped part are not separated.
2.
Tin the stripped part of the wire with a small amount of soldering material.
The solder metal must be evenly spread.
3.
The result must be smooth, shiny and covered with a thin film of flux (solder metal).
4.
To ensure heat transfer and stripping,
place a drop of solder metal on the end of the solder tip.
5.
Heat the contact shaft.
6.
Insert a sufficient amount of solder metal, but not too much, into the contact shaft.
7.
Insert the pre-tinned wire into the shaft of the contact, then remove the tip and allow the soldering to cool.
(the parts must remain immobile while cooling)

Warning

do not leave the solder tip on the shaft of the contact for too long or you may distort the insert



Atto and Natto Miniature Push-Pull, Miniature, Industrial, Marine, Robotic and Minex Series

Small crimp tool



Selection knob:

Adjust the depth of crimping on the contact according to the wire cross-section. To adjust the selector, refer to instruction number 4 of the „adjusting the large crimp tool“ part.



Information plate:

Gives all the information required to adjust the tool correctly.



Positioner: (unlocked position)

The positioner is designed for one contact \varnothing . To crimp a contact of different \varnothing , change the positioner.



Small crimp tool

Part numbers of the small crimp tool (Standard: M 22520-2/01 and M 22520-2/02)

\varnothing Contacts	Tool + Positioner	Tool	Positioner
\varnothing 0,76 mm	–	630 180 006	769 100 006
\varnothing 1 mm	579 316 006	630 180 006	630 181 006

Large crimp tool



Indexing mark

Selection knob:

Adjust the depth of the locator on the crimp tool according to the wire section



Information plate:

Gives all the information required to adjust the tool correctly

Marque d'indexation



Positioner: (unlocked position)

Identifies the \varnothing of the contact to be crimped



Trigger:

Unlocks the positioner

References of the large crimp tool (Standard: M 22520-1/01 and M 22520-1/02)

\varnothing Contacts	Tool + Positioner	Tool	Positioner
\varnothing 1 mm	579 481 006	630 190 006	630 191 006
\varnothing 1,6 mm	579 481 006	630 190 006	630 191 006
\varnothing 2,4 mm	579 481 006	630 190 006	630 191 006



Large crimp tool

Adjusting the large crimp tool:



Press the trigger to unlock the positioner.



Turn the positioner to bring the chosen colour opposite the indexing mark. (To know which colour to chose, use the table opposite or the information plate on the crimp tool.)



Press on the positioner to lock your choice.



Remove the safety pin. Lift the selector knob and turn it to bring the selected number opposite the indexing mark. (To know which number to choose, use the table opposite or the information plate on the crimp tool.)



Refit the safety pin.

Important: To adjust the positioner and the crimp tool selection knob, it must be in the open position.

Repeat the operation each time the \varnothing of the wire or the contact changes.

Crimping a contact:



After removing the sheath from the cable and stripping the wires (refer to the „stripping the contacts“ part) and adjusting the crimp tool (refer to the „adjusting the crimp tool“ part), insert the stripped part of the wire into the shaft of a contact. Ensure that it is fully inserted using the vent hole. Fully open the crimp tool. Fully insert the contact and wire assembly into the orifice on the back of the tool.



Then crimp by closing the two arms of the tool completely until it reopens again. Check by looking that the contact is correctly crimped: the wire must be visible through the vent hole and the insulation on the wire must be applied against the rear of the contact.

Instruction table

ø Contacts	Wire		Large crimp tool		Small crimp tool
	AWG	Cross section in mm ²	Positioner: Colours index	Position of the selection knob	Position of the selection knob
ø 0,76 mm	26	0,15	–		3
ø 0,76 mm	24	0,21 – 0,24	–		4
ø 0,76 mm	22	0,34 – 0,38	–		5
ø 1 mm	26	0,15	Red	1	4
ø 1 mm	24	0,21 – 0,24	Red	2	5
ø 1 mm	22	0,34 – 0,38	Red	3	6
ø 1 mm	20	0,6	Red	4	7
ø 1 mm	18	0,93	Red	5	8
ø 1,6 mm	20	0,6	Blue	4	
ø 1,6 mm	18	0,93	Blue	5	
ø 1,6 mm	16	1,23 – 1,34	Blue	6	
ø 1,6 mm	14	1,82 – 1,93	Blue	7	
ø 2,4 mm	16	1,23 – 1,34	Yellow	6	
ø 2,4 mm	14	1,82 – 1,93	Yellow	7	
ø 2,4 mm	12	2,98 – 3,18	Yellow	8	

Power Series Puissance

Crimp tools

∅ Crimp tool without hexagonal die	Hexagonal die WG	∅ Contact	Cross section	Wire max. sheath ∅	Stripping
809 835 006	809 908 006	8 mm	16 mm ²	7 mm	14 mm
809 835 006	809 908 006	8 mm	25 mm ²	7 mm	14 mm
809 835 006	809 909 006	8 mm	35 mm ²	9,3 mm	14 mm
809 875 006	809 912 006	12 mm	70 mm ²	13,8 mm	23 mm
809 875 006	809 912 006	12 mm	95 mm ²	13,8 mm	23 mm

∅ 8 mm, ∅ 12 mm



∅ Contacts	Wire		Large crimp tool 579 481 006	
	USA rating AWG	Cross-section in mm ²	Positioner: Colours index	Position of the selection knob
∅ 1,6 mm	20	0,6	blue	4
∅ 1,6 mm	18	0,93	blue	5
∅ 1,6 mm	16	1,23 – 1,34	blue	6
∅ 1,6 mm	14	1,82 – 1,93	blue	7

∅ 1,6 mm



Reference of the large crimp tool

∅ Contacts	Tool + Positioner	Tool	Positioner
∅ 1 mm	579 481 006	630 190 006	630 191 006
∅ 1,6 mm	579 481 006	630 190 006	630 191 006
∅ 2,4 mm	579 481 006	630 190 006	630 191 006

Reducers

Pack of 3 reducers	25 mm ² → 16 mm ²	860 250 006
Pack of 9 reducers	35 mm ² classe 6 → 35 mm ² classe 5	849 606 006
Pack of 1 reducer	95 mm ² → 70 mm ²	849 603 006



Tool for fitting and removing contacts

∅ Contacts	Part Numbers
1,6 mm	806 903 006
8 mm	806 903 006
12 mm	896 903 006



End for screwing the bushing to fit the ∅ 8 mm contacts.



End for screwing the bushing to fit the ∅ 1,6 mm contacts.

End for screwing the bushing to fit the ∅ 12 mm contacts.

Fitting the contacts

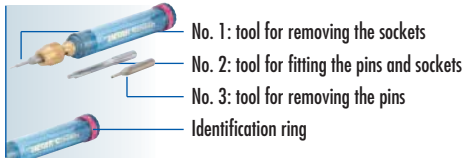

Tool for fitting and removing contacts

Part numbers of tools for fitting and removing contacts

Ø Contacts	Part Number	Identification ring
Ø 0,76 mm	769 131 006	White
Ø 1 mm	597 104 006	Red
Ø 1,6 mm	577 454 006	Blue
Ø 2,4 mm	577 458 006	Yellow
MINEX	597 104 106	
17 mixed contacts	597 104 206	



Fitting the contacts

1. Fit blade No. 2 in the handle of the tool



2. Position the wire and the contact in the channel on this blade. Insert the assembly from the rear of the panel connector or the cable connector, starting from the centre of the insert and working towards the outside, in the slot intended for the contact, according to your wiring diagram. Push the blade in as far as it will go. Withdraw the blade. Check that the contacts are correctly fitted by gently pulling on each wire.



Removing the contacts

3. Position blade No. 1 or No. 3 from the front of the panel connector or the cable connector in line with the socket or the pin depending on the blade used. Then exert axial pressure until the pin or the socket is released from the insert.

Numerical Index – Technical guides

Part No.	Series	Designation	Page
577 454 006	Wiring	Tool for assembly and disassembly of contacts	171
577 458 006	Wiring	Tool for assembly and disassembly of contacts	171
579 316 006	Wiring	Crimp tool + positioner	170
579 481 006	Wiring	Crimp tool + positioner	170
597 104 006	Wiring	Tool for assembly and disassembly of contacts	171
597 104 106	Wiring	Tool for assembly and disassembly of contacts	171
597 104 206	Wiring	Tool for assembly and disassembly of contacts	171
630 190 006	Wiring	Crimp tool	170
630 191 006	Wiring	Positioner Ø 1 mm – 1,6 mm – 2,4 mm	170
680 180 006	Wiring	Crimp tool	170
680 181 006	Wiring	Positioner Ø 1 mm	170
769 100 006	Wiring	Positioner Ø 0,76 mm	170
769 131 006	Wiring	Tool for assembly and disassembly of contacts	171
806 903 006	Wiring	Tool for assembly and disassembly of contacts	172
809 835 006	Wiring	Crimp tool	172

Part No.	Series	Designation	Page
809 875 006	Wiring	Crimp tool	172
809 908 006	Wiring	Die	172
809 909 006	Wiring	Die	172
809 912 006	Wiring	Die	172
849 603 006	Wiring	Reducers	172
849 606 006	Wiring	Reducers	172
860 250 006	Wiring	Reducers	172
896 903 006	Wiring	Tool for assembly and disassembly of contacts	172

Notes

Ruled area for taking notes, consisting of a dark blue header 'Notes' and a large white area with horizontal lines.

Connectors with non-removable contacts

Connectors with removable contacts

Accessories

Technical guides

www.jaegerconnecteurs.com

JAEGER Connecteurs

ZI Rue de L'Acqueline
51800 Sainte Ménehould
France
www.jaegerconnecteurs.com

Tel. +33 03 26 60 58 10
Fax +33 03 26 60 58 12
E-Mail info@jaegerconnecteurs.com

**JAEGER
CONNECTEURS**