



Fittings

FITTINGS

Parkrimp (crimp) Series

Field Attachable Series

Visit www.parkerhose.com for 3D CAD drawings.



NPTF

Seal-Lok[®]

Parkrimp (crimp) Series of Fittings

25 Series	B-5
26 Series	B-9
43 Series	B-27
70 Series	B-57
71 Series	B-67
73 Series	B-81
76 Series	B-90
78 Series	B-92
S6 Series	B-93
79 Series	B-105
HY Series	B-110
81 Series	B-181

Field Attachable Series of Fittings

20 Series	B-125
21 Series	B-135
22 Series	B-143
23 Series	B-147
30 Series	B-151
42 Series	B-157
82 Series	B-164
88 Series	B-181
TB Series	B-187

Hose
A

Fittings
B

Equipment
C

Accessories
D

Technical
E

How to Read the Fittings Section

With more than 750 end configurations, Parker's brass, stainless steel and Chromium-6 free plated steel fittings include O-ring face seal, flare, straight thread, pipe and metric designs, in both crimp and field attachable styles. (Along with Parker hose, all fittings have been tested and approved, and meet stringent industry standards worldwide.) Fitting page content is defined by the information shown below. Please take a moment and review.

How to Select Parkrimp Hose Fittings

- Example: 1JC43-12-8C
- 1**JC43-12-8C - Fitting (1=Crimp, 2=Field attachable, 3=Push-Lok, Blank=Nipple with clamp)
 - 1****J**C43-12-8C - End Connection
 - 1**J**C**43**-12-8C - Fitting Series
 - 1JC43-**12**-8C - Size of Fitting End Connection
 - 1JC43-12-**8**C - Hose Size
 - 1JC43-12-8**C** - Fitting Material
 - No Suffix = Steel
 - B = Brass
 - C = 316 Stainless Steel
 - BA = Brass Nipple with Steel Nut and Socket
 - BS = Brass Nipple with Brass nut and Socket
 - SM = Metric Index

Hose Inner Diameter
Measured in 1/16 inch increments identified by use of a "dash"(-) numbering system. i.e., 4/16" = 1/4" = -4.

"A" Dimension Overall Length

Hex size
Use to determine the wrench size

"B" Dimension
(Cutoff Allowance) Dimension used to determine cut length (C.L.) of hose when making a hose assembly

Catalog 4400 US
Pipe / JIC

26 Series Fittings
Use with 201, 206, 213, 221FR, 225, 244, 266, 265, 293, SS23CG hoses.

10126
Male NPTF Pipe - Rigid - Straight

Lists approved hoses for fitting series

Standard material for fittings is steel. For additional material, refer to column

# Part Number	Thread inch	Hose I.D. inch	A		H		B		Additional Material Brass
			inch	mm	inch	mm	inch	mm	
10126-2-4	1/8x27	3/16	1.65	42	7/16	0.78	0.78	20	
10126-4-4	1/4x18	3/16	1.88	48	9/16	1.01	1.01	26	
10126-4-5	1/4x18	1/4	1.88	48	9/16	1.01	1.01	26	
10126-4-6	1/4x18	5/16	1.88	48	3/4	1.02	1.02	26	•
10126-6-6	3/8x18	5/16	1.89	48	11/16	1.03	1.03	26	•
10126-6-8	3/8x18	13/32	1.89	48	11/16	1.03	1.03	26	•
10126-8-8	1/2x14	13/32	2.14	54	7/8	1.28	1.28	33	•
10126-8-10	1/2x14	1/2	2.25	57	7/8	1.30	1.30	33	•
10126-12-12	3/4x14	5/8	2.31	59	1-1/16	1.37	1.37	35	•
10126-16-16	1x11-1/2	7/8	2.61	66	1-3/8	1.57	1.57	40	
10126-20-20	1-1/4x11-1/2	1-1/8	2.83	72	1-3/4	1.77	1.77	45	
10126-24-24	1-1/2x11-1/2	1-3/8	3.01	76	2	1.93	1.93	49	
10126-32-32	2x11-1/2	1-13/16	3.44	87	2-1/2	2.18	2.18	55	

Indicates Fitting Section

Continued on next page



Hose
A

Fittings
B

Equipment
C

Accessories
D

Technical
E

How to Read the Fittings Section

Continued from previous page

How to Select Parkrimp Hose Fittings

Example: 1JC43-12-8C

- 1JC43-12-8C - Fitting (1 = Crimp, 2 = Field Attachable, 3 = Push-Lok, Blank = Nipple with clamp or shell)
- 1 C43-12-8C - End connection (In this case, a female Seal-Lok – swivel – straight)
- 1JC -12-8C - Fitting series
- 1JC43- -8C - Size of fitting end connection (In this case, 12/16" or 3/4")
- 1JC43-12- C - Hose size (In this case, 8/16" or 1/2")
- 1JC43-12-8C - Fitting material:

- No Suffix = Steel
- B = Brass
- C = 316 Stainless Steel
- BA = Brass Nipple with Steel Nut and Socket
- BS = Brass Nipple with Brass Nut and Socket
- SM = Metric Hex



How to Select Two-Piece Field Attachable Fittings

When selecting a two-piece field attachable fitting, the fitting part number (found in Section B of this catalog) needs to be broken down into two distinct numbers for the nipple and the socket.

Example: 20120-16-16B

Socket Part Number

Example: 20020-16B

- 20020-16B - Fitting (1 = Crimp, 2 = Field Attachable, 3 = Push-Lok, Blank = Nipple with clamp or shell)
- 20020-16B - End connection ("00" represents that it is a socket)
- 20020-16B - Fitting series
- 20020-16B - Hose size (In this case, 16/16" or 1")
- 20020-16B - Fitting material:

- No Suffix = Steel
- B = Brass
- C = 316 Stainless Steel
- BA = Brass Nipple with Steel Nut and Socket
- BS = Brass Nipple with Brass Nut and Socket
- SM = Metric Index



Nipple Part Number

Example: 0120-16-16B

- _0120-16-16B - Fitting (1 = Crimp, 2 = Field Attachable, 3 = Push-Lok, Blank = Nipple with clamp or shell)
- 0120-16-16B - End connection (In this case, a male NPTF Pipe – rigid – straight)
- 0120-16-16B - Fitting series
- 0120-16-16B - Size of fitting end connection (In this case, 16/16" or 1")
- 0120-16-16B - Hose size (In this case, 16/16" or 1")
- 0120-16-16B - Fitting material:

- No Suffix = Steel
- B = Brass
- C = 316 Stainless Steel
- BA = Brass Nipple with Steel Nut and Socket
- BS = Brass Nipple with Brass Nut and Socket
- SM = Metric Index



Hose
A

Fittings
B

Equipment
C

Accessories
D

Technical
E

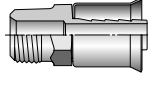
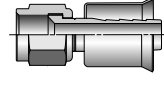
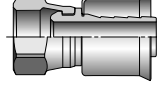
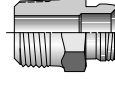
 <p>Flange</p>	<p>10125 B-6</p>  <p>Rigid</p>	<p>10825 B-6</p>  <p>Swivel</p>	<p>17B25 B-6</p>  <p>Swivel</p>	<p>017M B-6</p>  <p>Swivel</p>	<p>B-7</p> <p>Assembly Instructions</p>
---	---	--	---	---	---

Hose
A

Fittings
25 Series
B

Equipment
C

Accessories
D

Technical
E

Hose
A
Fittings
25 Series
B
Equipment
C
Accessories
D
Technical
E

10125

Male NPTF Pipe - Rigid

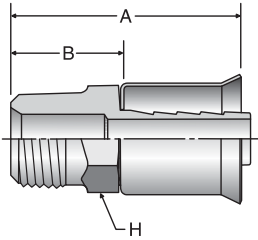

# Part Number	Thread inch	Hose I.D. inch	A		H inch	B	
			inch	mm		inch	mm
10125-6-6B-VS	3/8X18	3/8	1.72	44	11/16	1.00	25
10125-6-8B-VS	3/8X18	1/2	1.72	44	11/16	1.00	25
10125-8-6B-VS	1/2X14	3/8	2.05	52	7/8	1.33	34
10125-8-8B-VS	1/2X14	1/2	2.05	52	7/8	1.33	34

10825

Female SAE 45° - Swivel

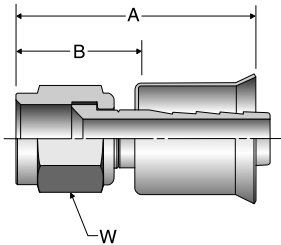

# Part Number	Thread inch	Hose I.D. inch	A		H inch	B	
			inch	mm		inch	mm
10825-6-6B	5/8X18	3/8	1.82	46	3/4	1.10	28
10825-6-8B	3/4X16	3/8	1.80	46	7/8	1.08	27
10825-8-8B	3/4X16	1/2	1.95	50	7/8	1.22	31

17B25

Female Air Brake Jounce Line - Swivel - Straight

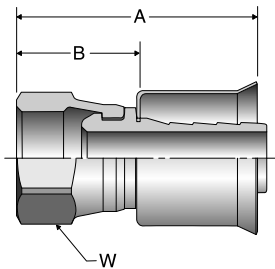

# Part Number	Thread inch	Hose I.D. inch	A		H inch	B	
			inch	mm		inch	mm
17B25-8-6B	3/4X20	3/8	1.59	40	7/8	0.87	22
17B25-8-8B	3/4X20	1/2	1.59	40	7/8	0.87	22

017M

Air Brake Adapter

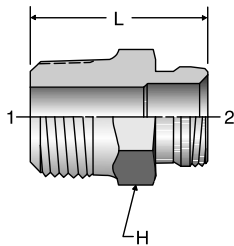

# Part Number	Thread End 1 NPTF inch		Thread End 2 UNEFinch		L		H inch
	inch	mm	inch	mm	inch	mm	
017M-6-8B	6	3/8X18	8	3/4X20	1.13	29	3/4
017M-8-8B	8	1/2X14	8	3/4X20	1.33	34	7/8

Assembly Instructions

1. On the 08 end configurations only, the use of a mandrel is required. This mandrel is designed to set the proper gap between the nut and the shell. To match the correct fitting with the proper mandrel part number refer to the table below.



2. The assembly mandrels can be used with a common bench vise or on the TH2-7 push-on stand. Refer to Bulletin 4480-T13-USA for push-on stand instructions.
3. When using a common bench vise, place the mandrel in the vise, put the fitting on the mandrel (nut first) then push on the hose until it bottoms. Visually check the sight hole on the side of the shell to assure that the hose is fully inserted.
4. Remove mandrel from fitting and check for proper gap between nut and shell. (See table below).
5. Now crimp the fitting onto the hose. Refer to CrimpSource for correct crimp dies and crimping dimensions.
6. Check for proper gap between nut and shell after crimp. (See table below)

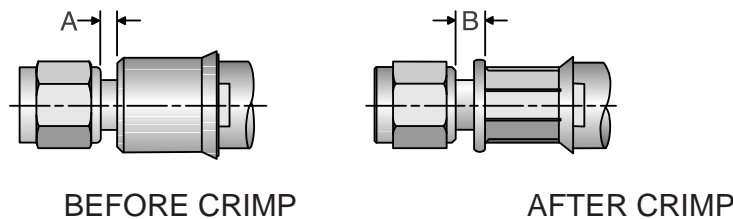

NOTE: B dimension is measured from the back of the fully-seated nut to the start of the crimp length. The nut must be free to swivel after crimping of the shell.

Fitting Part Number	A Length		B Length		Required Assembly Mandrel
	mm	inch	mm	inch	
10825-6-6B	3,805,85	0.1500.230	8,0011,80	0.3150.465	TH2-7M25-6
10825-8-8B	3,805,85	0.1500.230	8,0011,80	0.3150.465	TH2-7M25-8

7. For all other 25 series fittings, use of mandrel is not necessary. Push fitting onto hose until it bottoms. Visually check sight hole on the side of the shell to assure that the hose is fully inserted.

Hose
A









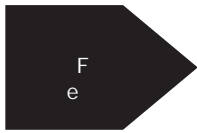
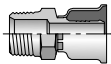

Fittings
25 Series
B

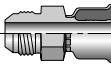
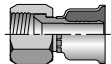
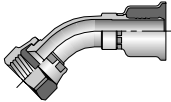
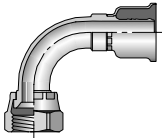
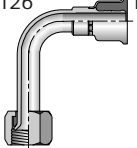
Equipment
C

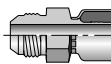
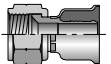
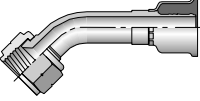
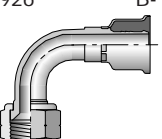
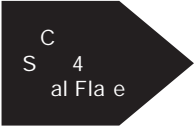
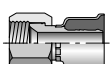
Accessories
D

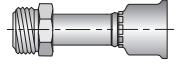
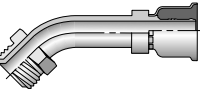
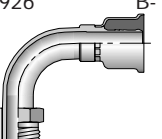
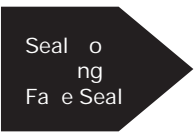
Technical
E

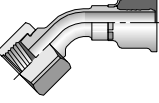
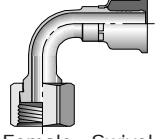
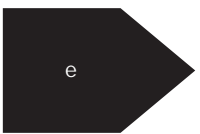
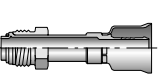
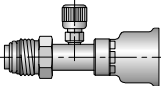
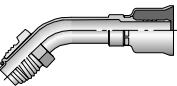
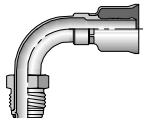
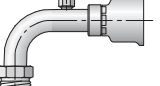
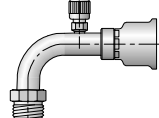
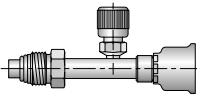
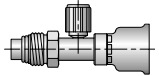
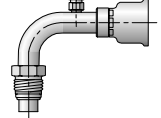
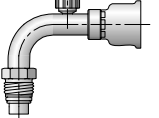

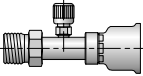
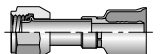
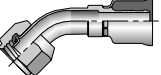
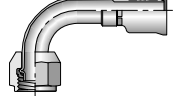
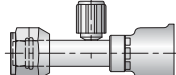
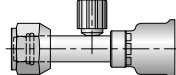
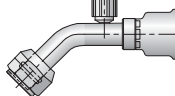
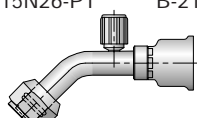
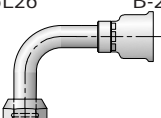
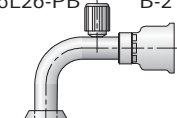
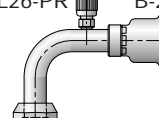
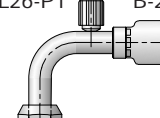
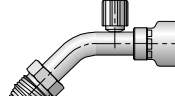
	10126 B-11  Male - Rigid		10326 B-11  Male - Rigid	10626 B-12  Female - Swivel	13726 B-12  Female - Swivel 45° Elbow - Short
13926 B-12  Female - Swivel 90° Elbow - Short	14126 B-13  Female - Swivel 90° Elbow - Long		10426 B-13  Male - Rigid	10826 B-13  Female - Swivel	17726 B-13  Female - Swivel 45° Elbow
17926 B-14  Female - Swivel 90° Elbow		16826 B-14  Female - Swivel		12826 B-14  Male - Swivel	16726 B-15  Male - Swivel 45° Elbow
16926 B-15  Male - Swivel 90° Elbow		1JC26 B-15  Female - Swivel Short	1J726 B-16  Female - Swivel 45° Elbow	1J926 B-16  Female - Swivel 90° Elbow - Short	
1S526 B-16  Male - Swivel Short Pilot	1S526-PR B-17  Male - Swivel Short Pilot	15R26 B-17  Male - Swivel 45° Elbow - Short Pilot	15K26 B-17  Male - Swivel 90° Elbow - Short Pilot	15K26-PB B-17  Male - Swivel 90° Elbow - Short Pilot	15K26-PR B-18  Male - Swivel 90° Elbow - Short Pilot
14526-PR B-18  Male - Swivel Long Pilot	14526-PT B-18  Male - Swivel Long Pilot	15M26-PR B-18  Male - Swivel 90° Elbow - Long Pilot	15M26-PT B-19  Male - Swivel 90° Elbow - Long Pilot	15G26 B-19  Male - Rigid Internal - Long Pilot	15G26-PR B-19  Male - Rigid Internal - Long Pilot
15S26 B-19  Female - Swivel Short Pilot	15H26 B-20  Female - Swivel 45° Elbow - Short Pilot	15T26 B-20  Female - Swivel 90° Elbow - Short Pilot	15926-PB B-20  Female - Swivel Long Pilot	15926-PT B-20  Female - Swivel Long Pilot	15N26-PB B-21  Female - Swivel 45° Elbow - Long Pilot
15N26-PT B-21  Female - Swivel 45° Elbow - Long Pilot	15L26 B-21  Female - Swivel 90° Elbow - Long Pilot	15L26-PB B-21  Female - Swivel 90° Elbow - Long Pilot	15L26-PR B-22  Female - Swivel 90° Elbow - Long Pilot	15L26-PT B-22  Female - Swivel 90° Elbow - Long Pilot	15P26-PT B-22  Male - Swivel 45° Elbow - Long Pilot

Hose

A

Fittings
26 Series

B

Equipment

C

Accessories

D

Technical

E





Hose
A

Fittings
26 Series
B

Equipment
C

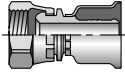
Accessories
D

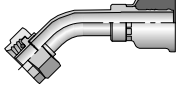
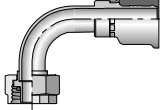
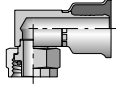
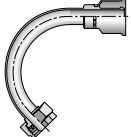
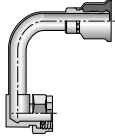
Technical
E

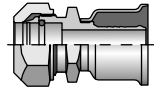
	<p>17B26 B-22</p>  <p>female Swivel</p>		<p>15V26 B-23</p>  <p>female Swivel Elbow</p>	<p>15W26 B-23</p>  <p>female Swivel Elbow</p>	<p>15 26 B-23</p>  <p>female Swivel Elbow Loc Type</p>
<p>1RV26 B-23</p>  <p>female Swivel Elbow</p>	<p>1R 26 B-24</p>  <p>female Swivel Elbow</p>		<p>1T126 B-24</p>  <p>female w/Nut Ferrule</p>	<p>1T126 B-25</p> <p>Fitting Assembly Instructions</p>	

10126

Male NPTF Pipe - Rigid

# Part Number	Thread		Hose I.D. inch	A		H		B		Additional Material Brass (B)
	inch			inch	mm	inch	mm	inch	mm	
10126-2-4	1/8x27		3/16	1.65	42	7/16	0.78	0.78	20	
10126-4-4	1/4x18		3/16	1.88	48	9/16	1.01	1.01	26	
10126-4-5	1/4x18		1/4	1.88	48	9/16	1.01	1.01	26	
10126-4-6	1/4x18		5/16	1.88	48	3/4	1.02	1.02	26	
10126-6-6	3/8x18		5/16	1.89	48	11/16	1.03	1.03	26	
10126-6-8	3/8x18		13/32	1.89	48	11/16	1.03	1.03	26	
10126-8-8	1/2x14		13/32	2.14	54	7/8	1.28	1.28	33	
10126-8-10	1/2x14		1/2	2.25	57	7/8	1.30	1.30	33	
10126-12-12	3/4x14		5/8	2.31	59	1-1/16	1.37	1.37	35	
10126-16-16	1x11-1/2		7/8	2.61	66	1-3/8	1.57	1.57	40	
10126-20-20	1-1/4x11-1/2		1-1/8	2.83	72	1-3/4	1.77	1.77	45	
10126-24-24	1-1/2x11-1/2		1-3/8	3.01	76	2	1.93	1.93	49	
10126-32-32	2x11-1/2		1-13/16	3.44	87	2-1/2	2.18	2.18	55	

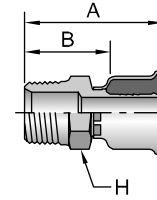

10326

Male JIC 37 - Rigid

# Part Number	Thread		Hose I.D. inch	A		H		B		Additional Material Brass (B)
	inch			inch	mm	inch	mm	inch	mm	
10326-4-4	1/4	7/16x20	3/16	2.02	50	1/2	1.15	1.15	29	
10326-6-6	3/8	9/16x18	5/16	2.12	54	3/4	1.26	1.26	32	
10326-8-8	1/2	3/4X16	13/32	1.94	49	13/16	1.08	1.08	27	
10326-10-10	5/8	7/8X14	1/2	2.49	64	15/16	1.54	1.54	39	
10326-16-16	1	1-5/16x12	7/8	2.79	71	1-3/8	1.75	1.75	44	

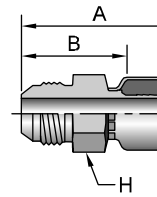

Hose

A

Fittings
26 Series

B

Equipment

C

Accessories

D

Technical

E

Hose
A

10626

Female JIC 37 - Swivel

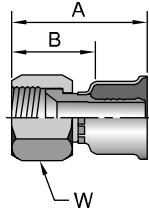

# Part Number	Thread		Hose I.D. inch	A		B		Additional Material Brass (B)
	inch	inch		inch	mm	inch	mm	
10626-6-6	3/8	9/16x18	5/16	1.81	45	11/16	0.95	23
10626-6-8	3/8	9/16x18	13/32	1.67	52	11/16	1.19	30
10626-12-12	3/4	1-1/16x12	5/8	2.29	58	1-1/4	1.35	34
10626-16-16	1	1-5/16x12	7/8	2.53	64	1-1/2	1.49	38
10626-20-20	1-1/4	1-5/8x12	1-1/8	2.56	65	2	1.50	38
10626-24-24	1-1/2	1-7/8x12	1-3/8	2.77	70	2-1/4	1.69	43
10626-32-32	2	2-1/2x12	1-13/16	3.30	84	2-7/8	2.04	52

Fittings
26 Series
B

13726

Female JIC 37 - Swivel - 45° Elbow - Short Drop

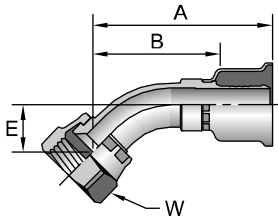

# Part Number	Thread		Hose I.D. inch	A		E		B		
	inch	inch		inch	mm	inch	mm	inch	mm	
13726-4-4	1/4	7/16x20	3/16	2.01	51	0.39	10	9/16	1.14	29
13726-6-6	3/8	9/16x18	5/16	2.72	69	0.43	11	11/16	1.86	47
13726-8-8	1/2	3/4x16	13/32	2.82	72	0.55	14	7/8	1.96	50
13726-10-10	5/8	7/8x14	1/2	2.96	75	0.63	16	1	2.01	51
13726-12-12	3/4	1-1/16x12	5/8	3.44	87	0.83	21	1-1/4	2.50	63
13726-16-16	1	1-5/16x12	7/8	3.34	85	0.90	23	1-1/2	2.30	58
13726-20-20	1-1/4	1-5/8x12	1-1/8	3.74	95	1.18	30	2	2.68	68
13726-24-24	1-1/2	1-7/8x12	1-3/8	3.92	100	1.16	29	2-1/4	2.84	72

Equipment
C

13 26

Female JIC 37 - Swivel - 0° Elbow - Short Drop

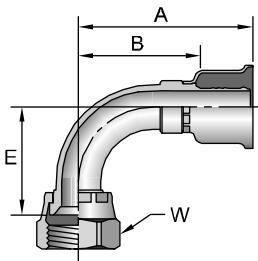

# Part Number	Thread		Hose I.D. inch	A		E		B		
	inch	inch		inch	mm	inch	mm	inch	mm	
13926-4-4	1/4	7/16x20	3/16	1.82	46	0.83	21	9/16	0.95	24
13926-6-6	3/8	9/16x18	5/16	2.15	55	0.91	23	11/16	1.29	33
13926-8-8	1/2	3/4x16	13/32	2.22	56	1.09	28	7/8	1.36	35
13926-10-10	5/8	7/8x14	1/2	2.23	57	1.26	32	1	1.28	33
13926-10-12	5/8	7/8x14	5/8	2.52	64	1.23	31	1	1.58	40
13926-12-12	3/4	1-1/16x12	5/8	2.28	58	1.82	46	1-1/4	1.30	34
13926-16-16	1	1-5/16x12	7/8	3.30	84	2.14	54	1-1/2	2.26	57
13926-20-20	1-1/4	1-5/8x12	1-1/8	3.60	91	2.57	65	2	2.53	65
13926-24-24	1-1/2	1-7/8x12	1-3/8	3.92	100	2.82	72	2-1/4	2.84	72

Accessories
D

Technical
E

14126

Female JIC 37° - Swivel - 0° Elbow - Long Drop

# Part Number	Thread		Hose I.D. inch	A		E		B		
	inch	inch		inch	mm	inch	mm	inch	inch	mm
14126-4-4	1/4	7/16x20	1/4	2.05	52	1.81	46	9/16	1.18	30
14126-6-6	3/8	9/16x18	5/16	2.02	51	2.13	54	11/16	1.16	29
14126-8-8	1/2	3/4x16	13/32	2.35	60	2.43	62	7/8	1.49	38
14126-10-10	5/8	7/8x14	1/2	2.11	54	2.76	70	1	1.16	29
14126-16-16	1	1-5/16x12	7/8	3.17	81	4.33	110	1-1/2	2.13	54

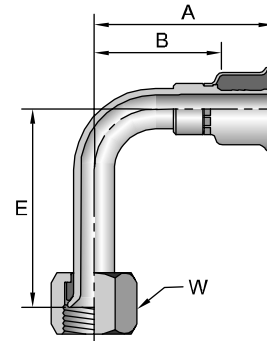

10426

Male SAE 45° - Rigid

# Part Number	Thread		Hose I.D. inch	A		H inch	B	
	inch	inch		inch	mm		inch	mm
10426-4-4	1/4	7/16x20	3/16	1.97	50	1/2	1.18	28
10426-6-6	3/8	5/8x18	5/16	2.04	52	11/16	1.18	30

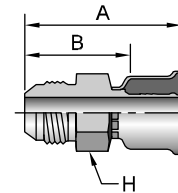

10826

Female SAE 45° - Swivel

# Part Number	Thread		Hose I.D. inch	A		H inch	B		Additional Material Brass (B)
	inch	inch		inch	mm		inch	mm	
10826-6-6	3/8	5/8x18	5/16	1.84	47	3/4	0.98	25	
10826-10-8	5/8	7/8x14	13/32	2.21	56	1	1.35	34	
10826-10-10	5/8	7/8x14	1/2	2.13	54	1	1.18	30	
10826-12-12	3/4	1-1/16x14	5/8	2.19	56	1-1/4	1.25	32	

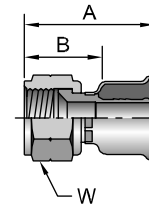

17726

Female SAE 45° - Swivel - 45° Elbow

# Part Number	Thread		Hose I.D. inch	A		E		B		
	inch	inch		inch	mm	inch	mm	inch	inch	mm
17726-4-4	1/4	7/16x20	3/16	2.29	58	0.39	10	9/16	1.43	36
17726-6-6	3/8	5/8x18	5/16	2.72	69	0.43	11	11/16	1.86	47
17726-8-8	1/2	3/4x16	13/32	2.82	72	0.59	14	7/8	1.96	50
17726-10-10	5/8	7/8x14	1/2	2.96	75	0.63	16	1	2.01	51
17726-12-12	3/4	1-1/16x14	5/8	3.43	87	0.83	21	1-1/4	2.49	63

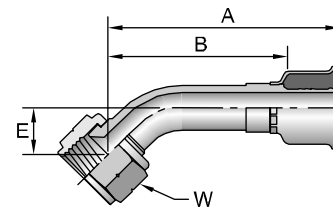

Notch on nut signifies SAE 45° flare fitting.

Hose
A

Fittings
26 Series
B

Equipment
C

Accessories
D

Technical
E

17 26 Female SAE 45 - Swivel - 0 Elbow

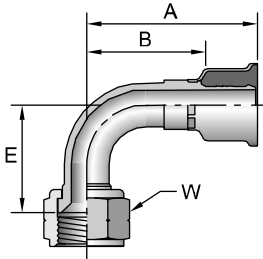

# Part Number	Thread		Hose I.D. inch	A		E		inch	B	
	inch	inch		inch	mm	inch	mm		inch	mm
17926-4-4	1/4	7/16x20	3/16	1.75	44	0.83	21	9/16	0.89	23
17926-6-6	3/8	5/8x18	5/16	2.15	55	0.91	23	3/4	1.29	33
17926-8-8	1/2	3/4x16	13/32	2.31	58.7	1.00	25.4	7/8	1.45	37
17926-10-10	5/8	7/8x14	1/2	2.23	57	1.26	32	1	1.28	33
17926-12-12	3/4	1-1/16x14	5/8	2.28	58	1.82	46	1-1/4	1.34	34

Notch on nut signifies 45 flare fitting.

16826 Female JIC 37 SAE 45 - Dual Flare - Swivel

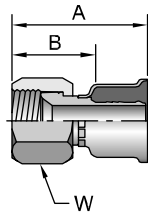

# Part Number	Thread		Hose I.D. inch	A		inch	B		Additional Material Brass (B)
	inch	inch		inch	mm		inch	mm	
16826-4-4	1/4	7/16x20	3/16	1.67	42	9/16	0.80	20	
16826-4-5	1/4	7/16x20	1/4	1.55	48	9/16	1.03	26	
16826-4-6	1/4	7/16x20	5/16	1.55	39	9/16	0.07	17	
16826-5-5	5/16	1/2x20	1/4	1.77	45	5/8	0.90	23	
16826-8-6	1/2	3/4x16	5/16	1.76	56	7/8	1.34	34	
16826-8-8	1/2	3/4x16	13/32	1.91	49	7/8	1.05	27	
16826-8-10	1/2	3/4x16	1/2	2.36	60	7/8	1.41	36	
16826-10-10	5/8	7/8x14	1/2	2.17	55	1	1.23	31	
16826-10-12	5/8	7/8x14	5/8	1.96	61	1	1.53	37	

12826 Male Inverted SAE 45 - Swivel

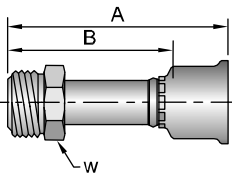

# Part Number	Thread		Hose I.D. inch	A		inch	B	
	inch	inch		inch	mm		inch	mm
12826-4-4	1/4	7/16x24	3/16	2.43	62	7/16	1.56	40
12826-5-5	5/16	1/2x20	1/4	2.56	65	1/2	1.69	43
12826-6-6	3/8	5/8x18	5/16	2.87	73	5/8	2.01	51
12826-8-8	1/2	3/4x18	13/32	3.00	76	3/4	2.14	54
12826-10-10	5/8	7/8x18	1/2	3.17	81	7/8	2.22	56

See Accessories Section for O-Rings and Flange its.



16726

Male Inverted SAE 45 - Swivel - 45 Elbow

# Part Number	Thread		Hose I.D. inch	A		E		B		
	inch	mm		inch	mm	inch	mm	inch	mm	
16726-4-4	1/4	7/16x24	3/16	2.20	56	0.63	16	7/16	1.33	34
16726-5-5	5/16	1/2x20	1/4	2.30	58	0.70	18	1/2	1.43	36
16726-6-6	3/8	5/8x18	5/16	2.55	65	0.87	22	5/8	1.69	43
16726-8-8	1/2	3/4x18	13/32	2.60	66	1.09	28	3/4	1.74	44

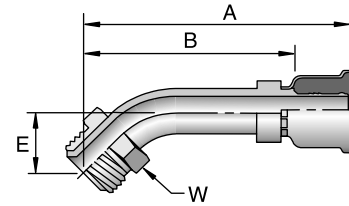

16 26

Male Inverted SAE 45 - Swivel - 90 Elbow

# Part Number	Thread		Hose I.D. inch	A		E		B		
	inch	mm		inch	mm	inch	mm	inch	mm	
16926-4-4	1/4	7/16x24	3/16	2.27	58	1.56	40	7/16	1.40	36
16926-6-6	3/8	5/8x18	5/16	1.89	48	1.48	38	5/8	1.03	26
16926-8-8	1/2	3/4x18	13/32	2.25	57	1.88	48	3/4	1.39	35
16926-10-10	5/8	7/8x18	1/2	2.70	69	2.17	55	7/8	1.75	44

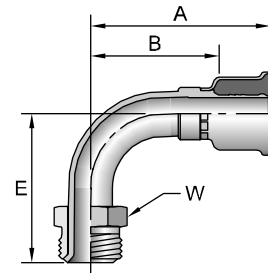

1JC26

Female Seal-Lok - Swivel - Short

# Part Number	Thread		Hose I.D. inch	A		C		H		B	
	inch	mm		inch	mm	inch	mm	inch	mm	inch	mm
1JC26-4-4	1/4	9/16x18	3/16	1.66	42	0.31	8	9/16	11/16	0.79	20
1JC26-6-6	3/8	11/16x16	5/16	1.70	43	0.34	9	11/16	13/16	0.84	21
1JC26-8-8	1/2	13/16x16	13/32	1.76	45	0.43	11	13/16	15/16	0.90	23
1JC26-12-12	3/4	1-3/16x12	5/8	2.13	54	0.55	14	1-1/8	1-3/8	1.19	30
1JC26-16-16	1	1-7/16x12	7/8	2.39	61	0.56	14	1-3/8	1-5/8	1.35	34
1JC26-20-20	1-1/4	1-11/16x12	1-1/8	2.45	62	0.59	15	1-7/8	1-7/8	1.39	35

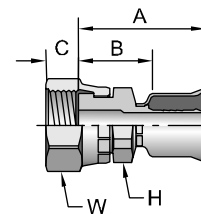

When measuring overall length to the end of the nut, B + C must be used to calculate cut-off allowance.
See Accessories Section for O-Rings.

Hose
A

Fittings
26 Series
B

Equipment
C

Accessories
D

Technical
E

Hose
A

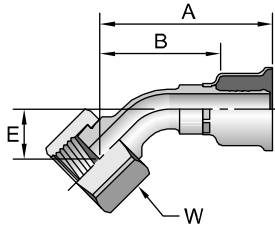

1J726

Female Seal-Lok - Swivel - 45° Elbow

# Part Number	Thread		Hose I.D. inch	A		E		inch	B	
	inch	inch		inch	mm	inch	mm		inch	mm
1J726-4-4	1/4	9/16x18	3/16	1.99	51	0.39	10	11/16	1.12	28
1J726-6-6	3/8	1-1/16x16	5/16	2.43	62	0.43	11	13/16	1.57	40
1J726-8-8	1/2	13/16x16	13/32	2.77	70	0.59	15	15/16	1.91	49
1J726-10-10	5/8	1x14	1/2	3.26	83	0.63	16	1-1/8	2.31	59
1J726-12-12	3/4	1-3/16x12	5/8	3.13	80	0.83	21	1-3/8	2.19	56
1J726-16-16	1	1-7/16x12	7/8	3.61	92	0.94	24	1-5/8	2.57	65
1J726-20-20	1-1/4	1-11/16x12	1-1/8	3.93	100	1.00	25	1-7/8	2.87	73

Fittings
26 Series
B

1J 26

Female Seal-Lok - Swivel - 0° Elbow - Short Drop

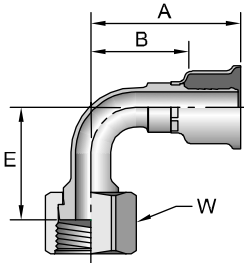

# Part Number	Thread		Hose I.D. inch	A		E		inch	B	
	inch	inch		inch	mm	inch	mm		inch	mm
1J926-4-4	1/4	9/16x18	3/16	1.80	46	0.83	21	11/16	0.93	24
1J926-6-6	3/8	1-1/16x16	5/16	1.86	47	0.91	23	13/16	1.00	25
1J926-8-8	1/2	13/16X16	13/32	2.14	54	1.14	29	15/16	1.28	33
1J926-10-10	5/8	1x14	1/2	2.53	64	1.26	32	1-1/8	1.58	40
1J926-12-12	3/4	1-3/16x12	5/8	2.51	64	1.89	48	1-3/8	1.57	40
1J926-16-16	1	1-7/16X12	7/8	3.56	90	2.21	56	1-5/8	2.52	64
1J926-20-20	1-1/4	1-11/16X12	1-1/8	4.05	103	2.51	64	1-7/8	2.99	76

Equipment
C

1S526

Male Tube- - Swivel - Short Pilot

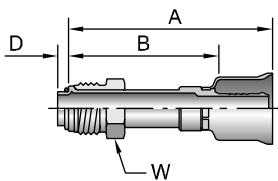

# Part Number	Thread		Hose I.D. inch	A		D		inch	B	
	inch	inch		inch	mm	inch	mm		inch	mm
1S526-6-6	3/8	5/8x18	5/16	2.54	65	0.18	4,7	5/8	1.68	43
1S526-7-6	11/16	11/16x16	5/16	2.57	65	0.18	4,7	5/8	1.71	43
1S526-8-8	1/2	3/4x18	13/32	2.68	68	0.18	4,7	3/4	1.82	46
1S526-10-10	5/8	7/8x18	1/2	3.46	88	0.18	4,7	7/8	2.51	64
1S526-10-12	5/8	7/8x18	5/8	3.63	92	0.18	4,7	7/8	2.69	68
1S526-12-12	3/4	1-1/16x16	5/8	4.00	102	0.18	4,7	1-1/16	3.06	78

When measuring overall length to the end of the nut, B D must be used to calculate cut-off allowance.

Accessories
D

Technical
E

See Accessories Section for O-Rings.



1S526-PR

Male Tube- - Swivel - Short Pilot
with Charge Port for R12

# Part Number	Thread inch		Hose I.D. inch	A		D				B		
	inch	mm		inch	mm	inch	mm	inch	mm	inch	mm	
1S526-10-10-PR	5/8	7/8x18	1/2	3.52	89	0.18	4,7	0.47	12	7/8	2.57	65
1S526-10-12-PR	5/8	7/8x18	5/8	3.68	93	0.18	4,7	0.47	12	7/8	2.74	70

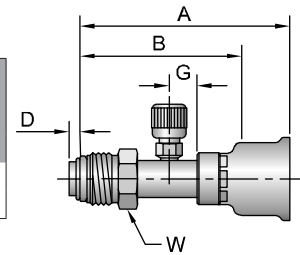

15R26

Male Tube- - Swivel - 45° Elbow - Short Pilot

# Part Number	Thread inch		Hose I.D. inch	A		D		E		B		
	inch	mm		inch	mm	inch	mm	inch	mm	inch	mm	
15R26-6-6	3/8	5/8x18	5/16	2.52	64	0.18	4,7	0.85	22	5/8	1.66	42
15R26-8-8	1/2	3/4x18	13/32	2.53	64	0.18	4,7	1.05	27	3/4	1.67	42
15R26-10-10	5/8	7/8x18	1/2	2.99	76	0.18	4,7	1.25	32	7/8	2.04	52
15R26-10-12	5/8	7/8x18	5/8	3.16	80	0.18	4,7	1.25	32	7/8	2.22	56

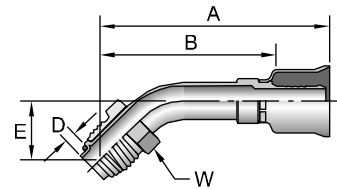

15 26

Male Tube- - Swivel - 0° Elbow - Short Pilot

# Part Number	Thread inch		Hose I.D. inch	A		D		E		B		
	inch	mm		inch	mm	inch	mm	inch	mm	inch	mm	
15 26-6-6	3/8	5/8X18	5/16	2.06	52	0.18	4,7	1.76	45	5/8	1.19	30
15 26-7-6	7/16	11/16x16	5/16	2.21	56	0.18	4,7	1.76	44	11/16	1.35	34
15 26-8-8	1/2	3/4x18	13/32	2.06	52	0.18	4,7	1.74	44	3/4	1.20	30
15 26-10-10	5/8	7/8x18	1/2	2.34	59	0.18	4,7	2.20	56	7/8	1.39	35
15 26-10-12	5/8	7/8x18	5/8	2.51	64	0.18	4,7	2.20	56	7/8	1.57	40

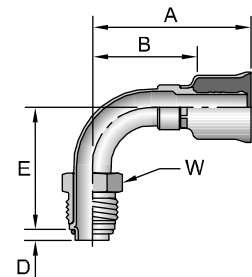

15 26-PB

Male Tube- - Swivel - 0° Elbow - Short Pilot
with High Pressure Charge Port for R134a

# Part Number	Thread inch		Hose I.D. inch	A		D		E		B				
	inch	mm		inch	mm	inch	mm	inch	mm	inch	mm			
15 26-8-8-PB	1/2	3/4x18	13/32	2.70	69	0.18	4,6	1.74	44	0.60	15	3/4	1.88	48

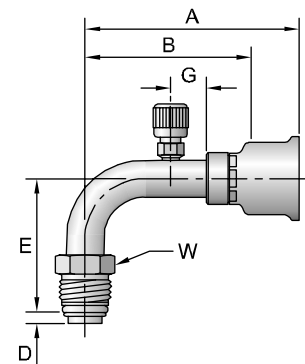

Hose
A

Fittings
26 Series
B

Equipment
C

Accessories
D

Technical
E

Hose
A

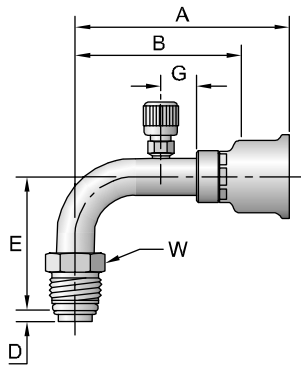

15 26-PR

Male Tube- - Swivel - 90° Elbow - Short Pilot
with Charge Port for R12

# Part Number	Thread		Hose I.D. inch	A		D		E		Hexagon		B		
	inch	mm		inch	mm	inch	mm	inch	mm	inch	mm	inch	mm	
15 26-10-10-PR	5/8	7/8x18	1/2	3.14	80	0.18	4,7	2.25	57	0.60	15	7/8	2.19	56
15 26-10-12-PR	5/8	7/8x18	5/8	3.43	87	0.18	4,7	2.22	56	0.60	15	7/8	2.49	63

Fittings
26 Series
B

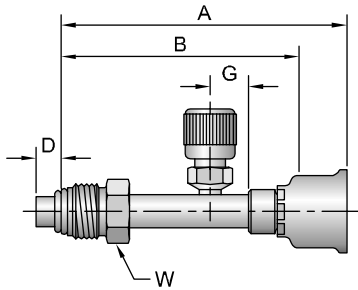

14526-PR

Male Tube- - Swivel - Long Pilot
with Charge Port for R12

# Part Number	Thread		Hose I.D. inch	A		D		E		Hexagon		B	
	inch	mm		inch	mm	inch	mm	inch	mm	inch	mm	inch	mm
14526-6-6-PR	3/8	5/8x18	5/16	3.25	83	0.28	7,1	0.50	13	5/8	2.40	61	

Equipment
C

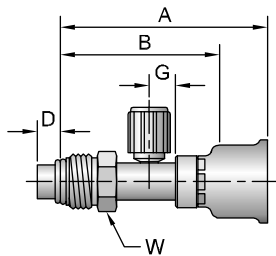

14526-PT

Male Tube- - Swivel - Long Pilot
with Charge Port for R134a

# Part Number	Thread		Hose I.D. inch	A		D		E		Hexagon		B	
	inch	mm		inch	mm	inch	mm	inch	mm	inch	mm	inch	mm
14526-10-12-PT	5/8	7/8x18	5/8	3.45	88	0.38	9,8	0.44	11	7/8	2.51	64	

Accessories
D

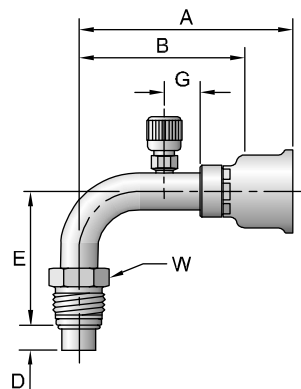

15M26-PR

Male Tube- - Swivel - 90° Elbow - Long Pilot
with Charge Port for R12

# Part Number	Thread		Hose I.D. inch	A		D		E		Hexagon		B		
	inch	mm		inch	mm	inch	mm	inch	mm	inch	mm	inch	mm	
15M26-6-6-PR	3/8	5/8x18	5/16	2.48	63	0.28	7,1	1.58	40	0.50	13	5/8	1.62	41

Technical
E

15M26-PT

Male Tube- - Swivel - 0° Elbow - Long Pilot with Charge Port for R134a

# Part Number	Thread		Hose I.D. inch	A		D		E		H			B	
	inch	mm		inch	mm	inch	mm	inch	mm	inch	mm	inch	mm	
15M26-10-12-PT	5/8	7/8x18	5/8	3.25	83	0.38	9,8	2.25	57	0.60	15	7/8	2.31	59

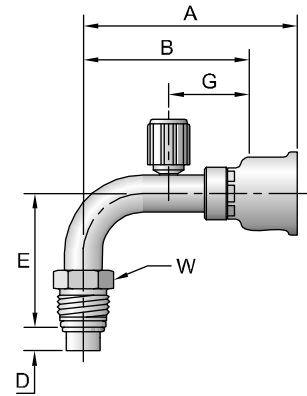

15 26

Male Tube- - Rigid - Internal Long Pilot (3-Step)

# Part Number	Thread		Hose I.D. inch	A		H inch	B	
	inch	mm		inch	mm		inch	mm
15 26-6-6	3/8	5/8x18	3/8	1.78	45	0.625	0.92	23
15 26-8-8	1/2	3/4x16	13/32	1.95	50	3/4	1.09	28
15 26-10-10	5/8	7/8x14	1/2	4.05	103	7/8	3.10	79
15 26-10-12	5/8	7/8x14	5/8	2.19	56	0.875	1.25	32

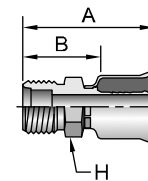

15 26-PR

Male Tube- - Rigid - Internal Long Pilot (3-Step) with Charge Port for R12

# Part Number	Thread		Hose I.D. inch	A		E		H			B	
	inch	mm		inch	mm	inch	mm	inch	mm	inch	mm	
15 26-10-12-PR	5/8	7/8x14	5/8	4.27	108	0.60	15	7/8	3.33	85		

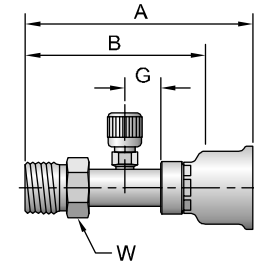

15S26

Female Tube- - Swivel - Short Pilot

# Part Number	Thread		Hose I.D. inch	A		D		H inch	B	
	inch	mm		inch	mm	inch	mm		inch	mm
15S26-6-6	3/8	5/8x18	5/16	2.54	65	0.18	4,7	3/4	1.68	43
15S26-8-8	1/2	3/4x16	13/32	2.68	68	0.18	4,7	7/8	1.82	46
15S26-10-10	5/8	7/8x14	1/2	2.84	72	0.18	4,7	1-1/16	1.89	48
15S26-10-12	5/8	7/8x14	5/8	3.63	92	0.18	4,7	1-1/16	2.69	68
15S26-12-12	3/4	1-1/16x14	5/8	4.00	102	0.18	4,7	1-1/4	3.06	78

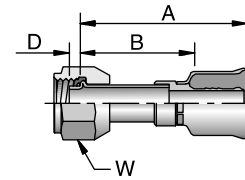

Hose
A

Fittings
26 Series
B

Equipment
C

Accessories
D

Technical
E



Hose
A

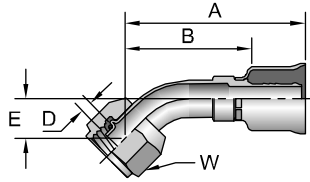

15H26

Female Tube- - Swivel 45 Elbow - Short Pilot

# Part Number	Thread		Hose I.D.	A		D		E		B		
	inch	mm	inch	inch	mm	inch	mm	inch	mm	inch	mm	mm
15H26-6-6	3/8	5/8x18	5/16	2.35	60	0.18	4,7	0.54	14	3/4	1.49	38
15H26-8-8	1/2	3/4x16	13/32	2.48	63	0.18	4,7	0.60	15	7/8	1.62	41
15H26-10-10	5/8	7/8x14	1/2	3.23	82	0.18	4,7	0.67	17	1 1/16	2.28	58
15H26-10-12	5/8	7/8x14	3/4	3.43	87	0.18	4,7	0.67	17	1-1/16	2.46	62

Fittings
26 Series
B

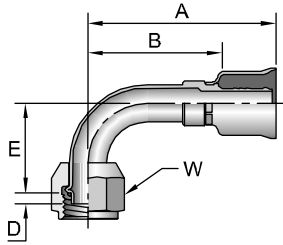

15T26

Female Tube- - Swivel - 0 Elbow - Short Pilot

# Part Number	Thread		Hose I.D.	A		D		E		B		
	inch	mm	inch	inch	mm	inch	mm	inch	mm	inch	mm	mm
15T26-6-6	3/8	5/8x18	5/16	1.89	48	0.18	4,7	1.15	29	3/4	1.03	26
15T26-8-8	1/2	3/4x16	13/32	2.34	59	0.18	4,7	1.46	37	7/8	1.48	38
15T26-10-10	5/8	7/8x14	1/2	2.08	53	0.18	4,7	1.75	44	1-1/16	1.08	27
15T26-10-12	5/8	7/8x14	5/8	2.20	56	0.18	4,7	1.53	39	1-1/16	1.26	32
15T26-12-12	3/4	1-1/16x14	5/8	2.63	67	0.18	4,7	1.75	44	1-1/4	1.69	43

Equipment
C

15 26-PB

Female Tube- - Swivel - Long Pilot
with High Pressure Charge Port for R134a

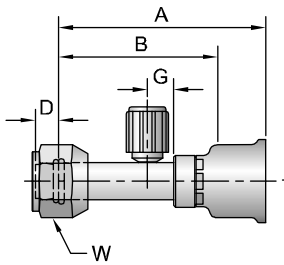

# Part Number	Thread		Hose I.D.	A		D		E		B		
	inch	mm	inch	inch	mm	inch	mm	inch	mm	inch	mm	mm
15926-6-6-PB	3/8	5/8x18	5/16	3.25	83	0.28	7,1	0.75	19	3/4	2.39	61
15926-8-8-PB	1/2	3/4x16	13/32	2.74	70	0.38	9,8	0.50	13	7/8	1.88	48

Accessories
D

15 26-PT

Female Tube- - Swivel - Long Pilot
with Low Pressure Charge Port for R134a

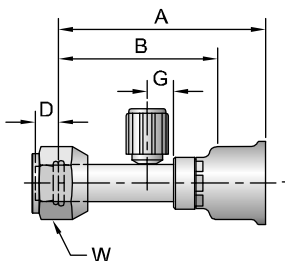

# Part Number	Thread		Hose I.D.	A		D		E		B		
	inch	mm	inch	inch	mm	inch	mm	inch	mm	inch	mm	mm
15926-10-12-PT	5/8	7/8x14	5/8	3.47	88	0.38	9,8	0.60	15	1-1/16	2.53	64

Technical
E

15N26-PB

Female Tube- - Swivel - 45° Elbow - Long Pilot
with High Pressure Charge Port for R134a

# Part Number	Thread		Hose I.D. inch	A		D		E		B				
	inch	mm		inch	mm	inch	mm	inch	mm	inch	mm			
15N26-8-8-PB	1/2	3/4x16	13/32	3.67	93	0.38	9,8	0.90	23	0.60	15	7/8	2.81	72

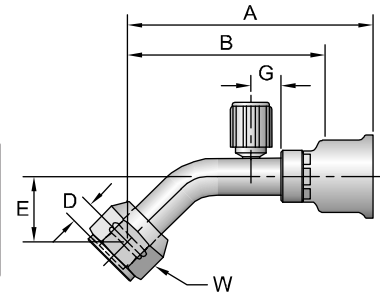

15N26-PT

Female Tube- - Swivel - 45° Elbow - Long Pilot
with Low Pressure Charge Port for R134a

# Part Number	Thread		Hose I.D. inch	A		D		E		B				
	inch	mm		inch	mm	inch	mm	inch	mm	inch	mm			
15N26-10-12-PT	5/8	7/8x14	5/8	3.92	100	0.38	9,8	1.21	31	0.60	15	1-1/16	2.98	76

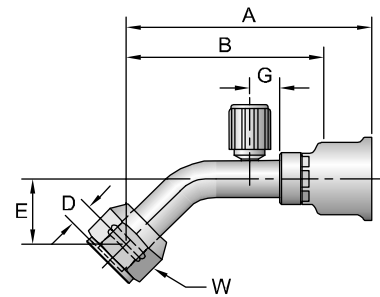

15L26

Female Tube- - Swivel - 0° Elbow - Long Pilot

# Part Number	Thread		Hose I.D. inch	A		D		E		B		
	inch	mm		inch	mm	inch	mm	inch	mm	inch	mm	
15L26-8-8	1/2	3/4x14	13/32	2.14	54	0.38	9,8	1.46	37	7/8	1.28	33

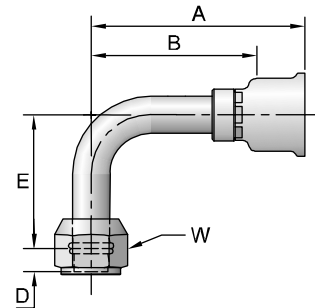

15L26-PB

Female Tube- - Swivel - 0° Elbow - Long Pilot
with High Pressure Charge Port for R134a

# Part Number	Thread		Hose I.D. inch	A		D		E		B				
	inch	mm		inch	mm	inch	mm	inch	mm	inch	mm			
15L26-6-6-PB	3/8	5/8x18	5/16	2.50	64	0.28	7,1	1.22	31	0.50	13	3/4	1.64	42
15L26-8-8-PB	1/2	3/4x16	13/32	2.80	71	0.38	9,8	1.46	37	0.60	15	7/8	1.94	49
15L26-10-12-PB	5/8	7/8x14	5/8	2.80	71	0.38	9,8	1.46	37	0.60	15	1-1/16	1.94	49

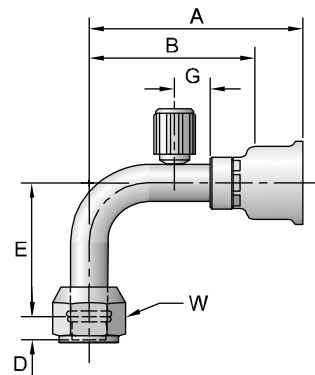

Hose
A

Fittings
26 Series
B

Equipment
C

Accessories
D

Technical
E



Hose
A

Fittings
26 Series
B

Equipment
C

Accessories
D

Technical
E

15L26-PR

Female Tube- - Swivel - 90° Elbow - Long Pilot
with Charge Port for R12

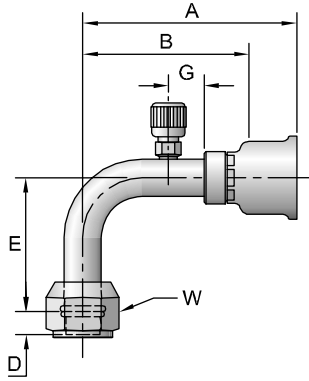

# Part Number	Thread inch	Hose I.D. inch	A		D		E		B			
			inch	mm	inch	mm	inch	mm	inch	mm		
15L26-8-8-PR	1/2 3/4x16	13/32	2.79	71	0.38	9,8	1.46	37	0.60	15	7/8 1.93	49
15L26-10-10-PR	5/8 7/8x14	1/2	3.59	91	0.38	9,8	2.25	57	0.60	15	1-1/16 2.64	67
15L26-10-12-PR	5/8 7/8x14	5/8	3.25	83	0.38	9,8	2.25	57	0.60	15	1-1/16 2.31	59

15L26-PT

Female Tube- - Swivel - 90° Elbow - Long Pilot
with Low Pressure Charge Port for R134a

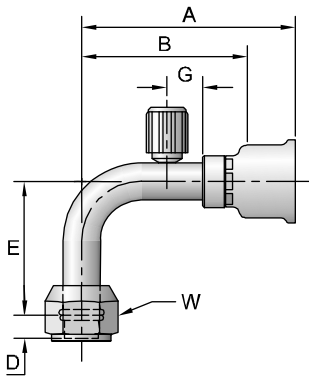

# Part Number	Thread inch	Hose I.D. inch	A		D		E		B			
			inch	mm	inch	mm	inch	mm	inch	mm		
15L26-10-10-PT	5/8 7/8x14	1/2	2.95	75	0.38	9,8	2.25	57	0.60	15	1-1/16 2.00	51
15L26-10-12-PT	5/8 7/8x14	5/8	3.25	83	0.38	9,8	2.25	57	0.60	15	1-1/16 2.31	59
15L26-12-12-PT	3/4 1-1/16x14	5/8	3.58	91	0.38	9,8	2.66	68	0.60	15	1-1/4 2.64	67

15P26-PT

Male Tube- - Swivel - 45° Elbow - Long Pilot
with Low Pressure Charge Port for R134a

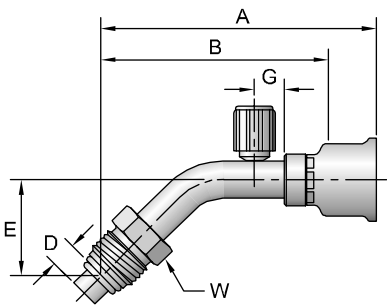

# Part Number	Thread inch	Hose I.D. inch	A		D		E		B			
			inch	mm	inch	mm	inch	mm	inch	mm		
15P26-10-12-PT	5/8 7/8x18	5/8	3.81	97	0.38	9,8	1.21	31	0.60	15	7/8 2.87	73

17B26

Female Air Brake Jounce Line - Swivel

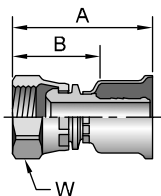

# Part Number	Thread inch	Hose inch	A		B		
			inch	mm	inch	mm	
17B26-8-6BA	1/2 3/4x20	5/16	1.75	44	11/16	0.89	23
17B26-8-8BA	1/2 3/4x20	13/32	1.75	44	11/16	0.89	23

15 26

Female Compressor - Swivel - 45 Elbow

# Part Number	Thread inch	Hose I.D. inch	A		E		inch	B	
			inch	mm	inch	mm		inch	mm
15V26-12-8	1x14	13/32	2.72	69	0.75	19	1-1/8	1.86	47
15V26-12-12	1x14	5/8	3.39	86	0.76	19	1-1/8	2.45	62

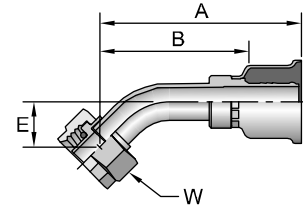

15 26

Female Compressor - Swivel - 0 Elbow

# Part Number	Thread inch	Hose I.D. inch	A		E		inch	B	
			inch	mm	inch	mm		inch	mm
15W26-12-8	1x14	13/32	2.24	57	1.25	32	1.125	1.38	35
15W26-12-12	1x14	5/8	3.04	77	1.63	41	1.125	2.10	53

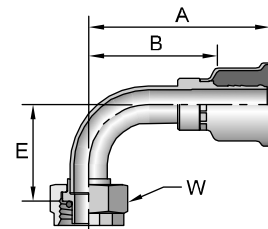

15 26

Female Compressor - Swivel - 0 Elbow - Block Type

# Part Number	Thread inch	Hose I.D. inch	A		E		inch	B	
			inch	mm	inch	mm		inch	mm
15 26-12-8	1X14	0.40625	1.79	45	0.80	20	1.125	0.93	24
15 26-12-12	1X14	0.625	1.87	47	0.80	20	1.125	0.93	24

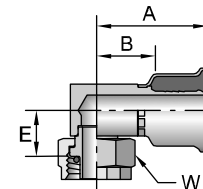

1R 26

Female Compressor - Swivel - 135 Elbow

# Part Number	Hose I.D. inch	inch	A		E		inch	B	
			inch	mm	inch	mm		inch	mm
1RV26-12-8	13/32	3.24	82	3.21	82	1-1/8	2.38	60	
1RV26-12-12	5/8	2.32	59	3.21	82	1-1/8	1.38	35	

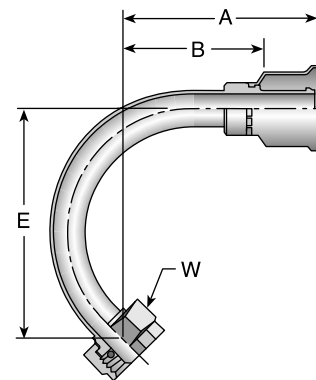

Hose
A

Fittings
26 Series
B

Equipment
C

Accessories
D

Technical
E

Hose
A

Fittings
26 Series
B

Equipment
C

Accessories
D

Technical
E

1R 26

Female Compressor - Swivel - 180 Elbow - Block Type R

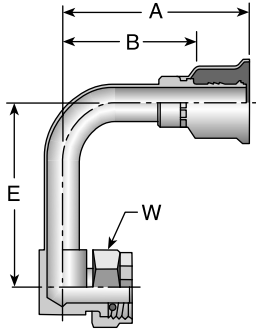

# Part Number	Thread inch	Hose I.D. inch	A		E		inch	B	
			inch	mm	inch	mm		inch	mm
1R 26-12-12	1x14	5/8	2.98	76	3.13	80	1-1/8	2.04	52

1T126

Male Refrigerant Tube Mender
(with Nut and Ferrule)

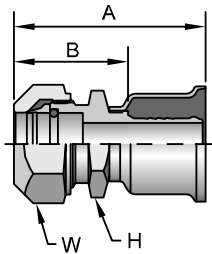

# Part Number	Thread inch		Hose I.D. inch	A		H inch	B	
	inch	mm		inch	mm		inch	mm
1T126-6-6	3/8	5/8x18	5/16	1.96	50	11/16	1.10	28
1T126-8-8	1/2	3/4x16	13/32	2.07	53	13/16	1.21	31
1T126-10-10	5/8	7/8x14	1/2	2.28	58	15/16	1.33	34
1T126-10-12	5/8	7/8x14	5/8	2.27	58	15/16	1.33	34
1T126-12-12	3/4	1-16x14	5/8	2.33	59	1-1/8	1.39	35

1T126 Assembly instructions on page B-25.

1T126

Fitting Installation Instructions

1. Cut the tube off squarely next to the hose fitting. At least 7/8" straight length is required and the outside diameter of the tube should be smooth and free from deep lengthwise scratches.
2. To prevent cutting the inside of the O-Ring, smoothly chamfer the outside diameter of the cut end 15 to 30 . Deburr the inside diameter.
3. Remove the nut, compression sleeve, and O-Ring from the fitting and lubricate the O-Ring with a lubricant that is compatible with the refrigerant used in the system.
4. Place the lubricated O-Ring in the counterbore of the fitting.
5. Slip the compression sleeve, small end, into the nut and assemble the nut on the fitting fingertight. Make sure the compression sleeve is not cocked in the nut. Back the nut off 1/6 to 1/3 turn (one to two hex flats).
6. Insert the chamfered tube end through the nut into the fitting. If high resistance is felt when the end of the tube contacts the O-Ring, remove the tube. The end of the tube may require a large chamfer and/or the O-Ring may require more lubrication on the inside diameter. Repeat the previous steps.
7. (a) Make sure the tube is bottomed in the fitting
(b) Tighten the nut finger tight
(c) Mark the fitting and nut hex indicating the starting point (see illustration) and
(d) Wrench tighten the nut 1 to 1-1/6 turns (6 to 7 hex flats).
8. Later, if it is ever necessary to loosen the connection, re-assemble the nut 1/6 turn (one hex flat) after finger tight.

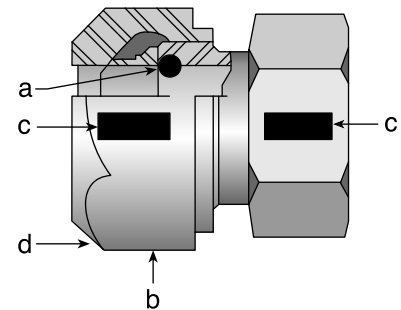

IF YOU HAVE QUESTIONS CONCERNING THE PRODUCTS
OR APPLICATION OF THE PRODUCTS CONTAINED IN THIS
CATALOG, PLEASE CALL:
PARKER HOSE PRODUCTS DIVISION
TECHNICAL SERVICES DEPARTMENT
PHONE: 440 / 943-5700
FAX: 440 / 943-3129
<http://www.parkerhose.com>

Hose

A

Fittings
26 Series

B

Equipment

C

Accessories

D

Technical

E











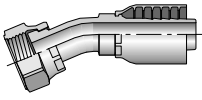
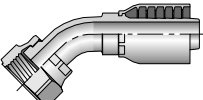
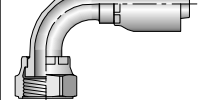
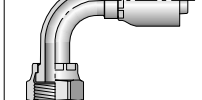
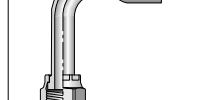

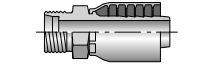
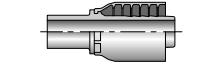
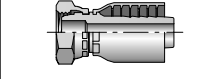
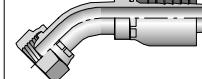

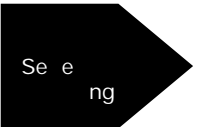
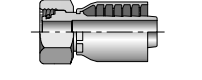

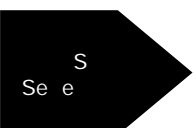
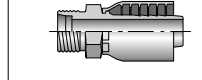
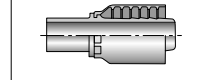
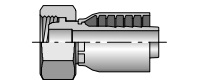
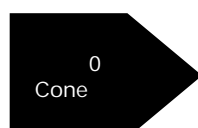
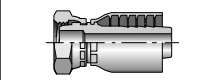
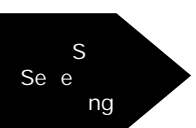
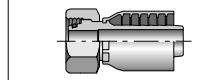
	10143 B-29 Female Rigid	11343 B-29 Female Swivel	11L43 B-30 Female Swivel Elbow	10243 B-30 Female Rigid	1S243 B-31 Female Swivel
	10743 B-30 Female Swivel		10543 B-31 Female Rigid	10 43 B-31 Female Swivel	10L43 B-32 Female Swivel Elbow
	10343 B-32 Female Rigid	1LB43 B-33 Female Elbow Head	10643 B-33 Female Swivel	13743 B-34 Female Swivel Elbow Short	1L743 B-34 Female Swivel Elbow Medium
13943 B-35 Female Swivel Elbow Short	1L943 B-35 Female Swivel Elbow Medium	14143 B-36 Female Swivel Elbow Long	14V43 B-36 Female Swivel Elbow 1		10443 B-36 Female Rigid
10843 B-36 Female Swivel	17743 B-37 Female Swivel Elbow	17943 B-37 Female Swivel Elbow		11143 B-37 Female Rigid	11243 B-38 Female Swivel
1 J43 B-38 Female Rigid		12843 B-38 Female Swivel	16743 B-39 Female Swivel Elbow	16943 B-39 Female Swivel Elbow	
11543 B-39 Flange Head	11643 B-40 22 1/2 Elbow	12643 B-40 Elbow	11743 B-40 Elbow	12743 B-41 Elbow	11843 B-41 7 1/2 Elbow
11943 B-41 Elbow		1J043 B-42 Female Rigid w/ Ring	1JB43 B-42 Female Elbow Head w/ Ring	1JC43 B-43 Female Swivel Short	1JS43 B-44 Female Swivel Long

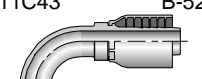
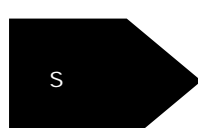
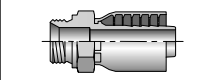
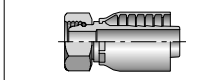
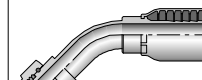
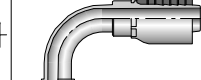
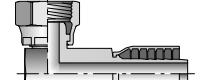
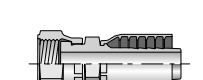
Hose	A
Fittings 43 Series	B
Equipment	C
Accessories	D
Technical	E

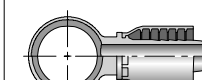
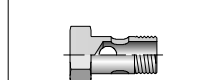
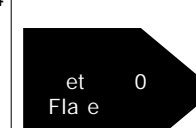
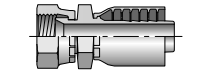
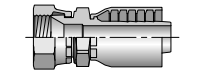

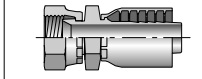
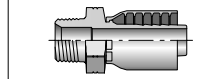
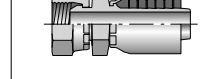
A Hose
 B Fittings 43 Series
 C Equipment
 D Accessories
 E Technical

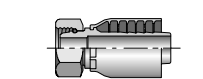
1J643 B-44  emale Swivel 22 1/2 lbow	1J743 B-45  emale Swivel lbow	1J943 B-46  emale Swivel lbow Short	1J543 B-46  emale Swivel lbow eduim	1J143 B-47  emale Swivel lbow ong	 Se e
1D043 B-47  ale Rigid	11D43 B-47  ale Standpipe Rigid	1C343 B-48  emale Swivel	1C443 B-48  emale Swivel lbow	1C543 B-48  emale Swivel lbow	 Se e ng
1CA43 B-49  emale Swivel	1CE43 B-49  emale Swivel lbow	1CF43 B-49  emale Swivel lbow	 S Se e	1D243 B-50  ale Rigid	13D43 B-50  ale Standpipe Rigid
1C643 B-50  emale Swivel	 0 Cone	1C043 B-51  emale Swivel	 S Se e ng	1C943 B-51  emale Swivel	10C43 B-51  emale Swivel lbow
11C43 B-52  emale Swivel lbow	 S	1D943 B-52  ale Rigid	19243 B-52  emale Swivel	1B143 B-53  emale Swivel lbow	1B243 B-53  emale Swivel lbow
1B443 B-53  emale Swivel lbow loc Type	1B543 B-54  emale Swivel lat Seat	 an o	14943 B-54  etric an o	AM B-54  olt	 et Fla e 0
1MU43 B-55  emale Swivel	1XU43 B-55  emale Swivel	 S	1FU43 B-56  emale Swivel	1UT43 B-56  ale Rigid	1 U43 B-56  emale Swivel
 F en a	1F443 B-56  emale Swivel				

10143

Male NPTF Pipe - Rigid

# Part Number	Thread inch	Hose I.D. inch	A		H inch	B		Additional Material Stainless Steel (C)
			inch	mm		inch	mm	
10143-2-4	1/8x27	1/4	1.80	46	9/16	1.05	27	
10143-4-4	1/4x18	1/4	2.01	51	9/16	1.26	32	
10143-4-5	1/4x18	5/16	1.94	49	11/16	1.19	30	
10143-4-6	1/4x18	3/8	2.28	58	3/4	1.25	32	
10143-6-4	3/8x18	1/4	1.86	47	11/16	1.11	28	
10143-6-5	3/8x18	5/16	1.94	49	11/16	1.19	30	
10143-6-6	3/8x18	3/8	2.37	60	3/4	1.34	34	
10143-6-8	3/8x18	1/2	2.59	66	7/8	1.33	34	
10143-6-10	3/8x18	5/8	2.61	66	15/16	1.17	30	
10143-8-4	1/2x14	1/4	2.13	54	7/8	1.38	35	
10143-8-6	1/2x14	3/8	2.39	61	7/8	1.36	35	
10143-8-8	1/2x14	1/2	2.84	72	7/8	1.58	40	
10143-8-10	1/2x14	5/8	3.04	77	15/16	1.59	40	
10143-8-12	1/2x14	3/4	3.04	77	1-1/16	1.60	41	
10143-12-8	3/4x14	1/2	2.68	68	1-1/16	1.42	36	
10143-12-10	3/4x14	5/8	2.87	73	1-1/16	1.43	36	
10143-12-12	3/4x14	3/4	3.09	78	1-1/16	1.65	42	
10143-12-16	3/4x14	1	3.40	86	1-3/8	1.78	45	
10143-16-12	1x11-1/2	3/4	3.09	78	1-3/8	1.65	42	
10143-16-16	1x11-1/2	1	2.59	66	1-3/8	1.97	50	
10143-20-20	1-1/4x11-1/2	1-1/4	4.08	104	1-3/4	2.39	61	
10143-24-24	1-1/2x11-1/2	1-1/2	3.50	89	2	2.13	54	
10143-32-32	2x11-1/2	2	4.05	103	2-1/2	2.27	58	

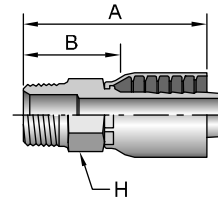

Stainless steel fittings must be assembled with arraykrimp 2, PHastkrimp, Superkrimp or Parkrimp 2. See CrimpSource for more information.

11343

Male NPTF Pipe - Swivel

# Part Number	Thread inch	Hose I.D. inch	A		H inch	B		Additional Material Stainless Steel (C)
			inch	mm		inch	mm	
11343-2-4	1/8x27	1/4	2.94	75	5/8	2.19	56	
11343-4-4	1/4x18	1/4	2.68	68	5/8	1.93	49	
11343-4-6	1/4x18	3/8	3.01	76	5/8	1.98	50	
11343-6-4	3/8x18	1/4	2.81	71	3/4	2.06	52	
11343-6-6	3/8x18	3/8	3.08	78	3/4	2.05	52	
11343-6-8	3/8x18	1/2	3.30	84	3/4	2.04	52	
11343-8-6	1/2x14	3/8	3.30	84	7/8	2.27	58	
11343-8-8	1/2x14	1/2	3.52	89	7/8	2.26	57	
11343-12-12	3/4x14	3/4	3.93	100	1-1/4	2.49	63	
11343-16-16	1x11-1/2	1	4.52	115	1-1/2	2.90	74	

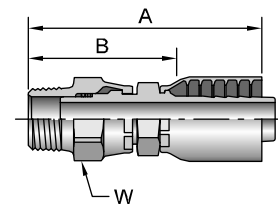

O-Ring not compatible with Phosphate Ester fluids.

Fitting allows minor movement under pressure to relieve stress on hose but is not to be used on continuous or extensive swiveling.

Hose
A

Fittings
43 Series
B

Equipment
C

Accessories
D

Technical
E



Hose
A

Fittings
43 Series
B

Equipment
C

Accessories
D

Technical
E

11L43

Male NPTF Pipe - Swivel - 0° Elbow

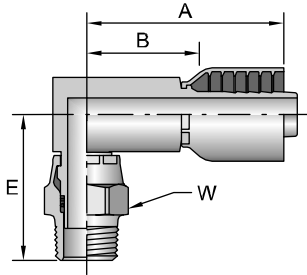

# Part Number	Thread inch	Hose I.D. inch	A		E		inch	B	
			inch	mm	inch	mm		inch	mm
11L43-4-4	1/4x18	1/4	2.23	57	1.79	45	5/8	1.48	38
11L43-4-6	1/4x18	3/8	2.53	64	1.85	47	5/8	1.50	38
11L43-6-6	3/8x18	3/8	2.53	64	1.94	49	3/4	1.50	38
11L43-8-6	1/2x14	3/8	2.66	68	2.17	55	7/8	1.63	41
11L43-8-8	1/2x14	1/2	2.96	75	2.17	55	7/8	1.70	43
11L43-12-12	3/4x14	3/4	3.32	84	2.46	62	1-1/4	1.88	48

O-Ring not compatible with Phosphate Ester fluids.

Fitting allows minor movement under pressure to relieve stress on hose but is not to be used on continuous or extensive swiveling.

10243

Female NPTF Pipe - Rigid

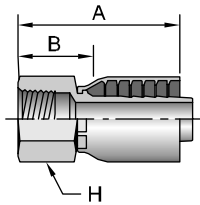

# Part Number	Thread inch	Hose I.D. inch	A		H inch	B	
			inch	mm		inch	mm
10243-2-4	1/8x27	1/4	1.68	43	5/8	0.93	24
10243-4-4	1/4x18	1/4	1.78	45	11/16	1.03	26
10243-4-6	1/4x18	3/8	2.05	52	3/4	1.02	26
10243-6-4	3/8x18	1/4	2.05	52	7/8	1.30	33
10243-6-6	3/8x18	3/8	2.32	59	7/8	1.29	33
10243-8-6	1/2x14	3/8	2.40	61	1-1/8	1.37	35
10243-8-8	1/2x14	1/2	2.62	67	1-1/8	1.36	35
10243-12-12	3/4x14	3/4	2.72	69	1-1/4	1.28	33

10743

Female NPSM Pipe - Swivel - (60° Cone)

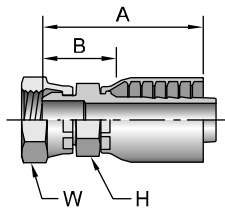

# Part Number	Thread inch	Hose I.D. inch	A		H		B	
			inch	mm	inch	inch	inch	mm
10743-2-4	1/8x27	1/4	1.69	43	9/16	9/16	0.94	24
10743-4-4	1/4x18	1/4	1.74	44	9/16	11/16	0.99	25
10743-6-6	3/8x18	3/8	2.09	53	11/16	7/8	1.06	27
10743-8-8	1/2x14	1/2	2.32	59	15/16	1	1.06	27
10743-12-12	3/4x14	3/4	2.70	69	1-1/16	1-1/4	1.47	37
10743-16-16	1x11-1/2	1	3.09	78	1-3/8	1-1/2	1.47	37
10743-20-20	1-1/4x11-1/2	1-1/4	3.28	83	1-7/8	1-7/8	1.59	40

1S243

Female NPTF Pipe - Swivel

# Part Number	Thread inch		Hose I.D. inch		A inch mm		B inch mm		
1S243-4-4	1/4x18		1/4		3.33	85	3/4	2.58	66

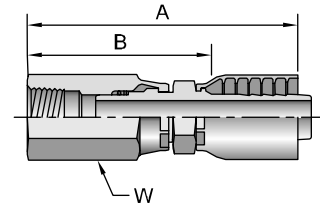

10543

Male SAE Straight Thread with -Ring - Rigid

# Part Number	Thread inch		Hose I.D. inch		A inch mm		H inch		B inch mm	
10543-4-4	1/4	7/16x20	1/4		1.64	42	9/16	0.89	23	
10543-5-4	5/16	1/2x20	1/4		1.80	46	5/8	1.05	27	
10543-6-4	3/8	9/16x18	1/4		1.67	42	11/16	0.92	23	
10543-6-6	3/8	9/16x18	3/8		2.10	53	11/16	1.07	27	
10543-6-8	3/8	9/16x18	1/2		2.32	59	13/16	1.06	27	
10543-8-6	1/2	3/4x16	3/8		2.11	54	7/8	1.08	27	
10543-8-8	1/2	3/4x16	1/2		2.46	62	7/8	1.20	30	
10543-10-6	5/8	7/8x14	3/8		2.13	54	1	1.10	28	
10543-10-8	5/8	7/8x14	1/2		2.35	60	1	1.09	28	
10543-10-10	5/8	7/8x14	5/8		2.77	70	1	1.33	34	
10543-12-8	3/4	1-1/16x12	1/2		2.61	66	1-1/4	1.35	34	
10543-12-10	3/4	1-1/16x12	5/8		2.80	71	1-1/4	1.36	35	
10543-12-12	3/4	1-1/16x12	3/4		2.81	71	1-1/4	1.37	35	
10543-16-12	1	1-5/16x12	3/4		2.81	71	1-1/2	1.37	35	
10543-16-16	1	1-5/16x12	1		3.37	86	1-1/2	1.75	44	
10543-20-20	1-1/4	1-5/8x12	1-1/4		3.69	94	1-7/8	2.00	51	

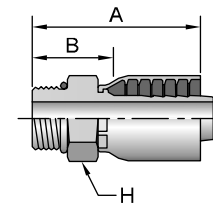

10 43

Male SAE Straight Thread with -Ring - Swivel

# Part Number	Thread inch		Hose I.D. inch		A inch mm		B inch mm		
10 43-5-4	5/16	1/2x20	1/4		2.98	76	3/4	2.23	57
10 43-6-4	3/8	9/16x18	1/4		2.98	76	3/4	2.23	57
10 43-6-6	3/8	9/16x18	3/8		3.25	83	3/4	2.22	56
10 43-8-6	1/2	3/4x16	3/8		3.06	78	7/8	2.06	52
10 43-8-8	1/2	3/4x16	1/2		3.21	82	7/8	1.95	50
10 43-10-6	5/8	7/8x14	3/8		3.01	76	1	2.01	51
10 43-10-8	5/8	7/8x14	1/2		3.27	83	1	2.01	51
10 43-12-12	3/4	1-1/16x12	3/4		3.78	96	1-1/4	2.34	59

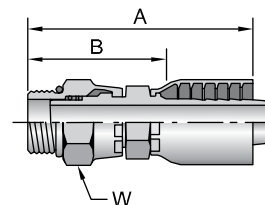

O-Ring not compatible with Phosphate Ester fluids.

Fitting allows minor movement under pressure to relieve stress on hose but is not to be used on continuous or extensive swiveling.

Hose
A

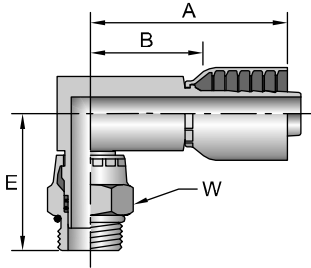

10L43

Male SAE Straight Thread with -Ring - Swivel - 0° Elbow

# Part Number	Thread		Hose I.D. inch	A		E		inch	B	
	inch	mm		inch	mm	inch	mm			
10L43-6-6	3/8	9/16x18	3/8	2.53	64	2.10	53	3/4	1.50	38
10L43-8-6	1/2	3/4x16	3/8	2.66	68	1.86	47	7/8	1.63	41
10L43-8-8	1/2	3/4x16	1/2	2.96	75	1.87	47	7/8	1.70	43
10L43-10-8	5/8	7/8x14	1/2	2.96	75	1.92	49	1	1.70	43
10L43-12-12	3/4	1-1/16x12	3/4	3.22	82	2.30	58	1-1/4	1.88	48

O-Ring not compatible with Phosphate Ester fluids.

See Technical Section for pressure limitations.

Fitting allows minor movement under pressure to relieve stress on hose but is not to be used on continuous or extensive swiveling.

Fittings
43 Series
B

10343

Male JIC 37° - Rigid

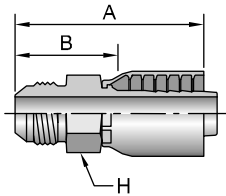

# Part Number	Thread		Hose I.D. inch	A		H inch	B	
	inch	mm		inch	mm		inch	mm
10343-4-4	1/4	7/16x20	1/4	1.99	51	9/16	1.24	31
10343-5-4	5/16	1/2x20	1/4	1.83	46	9/16	1.08	27
10343-5-6	5/16	1/2x20	3/8	2.26	57	3/4	1.23	31
10343-6-4	3/8	9/16x18	1/4	1.84	47	11/16	1.09	28
10343-6-6	3/8	9/16x18	3/8	2.36	60	3/4	1.33	34
10343-8-6	1/2	3/4x16	3/8	2.30	58	7/8	1.27	32
10343-8-8	1/2	3/4x16	1/2	2.68	68	7/8	1.42	36
10343-8-10	1/2	3/4x16	5/8	2.85	72	7/8	1.41	36
10343-10-6	5/8	7/8x14	3/8	2.40	61	15/16	1.37	35
10343-10-8	5/8	7/8x14	1/2	2.62	67	15/16	1.36	35
10343-10-10	5/8	7/8x14	5/8	3.03	77	15/16	1.59	40
10343-12-8	3/4	1-1/16x12	1/2	2.76	70	1-1/8	1.50	38
10343-12-10	3/4	1-1/16x12	5/8	3.07	78	1-1/8	1.63	41
10343-12-12	3/4	1-1/16x12	3/4	3.19	81	1-1/8	1.75	44
10343-14-12	7/8	1-3/16x12	3/4	3.11	79	1-1/4	1.67	42
10343-16-12	1	1-5/16x12	3/4	3.04	77	1-3/8	1.60	41
10343-16-16	1	1-5/16x12	1	3.63	92	1-3/8	2.01	51
10343-20-20	1-1/4	1-5/8x12	1-1/4	3.96	101	1-7/8	2.27	58
10343-24-20	1-1/2	1-7/8x12	1-1/4	3.71	94	2	2.02	51

Must be assembled with Die Part No. 83C-A20H in a Superkrimp or Parkrimp 2.

Equipment
C

Accessories
D

Technical
E

1LB43

Male JIC 37° - Bulkhead without Locknut

# Part Number	Thread		Hose I.D. inch	A		H inch	B	
	inch	7/16x20		inch	mm		inch	mm
1LB43-4-4	1/4	7/16x20	1/4	2.64	67	9/16	1.89	48
1LB43-6-6	3/8	9/16x18	3/8	3.08	78	3/4	2.05	52
1LB43-8-8	1/2	3/4x16	1/2	3.46	88	7/8	2.20	56
1LB43-10-10	5/8	7/8x14	5/8	3.85	98	15/16	2.41	61
1LB43-12-12	3/4	1-1/16x12	3/4	4.08	104	1-1/8	2.64	67

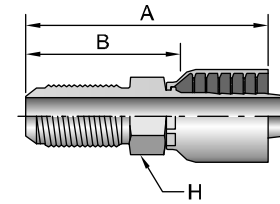

Fittings are stocked less locknut (part no. WLN). Locknuts are manufactured by the Parker Tube Fittings Division and must be ordered separately.

10643

Female JIC 37° - Swivel

# Part Number	Thread		Hose I.D. inch	A		H		B		Additional Material Stainless Steel (C)
	inch	7/16x20		inch	mm	inch	inch	inch	mm	
10643-4-4	1/4	7/16x20	1/4	1.94	49	9/16	9/16	1.19	30	
10643-4-6	1/4	7/16x20	3/8	2.20	56	11/16	9/16	1.17	30	
10643-5-4	5/16	1/2x20	1/4	2.03	52	9/16	5/8	1.28	33	
10643-5-5	5/16	1/2x20	5/16	2.08	53	11/16	5/8	1.33	34	
10643-5-6	5/16	1/2x20	3/8	2.26	57	11/16	5/8	1.23	31	
10643-6-4	3/8	9/16x18	1/4	2.05	52	9/16	11/16	1.30	33	
10643-6-5	3/8	9/16x18	5/16	2.10	53	11/16	11/16	1.35	34	
10643-6-6	3/8	9/16x18	3/8	2.29	58	11/16	11/16	1.26	32	
10643-6-8	3/8	9/16x18	1/2	2.51	64	13/16	11/16	1.25	32	
10643-8-6	1/2	3/4x16	3/8	2.49	63	11/16	7/8	1.46	37	
10643-8-8	1/2	3/4x16	1/2	2.63	67	13/16	7/8	1.37	35	
10643-8-10	1/2	3/4x16	5/8	2.82	72	15/16	7/8	1.38	35	
10643-8-12	1/2	3/4x16	3/4	2.83	72	1-1/16	7/8	1.39	35	
10643-10-6	5/8	7/8x14	3/8	2.51	64	7/8	1	1.48	38	
10643-10-8	5/8	7/8x14	1/2	2.85	72	7/8	1	1.59	40	
10643-10-10	5/8	7/8x14	5/8	2.93	74	15/16	1	1.49	38	
10643-10-12	5/8	7/8x14	3/4	2.93	74	1-1/16	1	1.49	38	
10643-12-8	3/4	1-1/16x12	1/2	2.78	71	1-1/16	1-1/4	1.52	39	
10643-12-10	3/4	1-1/16x12	5/8	3.10	79	1-1/16	1-1/4	1.66	42	
10643-12-12	3/4	1-1/16x12	3/4	3.17	81	1-1/16	1-1/4	1.73	44	
10643-12-16	3/4	1-1/16x12	1	3.29	84	1-3/8	1-1/4	1.67	42	
10643-14-12	7/8	1-3/16x12	3/4	3.18	81	1-1/4	1-3/8	1.74	44	
10643-16-12	1	1-5/16x12	3/4	3.31	84	1-1/4	1-1/2	1.87	47	
10643-16-16	1	1-5/16x12	1	3.62	92	1-3/8	1-1/2	2.00	51	
10643-20-16	1-1/4	1-5/8x12	1	3.81	97	1-5/8	2	2.19	56	
10643-20-20	1-1/4	1-5/8x12	1-1/4	3.94	100	1-7/8	2	2.25	57	
10643-24-24	1-1/2	1-7/8x12	1-1/2	3.84	98	2-1/8	2-1/4	2.47	63	
10643-32-32	2	2-1/2x12	2	4.73	120	2-1/2	2-7/8	2.95	75	

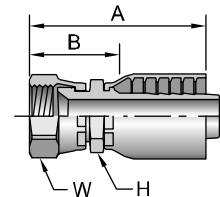

Stainless steel fittings must be assembled with arrykrimp 2, PHastkrimp, Superkrimp or Parkrimp 2. See CrimpSource for more information.

Hose
A

Fittings
43 Series
B

Equipment
C

Accessories
D

Technical
E

Hose
A

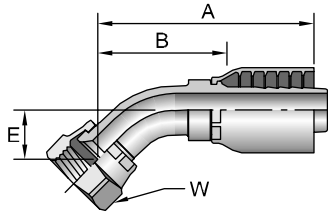

13743

Female JIC 37° - Swivel - 45° Elbow - Short Drop

# Part Number	Thread		Hose I.D. inch	A		E		B		
	inch	inch		inch	mm	inch	mm	inch	mm	
13743-4-4	1/4	7/16x20	1/4	1.96	50	0.39	10	9/16	1.21	31
13743-5-4	5/16	1/2x20	1/4	2.19	56	0.39	10	5/8	1.44	37
13743-6-4	3/8	9/16x18	1/4	2.23	57	0.39	10	11/16	1.48	38
13743-6-6	3/8	9/16x18	3/8	2.39	61	0.39	10	11/16	1.39	35
13743-8-6	1/2	3/4x16	3/8	2.74	70	0.55	14	7/8	1.74	44
13743-8-8	1/2	3/4x16	1/2	2.83	72	0.55	14	7/8	1.57	40
13743-10-8	5/8	7/8x14	1/2	2.93	74	0.63	16	1	1.67	42
13743-10-10	5/8	7/8x14	5/8	3.17	81	0.63	16	1	1.73	44
13743-12-10	3/4	1-1/16x12	5/8	3.62	92	0.83	21	1-1/4	2.08	53
13743-12-12	3/4	1-1/16x12	3/4	3.63	92	0.78	20	1-1/4	2.19	56
13743-16-16	1	1-5/16x12	1	4.34	110	0.95	24	1-1/2	2.72	69
13743-20-20	1-1/4	1-5/8x12	1-1/4	4.59	117	1.19	30	2	2.82	72
13743-24-24	1-1/2	1-7/8x12	1-1/2	5.50	140	1.47	37	2-1/4	4.18	106

Fittings
43 Series
B

1L743

Female JIC 37° - Swivel - 45° Elbow - Medium Drop

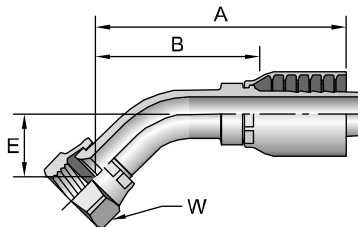

# Part Number	Thread		Hose I.D. inch	A		E		B		
	inch	inch		inch	mm	inch	mm	inch	mm	
1L743-6-6	3/8	9/16x18	3/8	2.66	62	0.59	15	11/16	1.63	41
1L743-8-8	1/2	3/4x16	1/2	3.17	80	0.72	18	7/8	1.91	49
1L743-12-12	3/4	1-1/16x12	3/4	4.23	107	1.06	27	1-1/4	2.79	71
1L743-16-16	1	1-5/16x12	1	4.51	115	1.07	27	1-1/2	2.89	73

Equipment
C

Accessories
D

Technical
E



13 43

Female JIC 37° - Swivel - 0° Elbow - Short Drop

# Part Number	Thread		Hose I.D. inch	A		E		inch	B	
	inch	7/16x20		inch	mm	inch	mm		inch	mm
13943-4-4	1/4	7/16x20	1/4	1.78	45	0.83	21	9/16	1.03	26
13943-4-6	1/4	7/16x20	3/8	2.11	54	0.83	21	9/16	1.08	27
13943-5-4	5/16	1/2x20	1/4	1.88	48	0.83	21	5/8	1.13	29
13943-5-5	5/16	1/2x20	5/16	1.96	50	0.83	21	5/8	1.21	31
13943-6-4	3/8	9/16x18	1/4	2.12	54	0.85	22	11/16	1.37	35
13943-6-6	3/8	9/16x18	3/8	2.21	56	0.91	23	11/16	1.18	30
13943-6-8	3/8	9/16x18	1/2	2.51	64	0.85	22	11/16	1.25	32
13943-8-6	1/2	3/4x16	3/8	2.52	64	1.09	28	7/8	1.49	38
13943-8-8	1/2	3/4x16	1/2	2.62	67	1.14	29	7/8	1.36	35
13943-10-8	5/8	7/8x14	1/2	2.74	70	1.26	32	1	1.48	38
13943-10-10	5/8	7/8x14	5/8	2.97	75	1.26	32	1	1.69	39
13943-12-8	3/4	1-1/16x12	1/2	3.25	83	1.83	46	1-1/4	1.99	51
13943-12-10	3/4	1-1/16x12	5/8	3.07	78	1.89	48	1-1/4	1.63	41
13943-12-12	3/4	1-1/16x12	3/4	3.49	89	1.89	48	1-1/4	2.05	52
13943-16-12	1	1-5/16x12	3/4	3.49	89	2.00	51	1-1/2	2.05	52
13943-16-16	1	1-5/16x12	1	4.28	109	2.20	56	1-1/2	2.66	68
13943-20-20	1-1/4	1-5/8x12	1-1/4	4.43	113	2.59	66	2	2.74	70
13943-24-24	1-1/2	1-7/8x12	1-1/2	5.50	140	3.81	81	2-1/4	4.13	105

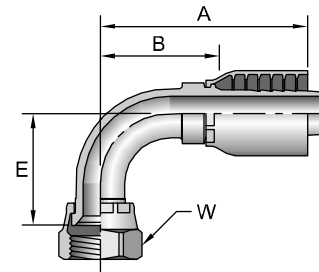

1L 43

Female JIC 37° - Swivel - 0° Elbow - Medium Drop

# Part Number	Thread		Hose I.D. inch	A		E		inch	B	
	inch	7/16x20		inch	mm	inch	mm		inch	mm
1L943-4-4	1/4	7/16x20	1/4	1.84	47	0.88	22	9/16	1.09	28
1L943-6-4	3/8	9/16x18	1/4	2.12	54	1.50	38	11/16	1.37	35
1L943-6-6	3/8	9/16x18	3/8	2.29	58	1.12	28	11/16	1.26	32
1L943-8-6	1/2	3/4x16	3/8	2.51	64	1.38	35	7/8	1.48	38
1L943-8-8	1/2	3/4x16	1/2	2.64	67	1.38	35	7/8	1.38	35
1L943-10-8	5/8	7/8x14	1/2	3.25	83	1.75	44	1	1.99	51
1L943-12-12	3/4	1-1/16x12	3/4	3.49	89	2.28	58	1-1/4	2.05	52
1L943-16-16	1	1-5/16x12	1	4.44	113	2.50	64	1-1/2	2.82	72

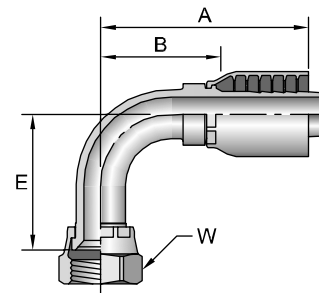

Hose
A

Fittings
43 Series
B

Equipment
C

Accessories
D

Technical
E

Hose
A

Fittings
43 Series
B

Equipment
C

Accessories
D

Technical
E

14143

Female JIC 37° - Swivel - 0° Elbow - Long Drop

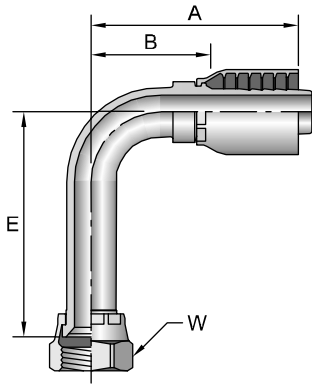

# Part Number	Thread inch		Hose I.D. inch	A		E		B		
	inch	mm		inch	mm	inch	mm	inch	mm	
14143-4-4	1/4	7/16x20	1/4	1.96	50	1.81	46	9/16	1.21	31
14143-5-4	5/16	1/2x20	1/4	1.93	49	1.80	46	5/8	1.18	30
14143-6-6	3/8	9/16x18	3/8	2.27	58	2.18	55	11/16	1.27	32
14143-8-6	1/2	3/4x16	3/8	2.56	65	2.43	62	7/8	1.56	40
14143-8-8	1/2	3/4x16	1/2	2.62	67	2.52	64	7/8	1.36	35
14143-10-8	5/8	7/8x14	1/2	2.78	71	2.58	66	1	1.52	39
14143-10-10	5/8	7/8x14	5/8	3.16	80	2.58	66	1	1.75	44
14143-12-12	3/4	1-1/16x12	3/4	3.49	89	3.74	95	1-1/4	2.05	52
14143-14-12	7/8	1-3/16x12	3/4	3.38	86	3.93	100	1-3/8	1.95	50
14143-16-16	1	1-5/16x12	1	3.90	99	4.32	110	1-1/2	2.31	59
14143-20-20	1-1/4	1-5/8x12	1-1/4	4.39	112	5.28	134	2	2.73	69

14 43

Female JIC 37° - Swivel - 150° Elbow

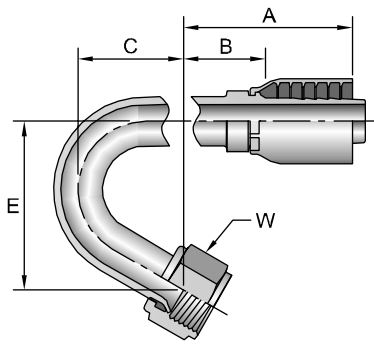

# Part Number	Thread inch		Hose I.D. inch	A		C		E		B		
	inch	mm		inch	mm	inch	mm	inch	mm	inch	mm	
14V43-6-4	3/8	9/16x18	1/4	2.89	73	1.36	11/16	1.97	50	11/16	2.16	55

10443

Male SAE 45° - Rigid

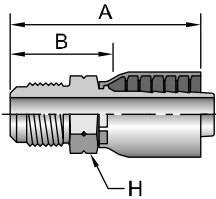

# Part Number	Thread inch		Hose I.D. inch	A		H		B	
	inch	mm		inch	mm	inch	mm	inch	mm
10443-6-6	3/8	5/8x18	3/8	2.21	56	3/4	1.21	31	
10443-12-12	3/4	1-1/16x14	3/4	3.20	81	1-1/8	1.77	45	

10843

Female SAE 45° - Swivel

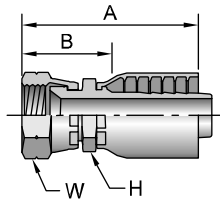

# Part Number	Thread inch		Hose I.D. inch	A		H		B	
	inch	mm		inch	mm	inch	mm	inch	mm
10843-6-4	3/8	5/8x18	1/4	2.11	54	3/4	3/4	1.36	35
10843-6-6	3/8	5/8x18	3/8	2.38	60	3/4	3/4	1.35	34
10843-12-12	3/4	1-1/16x14	3/4	3.17	81	1-1/16	1-1/4	1.73	44

Notch on nut signifies SAE 45 flare.



17743

Female SAE 45° - Swivel - 45° Elbow

# Part Number	Thread		Hose I.D. inch	A		E		B		
	inch	mm		inch	mm	inch	mm	inch	mm	
17743-4-6	1/4	7/16x20	3/8	2.28	58	0.33	8	9/16	1.25	32

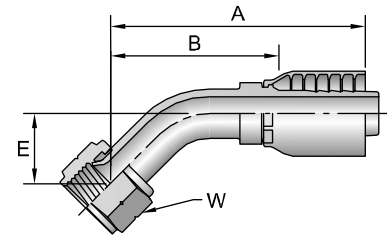

17 43

Female SAE 45° - Swivel - 0° Elbow

# Part Number	Thread		Hose I.D. inch	A		E		B		
	inch	mm		inch	mm	inch	mm	inch	mm	
17943-6-6	3/8	5/8x18	3/8	2.13	54	0.85	22	3/4	1.13	29

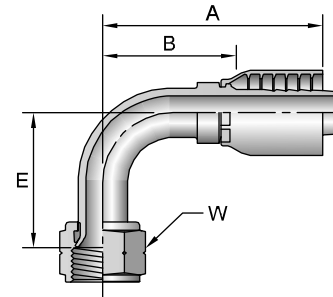

11143

Male Ferulok Flareless - Rigid
(24° Cone with Nut and Ferrule)

# Part Number	Thread		Hose I.D. inch	A		H		B	
	inch	mm		inch	mm	inch	mm	inch	mm
11143-4-4	1/4	7/16x20	1/4	2.13	54	9/16	9/16	1.40	36
11143-4-6	1/4	7/16x20	3/8	2.44	62	3/4	9/16	1.44	37
11143-5-4	5/16	1/2x20	1/4	2.13	54	9/16	5/8	1.40	36
11143-5-6	5/16	1/2x20	3/8	2.44	62	3/4	5/8	1.44	37
11143-6-6	3/8	9/16x18	3/8	2.50	64	3/4	11/16	1.50	38
11143-8-8	1/2	3/4x16	1/2	2.93	74	7/8	7/8	1.68	43
11143-10-8	5/8	7/8x14	1/2	3.07	78	15/16	1	1.82	46
11143-12-12	3/4	1-1/16x12	3/4	3.39	86	1-1/8	1-1/4	1.96	50
11143-16-16	1	1-5/16x12	1	3.80	97	1-3/8	1-1/2	2.18	55

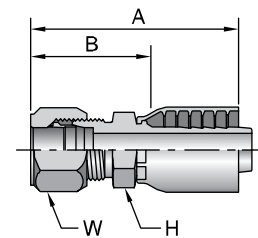

The Parker Ferrul-Fix fitting makes it possible to salvage the bent tube section from a hose assembly for quick, easy on-the-job repairs. For additional information see Ferrule-Fix installation instructions in the Technical Section.

Notch on nut signifies SAE 45 flare.

Hose
A
 Fittings
 43 Series
B
 Equipment
C
 Accessories
D
 Technical
E

11243

Female Ferulok Flareless - Swivel - (24° Cone)

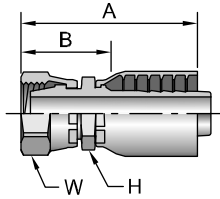

# Part Number	Thread		Hose I.D. inch	A		H		B	
	inch	inch		inch	mm	inch	inch	inch	mm
11243-6-6	3/8	9/16x18	3/8	2.51	64	11/16	11/16	1.48	38
11243-8-6	1/2	3/4x16	3/8	2.67	68	7/8	7/8	1.64	42
11243-8-8	1/2	3/4x16	1/2	2.89	73	7/8	7/8	1.63	41

1 J43

Female Ferulok Connection - SPL - PTF Taper Thread
 Rigid - 1 2 x 27

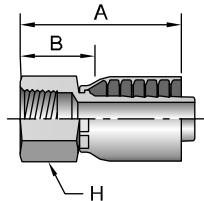

# Part Number	Thread		Hose I.D. inch	A		H		B	
	inch	inch		inch	mm	inch	inch	inch	mm
1 J43-4-4	1/2x27	1/4	1.79	45	3/4	1.04	26		
1 J43-4-6	1/2x27	3/8	2.05	52	3/4	1.02	26		

12843

Male Inverted SAE 45° - Swivel

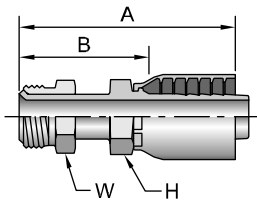

# Part Number	Thread		Hose I.D. inch	A		H		B	
	inch	inch		inch	mm	inch	inch	inch	mm
12843-4-4	1/4	7/16x24	1/4	2.32	59	9/16	7/16	1.57	40
12843-4-6	1/4	7/16x24	3/8	2.65	67	11/16	7/16	1.62	41
12843-5-4	5/16	1/2x20	1/4	2.60	66	9/16	1/2	1.85	47
12843-5-6	5/16	1/2x20	3/8	2.74	70	11/16	1/2	1.71	43
12843-6-6	3/8	5/8x18	3/8	2.86	73	11/16	5/8	1.83	46
12843-7-6	7/16	11/16x18	3/8	2.95	75	11/16	11/16	1.92	49
12843-8-8	1/2	3/4x18	1/2	3.11	79	13/16	3/4	1.85	47
12843-10-10	5/8	7/8x18	5/8	3.55	90	3/4	7/8	2.11	54

16743

Male Inverted SAE 45° - Swivel - 45° Elbow

# Part Number	Thread		Hose I.D. inch	A		E		inch	B	
	inch	mm		inch	mm	inch	mm		inch	mm
16743-4-4	1/4	7/16x24	1/4	2.09	53	0.63	16	7/16	1.34	34
16743-4-6	1/4	7/16x24	3/8	2.42	61	0.63	16	7/16	1.39	35
16743-5-4	5/16	1/2x20	1/4	2.34	59	0.70	18	1/2	1.59	40
16743-5-6	5/16	1/2x20	3/8	2.48	63	0.70	18	1/2	1.45	37
16743-6-6	3/8	5/8x18	3/8	2.93	74	0.94	24	5/8	1.90	48
16743-8-8	1/2	3/4x18	1/2	3.23	82	1.09	28	3/4	1.97	50

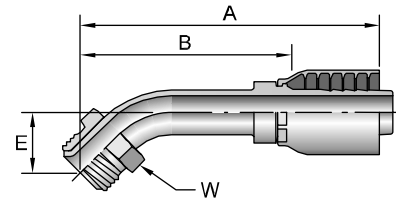

16 43

Male Inverted SAE 45° - Swivel - 0° Elbow

# Part Number	Thread		Hose I.D. inch	A		E		inch	B	
	inch	mm		inch	mm	inch	mm		inch	mm
16943-4-4	1/4	7/16x24	1/4	2.16	55	1.56	40	7/16	1.41	36
16943-4-6	1/4	7/16x24	3/8	2.49	63	1.56	40	7/16	1.46	37
16943-5-4	5/16	1/2x20	1/4	2.41	61	1.65	42	1/2	1.66	42
16943-5-6	5/16	1/2x20	3/8	2.59	66	1.65	42	1/2	1.56	40
16943-6-6	3/8	5/8x18	3/8	2.61	66	1.69	43	5/8	1.58	40
16943-7-6	7/16	11/16x18	3/8	2.53	64	1.72	44	11/16	1.50	38
16943-8-8	1/2	3/4x18	1/2	2.81	71	1.88	48	3/4	1.55	39

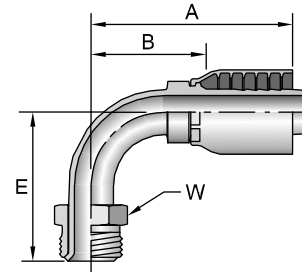

11543

SAE Code 61 Flange Head
ISO 12151-3 - S - L

# Part Number	Flange inch	Hose I.D. inch	A		F inch	B	
			inch	mm		inch	mm
11543-8-8	1/2	1/2	3.48	88	1-3/16	2.22	56
11543-10-10	5/8	5/8	3.78	96,0	1-11/32	2.34	59,4
11543-12-8	3/4	1/2	2.46	62,5	1-1/2	1.20	30,5
11543-12-12	3/4	3/4	3.54	90	1-1/2	2.10	53
11543-16-12	1	3/4	2.74	70	1-3/4	1.30	33
11543-16-16	1	1	4.25	108	1-3/4	2.63	67
11543-20-16	1-1/4	1	3.19	81	2	1.57	40
11543-20-20	1-1/4	1-1/4	4.70	119	2	3.01	76
11543-24-20	1-1/2	1-1/4	3.22	82	2-3/8	1.53	39
11543-24-24	1-1/2	1-1/2	4.59	117	2-3/8	3.22	82
11543-24-32	1-1/2	2	5.65	144	2-7/8	3.87	98
11543-32-20	2	1-1/4	4.29	109,0	2-13/16	2.60	66,0
11543-32-24	2	1-1/2	3.14	80	2-7/8	1.77	45
11543-32-32	2	2	4.99	127	2-13/16	3.21	82

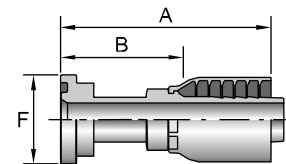

Must be assembled with a Superkrimp or Parkrimp 2.
See Accessories Section for O-Rings and Flange its.

Hose
A

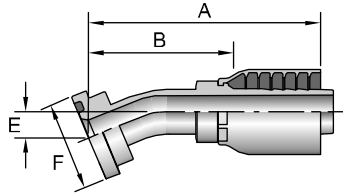

11643

SAE Code 61 Flange Head - 22-1° Elbow
ISO 12151-3 - E22M - L

# Part Number	Flange inch	Hose I.D. inch	A		E		F inch	B	
			inch	mm	inch	mm		inch	mm
11643-12-12	3/4	3/4	3.90	99	0.44	11	1-1/2	2.47	63
11643-16-12	1	3/4	3.89	99	0.44	11	1-3/4	2.46	62
11643-16-16	1	1	4.25	108	0.44	11	1-3/4	2.66	68
11643-20-16	1-1/4	1	4.25	108	0.44	11	2	2.66	68
11643-20-20	1-1/4	1-1/4	4.65	118	0.50	13	2	3.00	76
11643-24-20	1-1/2	1-1/4	4.66	118	0.51	13	2-3/8	3.01	76

Fittings
43 Series
B

12643

SAE Code 61 Flange Head - 30° Elbow
ISO 12151-3 - E30S - L (1 Piece: ISO 12151-3 - E30M - L)

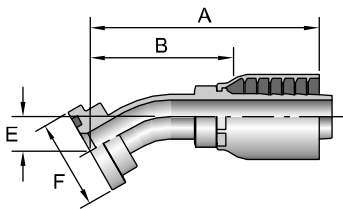

# Part Number	Flange inch	Hose I.D. inch	A		E		F inch	B	
			inch	mm	inch	mm		inch	mm
12643-12-12	3/4	3/4	3.90	99	0.59	15	1-1/2	2.46	62
12643-16-16	1	1	4.38	111	0.62	16	1-3/4	2.76	70
12643-20-16	1-1/4	1	4.38	111	0.62	16	2	2.76	70
12643-20-20	1-1/4	1-1/4	4.39	112	0.72	18	2	2.70	69

Equipment
C

11743

SAE Code 61 Flange Head - 45° Elbow
ISO 12151-3 - E45S - L (1 Piece: ISO 12151-3 - E45M - L)

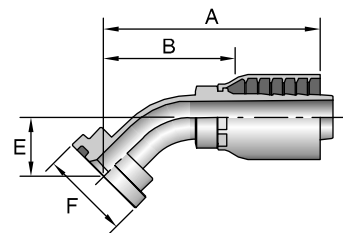

# Part Number	Flange inch	Hose I.D. inch	A		E		F inch	B	
			inch	mm	inch	mm		inch	mm
11743-8-8	1/2	1/2	3.28	83	0.77	20	1-3/16	2.02	51
11743-10-10	5/8	5/8	4.63	118	0.94	24	1-11/32	3.19	81
11743-12-8	3/4	1/2	3.32	84	0.81	21	1-1/2	2.06	52
11743-12-12	3/4	3/4	3.85	98	1.02	26	1-1/2	2.41	61
11743-16-12	1	3/4	3.85	98	1.02	26	1-3/4	2.41	61
11743-16-16	1	1	4.76	121	1.26	32	1-3/4	3.14	80
11743-20-16	1-1/4	1	4.76	121	1.26	32	2	3.14	80
11743-20-20	1-1/4	1-1/4	5.61	142	1.50	38	2	3.92	100
11743-20-24	1-1/4	1-1/2	5.45	138	1.38	35	2	4.08	104
11743-24-20	1-1/2	1-1/4	5.55	141	1.496	38	2-3/8	3.86	98
11743-24-24	1-1/2	1-1/2	5.50	140	1.43	36	2-3/8	4.13	105
11743-32-24	2	1-1/2	5.49	139	1.42	36	2-13/16	4.12	105
11743-32-32	2	2	7.23	184	1.98	50	2-13/16	5.45	138

Accessories
D

Technical
E

Must be assembled with Die Part No. 83C-A20H in a Superkrimp or Parkrimp 2.
See Accessories Section for O-Rings and Flange its.



12743

SAE Code 61 Flange Head - 60° Elbow
ISO 12151-3 - E60S - L (1 Piece: ISO 12151-3 - E60M - L)

# Part Number	Flange inch	Hose I.D. inch	A		E		F	B	
			inch	mm	inch	mm		inch	mm
12743-12-12	3/4	3/4	4.16	105	1.43	36	1-1/2	2.72	69
12743-16-12	1	3/4	4.15	105	1.39	35	1-3/4	2.71	69
12743-16-16	1	1	4.45	113	1.50	38	1-3/4	2.83	72
12743-20-20	1-1/4	1-1/4	5.09	129	1.69	43	2	3.40	86

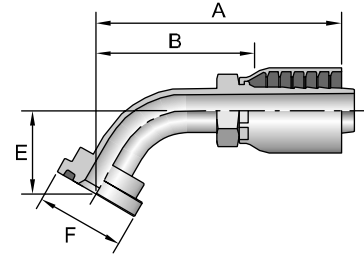

11843

SAE Code 61 Flange Head - 67-1 2° Elbow
ISO 12151-3 - E67S - L (1 Piece: ISO 12151-3 - E67M - L)

# Part Number	Flange inch	Hose I.D. inch	A		E		F	B	
			inch	mm	inch	mm		inch	mm
11843-12-12	3/4	3/4	4.09	104	1.60	41	1-1/2	2.66	68
11843-16-16	1	1	4.66	118	1.75	44	1-3/4	3.07	78
11843-20-20	1-1/4	1-1/4	5.04	128	1.94	49	2	3.37	86

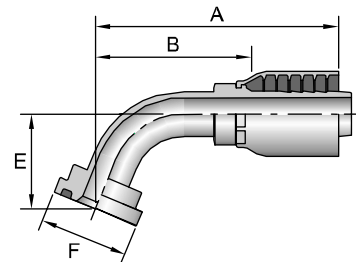

11 43

SAE Code 61 Flange Head - 0° Elbow
ISO 12151-3 - E90S - L (1 Piece: ISO 12151-3 - E90M - L)

# Part Number	Flange inch	Hose I.D. inch	A		E		F	B	
			inch	mm	inch	mm		inch	mm
11943-8-8	1/2	1/2	2.93	74	1.60	41	1-3/16	1.67	42
11943-10-10	5/8	5/8	3.71	94	2.10	53	1-11/32	2.27	58
11943-12-8	3/4	1/2	2.93	74	1.66	42	1-1/2	1.67	42
11943-12-10	3/4	5/8	3.71	94	2.10	53	1-1/2	2.27	58
11943-12-12	3/4	3/4	3.51	89	2.28	58	1-1/2	2.07	53
11943-16-8	1	1/2	2.91	74	2.03	52	1-3/4	1.65	42
11943-16-12	1	3/4	3.52	89	2.28	58	1-3/4	1.92	53
11943-16-16	1	1	4.28	109	2.78	71	1-3/4	2.66	68
11943-20-16	1-1/4	1	4.25	108	2.76	70	2	2.63	67
11943-20-20	1-1/4	1-1/4	5.12	130	3.54	90	2	3.43	87
11943-24-20	1-1/2	1-1/4	5.09	129	3.54	90	2-3/8	3.40	86
11943-20-24	1-1/4	1-1/2	4.19	106	2.49	63	2	2.82	72
11943-24-24	1-1/2	1-1/2	5.50	140	3.11	79	2-3/8	4.13	105
11943-32-24	2	1-1/2	5.48	139	3.10	79	2-13/16	4.11	104
11943-32-32	2	2	6.75	171	4.48	114	2-13/16	4.97	126

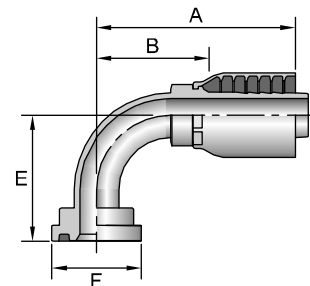

Can not be assembled with carry rimp.
Must be assembled with Die Part No. 83C-A20H in a Superkrimp or Parkrimp 2.
See Accessories Section for O-Rings and Flange its.

Hose
A
 Fittings
 43 Series
B
 Equipment
C
 Accessories
D
 Technical
E

1J043

Male Seal-Lok - Rigid - (with -Ring)
ISO 12151-1 - S

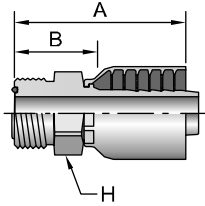

# Part Number	Thread		Hose I.D. inch	A		H inch	B	
	inch	mm		inch	mm		inch	mm
1J043-4-4	1/4	9/16x18	1/4	1.73	44	5/8	0.98	25
1J043-6-6	3/8	11/16x16	3/8	2.08	53	3/4	1.05	27
1J043-8-6	1/2	13/16x16	3/8	2.20	56	7/8	1.17	30
1J043-8-8	1/2	13/16x16	1/2	2.42	61	7/8	1.17	30
1J043-10-8	5/8	1x14	1/2	2.61	66	1-1/16	1.35	34
1J043-10-10	5/8	1x14	5/8	2.73	69	1-1/16	1.34	34
1J043-12-10	3/4	1-3/16x12	5/8	2.89	73	1-1/4	1.45	37
1J043-12-12	3/4	1-3/16x12	3/4	2.90	74	1-1/4	1.46	37
1J043-16-12	1	1-7/16x12	3/4	2.93	74	1-1/2	1.49	38
1J043-16-16	1	1-7/16x12	1	3.29	84	1-1/2	1.67	42
1J043-20-20	1-1/4	1-11/16x12	1-1/4	3.32	84	1-3/4	1.63	41

1JB43

Male Seal-Lok - Bulkhead without Locknut - (with -Ring)
ISO 8434-3 - BH

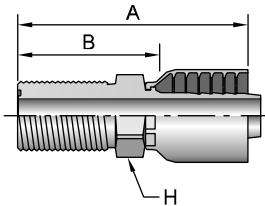

# Part Number	Thread		Hose I.D. inch	A		H inch	B	
	inch	mm		inch	mm		inch	mm
1JB43-4-4	1/4	9/16x18	1/4	2.58	66	5/8	1.83	46
1JB43-6-6	3/8	11/16x16	3/8	2.98	76	3/4	1.95	50
1JB43-8-6	1/2	13/16x16	3/8	3.41	87	7/8	2.38	60
1JB43-8-8	1/2	13/16x16	1/2	3.36	85	7/8	2.10	53
1JB43-10-8	5/8	1x14	1/2	3.58	91	1-1/16	2.32	59
1JB43-10-10	5/8	1x14	5/8	3.77	96	1-1/16	2.33	59
1JB43-12-12	3/4	1-3/16x12	3/4	3.87	98	1-1/4	2.43	62

Fittings are stocked less locknut (part no. WLN). Locknuts are manufactured by the Parker Tube Fittings Division and must be ordered separately.

See Accessories Section for O-Rings and Flange its.



1JC43

Female Seal-Lok - Swivel - Short
ISO 12151-1 - SWSA

# Part Number	Thread		Hose I.D. inch	A		C		H		B		Additional Material Stainless Steel (C)
	inch	mm		inch	mm	inch	mm	inch	mm	inch	mm	
1JC43-4-4	1/4	9/16x18	1/4	1.63	41	0.32	8	9/16	11/16	0.88	22	
1JC43-4-4-SM	1/4	9/16x18	1/4	1.63	41	0.32	8	17 mm	17 mm	0.88	22	
1JC43-4-6	1/4	9/16x18	3/8	1.90	48	0.32	8	11/16	11/16	0.87	22	
1JC43-6-4	3/8	11/16x16	1/4	1.67	42	0.32	8	11/16	13/16	0.92	23	
1JC43-6-4-SM	3/8	11/16x16	1/4	1.67	42	0.32	8	17 mm	22 mm	0.92	23	
1JC43-6-5	3/8	11/16x16	5/16	1.65	42	0.32	8	11/16	13/16	0.90	23	
1JC43-6-6	3/8	11/16x16	3/8	1.94	49	0.32	8	11/16	13/16	0.91	23	
1JC43-6-6-SM	3/8	11/16x16	3/8	1.94	49	0.32	8	19 mm	22 mm	0.91	23	
1JC43-8-6	1/2	13/16x16	3/8	2.00	51	0.43	11	13/16	15/16	0.97	25	
1JC43-8-6-SM	1/2	13/16x16	3/8	2.00	51	0.43	11	19 mm	24 mm	0.97	25	
1JC43-8-8	1/2	13/16x16	1/2	2.22	56	0.43	11	13/16	15/16	0.96	24	
1JC43-8-8-SM	1/2	13/16x16	1/2	2.22	56	0.43	11	22 mm	24 mm	0.96	24	
1JC43-10-8	5/8	1x14	1/2	2.30	58	0.53	13	15/16	1-1/8	1.04	26	
1JC43-10-8-SM	5/8	1x14	1/2	2.30	58	0.53	13	24 mm	30 mm	1.04	26	
1JC43-10-10	5/8	1x14	5/8	2.49	63	0.53	13	15/16	1-1/8	1.05	27	
1JC43-10-10-SM	5/8	1x14	5/8	2.49	63	0.53	13	24 mm	30 mm	1.05	27	
1JC43-12-8	3/4	1-3/16x12	1/2	2.48	63	0.57	14	1-1/8	1-3/8	1.22	31	
1JC43-12-10	3/4	1-3/16x12	5/8	2.67	68	0.57	14	1-1/8	1-3/8	1.23	31	
1JC43-12-10-SM	3/4	1-3/16x12	5/8	2.67	68	0.57	14	32 mm	36 mm	1.23	31	
1JC43-12-12	3/4	1-3/16x12	3/4	2.68	68	0.57	14	1-1/8	1-3/8	1.24	31	
1JC43-12-12-SM	3/4	1-3/16x12	3/4	2.68	68	0.57	14	32 mm	36 mm	1.24	31	
1JC43-12-16	3/4	1-3/16x12	1	2.99	76	0.57	14	1-5/16	1-3/8	1.37	35	
1JC43-16-12	1	1-7/16x12	3/4	2.83	72	0.58	15	1-3/8	1-5/8	1.39	35	
1JC43-16-16	1	1-7/16x12	1	3.14	80	0.58	15	1-3/8	1-5/8	1.52	39	
1JC43-20-20	1-1/4	1-11/16x12	1-1/4	3.27	83	0.59	15	1-7/8	1-7/8	1.58	40	

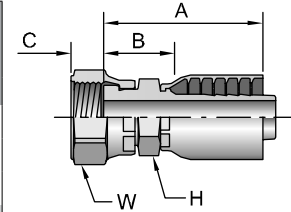

When measuring overall length to the end of the nut, B C dimensions must be used to calculate cut-off allowance.
Stainless steel fittings must be assembled with arraykrimp 2, PHastkrimp, Superkrimp or Parkrimp 2.
See CrimpSource for more information.

See Accessories Section for O-Rings.



B-

Hose Products Division
Parker Hannifin Corporation
Wickliffe, Ohio
www.parkerhose.com

Hose
A
Fittings 43 Series
B
Equipment
C
Accessories
D
Technical
E

A Hose
 B Fittings 43 Series
 C Equipment
 D Accessories
 E Technical

1JS43

Female Seal-Lok - Swivel - Long
ISO 12151-1 SWSB

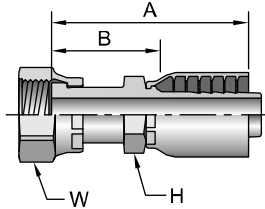

# Part Number	Thread		Hose I.D. inch	A		H		B	
	inch	inch		inch	mm	inch	inch	inch	mm
1JS43-4-4	1/4	9/16x18	1/4	2.07	53	9/16	11/16	1.32	34
1JS43-4-6	1/4	9/16x18	3/8	2.21	56	11/16	11/16	1.18	30
1JS43-6-4	3/8	11/16x16	1/4	2.14	54	9/16	13/16	1.39	35
1JS43-6-6	3/8	11/16x16	3/8	2.28	58	11/16	13/16	1.25	32
1JS43-6-8	3/8	11/16x16	1/2	2.50	64	13/16	13/16	1.24	31
1JS43-8-4	1/2	13/16x16	1/4	2.26	57	11/16	15/16	1.51	38
1JS43-8-6	1/2	13/16x16	3/8	2.53	64	11/16	15/16	1.50	38
1JS43-8-8	1/2	13/16x16	1/2	2.65	67	13/16	15/16	1.39	35
1JS43-8-10	1/2	13/16x16	5/8	2.82	72	15/16	15/16	1.38	35
1JS43-10-6	5/8	1x14	3/8	2.63	67	11/16	1-1/8	1.62	41
1JS43-10-8	5/8	1x14	1/2	2.89	73	13/16	1-1/8	1.63	41
1JS43-10-10	5/8	1x14	5/8	3.07	78	15/16	1-1/8	1.66	42
1JS43-10-12	5/8	1x14	3/4	3.08	78	1-1/16	1-1/8	1.64	42
1JS43-12-8	3/4	1-3/16x12	1/2	2.90	74	15/16	1-3/8	1.64	42
1JS43-12-10	3/4	1-3/16x12	5/8	3.19	81	1-1/8	1-3/8	1.75	44
1JS43-12-12	3/4	1-3/16x12	3/4	3.31	84	1-1/8	1-3/8	1.87	47
1JS43-12-16	3/4	1-3/16x12	1	3.53	90	1-5/16	1-3/8	1.91	49
1JS43-16-12	1	1-7/16x12	3/4	3.37	86	1-3/8	1-5/8	1.93	49
1JS43-16-16	1	1-7/16x12	1	3.62	92	1-3/8	1-5/8	2.00	51
1JS43-16-20	1	1-7/16x12	1-1/4	3.77	96	1-3/4	1-5/8	2.08	53
1JS43-20-16	1-1/4	1-11/16x12	1	3.64	92	1-3/8	1-7/8	2.02	51
1JS43-20-20	1-1/4	1-11/16x12	1-1/4	3.77	96	1-3/4	1-7/8	2.15	53
1JS43-24-20	1-1/2	2x12	1-1/4	3.88	99	1-3/4	2-1/4	2.23	57
1JS43-24-24	1-1/2	2x12	1-1/2	3.91	99	1-7/8	2-1/4	2.54	65

1J643

Female Seal-Lok - Swivel - 22-1 2° Elbow
ISO 8434-3

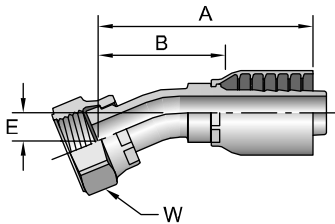

# Part Number	Thread		Hose I.D. inch	A		E		B		
	inch	inch		inch	mm	inch	mm			
1J643-8-8	1/2	13/16x16	1/2	3.06	78	0.39	10	15/16	1.80	46

See Accessories Section for O-Rings.



1J743

Female Seal-Lok - Swivel - 45° Elbow
ISO 12151-1 - SWE45

# Part Number	Thread		Hose I.D. inch	A		E		inch	B	
	inch	mm		inch	mm	inch	mm		inch	mm
1J743-4-4	1/4	9/16x18	1/4	1.97	50	0.39	10	11/16	1.22	31
1J743-4-4-SM	1/4	9/16x18	1/4	1.97	50	0.39	10	17 mm	1.22	31
1J743-4-6	1/4	9/16x18	3/8	2.23	57	0.39	10	11/16	1.20	30
1J743-6-4	3/8	11/16x16	1/4	2.08	53	0.43	11	13/16	1.33	34
1J743-6-4-SM	3/8	11/16x16	1/4	2.08	53	0.43	11	22 mm	1.33	34
1J743-6-5	3/8	11/16x16	5/16	2.37	60	0.43	11	13/16	1.62	41
1J743-6-6	3/8	11/16x16	3/8	2.34	59	0.43	11	13/16	1.31	33
1J743-6-8	3/8	11/16x16	1/2	2.66	68	0.43	11	13/16	1.41	36
1J743-8-4	1/2	13/16x16	1/4	2.56	65	0.59	15	15/16	1.81	46
1J743-8-6	1/2	13/16x16	3/8	2.53	64	0.59	15	15/16	1.50	38
1J743-8-6-SM	1/2	13/16x16	3/8	2.53	64	0.59	15	24 mm	1.50	38
1J743-8-8	1/2	13/16x16	1/2	2.83	72	0.59	15	15/16	1.57	40
1J743-8-8-SM	1/2	13/16x16	1/2	2.83	72	0.59	15	24 mm	1.57	40
1J743-8-10	1/2	13/16x16	5/8	3.09	78	0.59	15	15/16	1.65	42
1J743-10-8	5/8	1x14	1/2	2.93	74	0.63	16	1-1/8	1.67	42
1J743-10-10	5/8	1x14	5/8	3.17	81	0.63	16	1-1/8	1.73	44
1J743-10-10-SM	5/8	1x14	5/8	3.17	81	0.63	16	30 mm	1.73	44
1J743-10-12	5/8	1x14	3/4	3.36	85	0.65	16	1-1/8	1.93	49
1J743-12-8	3/4	1-3/16x12	1/2	3.57	91	0.82	21	1-3/8	2.31	59
1J743-12-10	3/4	1-3/16x12	5/8	3.62	92	0.83	21	1-3/8	2.18	55
1J743-12-12	3/4	1-3/16x12	3/4	3.63	92	0.83	21	1-3/8	2.19	56
1J743-12-12-SM	3/4	1-3/16x12	3/4	3.63	92	0.83	21	36 mm	2.19	56
1J743-12-16	3/4	1-3/16x12	1	3.67	93	0.81	21	1-3/8	2.05	52
1J743-16-12	1	1-7/16x12	3/4	4.02	102	0.94	24	1-5/8	2.59	66
1J743-16-16	1	1-7/16x12	1	4.38	111	0.94	24	1-5/8	2.76	70
1J743-16-20	1	1-7/16x12	1-1/4	4.59	117	0.94	24	1-5/8	2.94	75
1J743-20-16	1-1/4	1-11/16x12	1	4.52	115	1.00	25	1-7/8	2.93	74
1J743-20-20	1-1/4	1-11/16x12	1-1/4	4.78	121	1.00	25	1-7/8	3.09	78
1J743-24-20	1-1/2	2x12	1-1/4	4.99	127	1.11	28	2-1/4	3.30	84
1J743-24-24	1-1/2	2x12	1-1/2	4.70	119	1.07	27	2-1/4	3.33	85

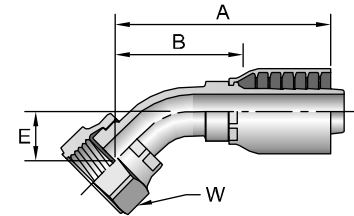

Hose
A

Fittings
43 Series
B

Equipment
C

Accessories
D

Technical
E

See Accessories Section for O-Rings.



B-

Hose Products Division
Parker Hannifin Corporation
Wickliffe, Ohio
www.parkerhose.com

Hose
A

Fittings
43 Series
B

Equipment
C

Accessories
D

Technical
E

1J 43

Female Seal-Lok - Swivel - 0° Elbow - Short Drop
ISO 12151-1 - SWES90

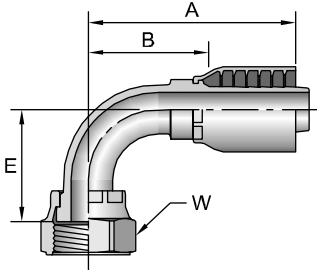

# Part Number	Thread		Hose I.D. inch	A		E		inch	B	
	inch	inch		inch	mm	inch	mm		inch	mm
1J943-4-4	1/4	9/16x18	1/4	1.78	45	0.83	21	11/16	1.03	26
1J943-4-6	1/4	9/16x18	3/8	2.05	52	0.83	21	11/16	1.02	26
1J943-6-4	3/8	11/16x16	1/4	1.93	49	0.91	23	13/16	1.18	30
1J943-6-5	3/8	11/16x16	5/16	2.25	57	0.90	23	13/16	1.50	38
1J943-6-6	3/8	11/16x16	3/8	2.21	56	0.91	23	13/16	1.18	30
1J943-6-8	3/8	11/16x16	1/2	2.53	64	0.90	23	13/16	1.27	32
1J943-8-4	1/2	13/16x16	1/4	2.28	58	1.15	29	15/16	1.53	39
1J943-8-6	1/2	13/16x16	3/8	2.28	58	1.14	29	15/16	1.25	32
1J943-8-8	1/2	13/16x16	1/2	2.59	66	1.14	29	15/16	1.33	34
1J943-8-8-SM	1/2	13/16x16	1/2	2.59	66	1.14	29	24 mm	1.33	34
1J943-8-10	1/2	13/16x16	5/8	2.81	71	1.15	29	15/16	1.37	35
1J943-10-8	5/8	1x14	1/2	2.74	70	1.26	32	1-1/8	1.48	38
1J943-10-10	5/8	1x14	5/8	2.97	75	1.26	32	1-1/8	1.53	39
1J943-10-10-SM	5/8	1x14	5/8	2.97	75	1.26	32	30 mm	1.53	39
1J943-10-12	5/8	1x14	3/4	3.08	78	1.27	32	1-1/8	1.64	42
1J943-12-8	3/4	1-3/16x12	1/2	3.21	82	1.89	48	1-3/8	1.95	50
1J943-12-10	3/4	1-3/16x12	5/8	3.49	89	1.89	48	1-3/8	2.05	52
1J943-12-12	3/4	1-3/16x12	3/4	3.06	78	1.89	48	1-3/8	2.05	52
1J943-12-16	3/4	1-3/16x12	1	3.88	99	1.89	48	1-3/8	2.26	57
1J943-16-12	1	1-7/16x12	3/4	4.06	103	2.22	56	1-5/8	2.62	67
1J943-16-16	1	1-7/16x12	1	4.31	109	2.20	56	1-5/8	2.69	68
1J943-16-20	1	1-7/16x12	1-1/4	4.56	116	2.21	56	1-5/8	2.87	73
1J943-20-16	1-1/4	1-11/16x12	1	4.64	118	2.54	65	1-7/8	3.02	80
1J943-20-20	1-1/4	1-11/16x12	1-1/4	4.88	124	2.51	64	1-7/8	3.19	81
1J943-24-20	1-1/2	2x12	1-1/4	4.97	126	2.70	69	2-1/4	3.32	84
1J943-24-24	1-1/2	2x12	1-1/2	5.50	140	2.68	68	2-1/4	4.13	105

1J543

Female Seal-Lok - Swivel - 0° Elbow - Medium Drop
ISO 12151-1 - SWSB

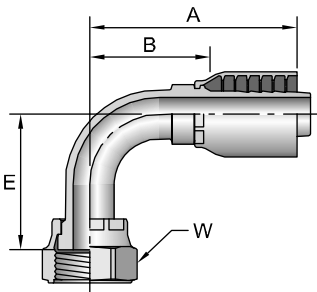

# Part Number	Thread		Hose I.D. inch	A		E		inch	B	
	inch	inch		inch	mm	inch	mm		inch	mm
1J543-4-4	1/4	9/16x18	1/4	2.07	53	1.26	32	11/16	1.32	34
1J543-6-4	3/8	11/16x16	1/4	2.12	54	1.50	38	13/16	1.37	35
1J543-6-6	3/8	11/16x16	3/8	2.40	61	1.50	38	13/16	1.37	35
1J543-6-6-SM	3/8	11/16x16	3/8	2.40	61	1.50	38	22 mm	1.37	35
1J543-8-6	1/2	13/16x16	3/8	2.48	63	1.61	41	15/16	1.45	37
1J543-8-8	1/2	13/16x16	1/2	2.59	66	1.61	41	15/16	1.33	34
1J543-10-8	5/8	1x14	1/2	2.74	70	1.85	47	1-1/8	1.48	38
1J543-10-10	5/8	1x14	5/8	2.97	75	1.85	47	1-1/8	1.53	39
1J543-10-12	5/8	1x14	3/4	3.12	79	1.88	48	1-1/8	1.68	43
1J543-12-12	3/4	1-3/16x12	3/4	3.49	89	2.28	58	1-3/8	2.05	52
1J543-16-16	1	1-7/16x12	1	4.86	123	2.78	71	1-5/8	3.27	83
1J543-20-20	1-1/4	1-11/16x12	1-1/4	4.89	124	3.09	78	1-7/8	3.20	81

See Accessories Section for O-Rings.



1J143

Female Seal-Lok - Swivel - 0° Elbow - Long Drop
ISO 12151-1 - SWEL90

# Part Number	Thread		Hose I.D. inch	A		E		B		
	inch	mm		inch	mm	inch	mm	inch	mm	mm
1J143-4-4	1/4	9/16x18	1/4	2.02	51	1.81	46	11/16	1.27	32
1J143-6-4	3/8	11/16x16	1/4	2.26	57	2.29	58	13/16	1.51	38
1J143-6-6	3/8	11/16x16	3/8	2.39	61	2.13	54	13/16	1.36	35
1J143-8-6	1/2	13/16x16	3/8	2.45	62	2.52	64	15/16	1.42	36
1J143-8-8	1/2	13/16x16	1/2	2.59	66	2.52	64	15/16	1.33	34
1J143-8-8-SM	1/2	13/16x16	1/2	2.59	66	2.52	64	24 mm	1.33	34
1J143-10-8	5/8	1x14	1/2	2.74	70	2.79	71	1-1/8	1.48	38
1J143-10-10	5/8	1x14	5/8	2.97	75	2.76	70	1-1/8	1.53	39
1J143-10-12	5/8	1x14	3/4	3.15	80	2.76	70	1-1/8	1.73	44
1J143-12-12	3/4	1-3/16x12	3/4	3.49	89	3.78	96	1-3/8	2.05	52
1J143-16-16	1	1-7/16x12	1	4.28	109	4.49	114	1-5/8	2.66	68
1J143-20-20	1-1/4	1-11/16x12	1-1/4	4.84	123	5.09	129	1-7/8	3.15	80
1J143-24-20	1-1/2	2x12	1-1/4	4.77	121	5.54	141	2-1/4	3.12	79

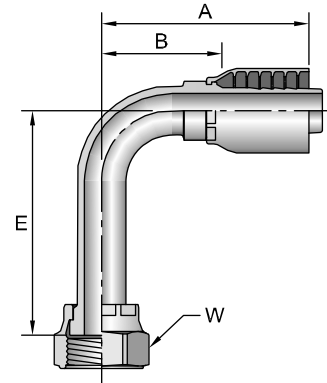

1D043

Male Metric L - Rigid - (24° Cone)
ISO 8434-1

# Part Number	Thread		Hose I.D. inch	A		H mm	B	
	mm	mm		inch	mm		inch	mm
1D043-6-4	6	M12x1,5	1/4	1.73	44	14	0.93	24
1D043-8-4	8	M14x1,5	1/4	1.61	41	14	0.93	24
1D043-10-5	10	M16x1,5	5/16	1.97	50	19	0.83	21
1D043-10-6	10	M16x1,5	3/8	1.97	50	19	0.83	21
1D043-12-5	12	M18x1,5	5/16	1.89	48	19	0.94	24
1D043-12-6	12	M18x1,5	3/8	1.97	50	19	0.83	21
1D043-15-6	15	M22x1,5	3/8	1.93	49	22	1.02	26
1D043-15-8	15	M22x1,5	1/2	2.28	58	22	0.94	24
1D043-18-10	18	M26x1,5	5/8	2.68	68	27	1.14	29
1D043-18-12	18	M26x1,5	3/4	2.68	68	27	1.14	29
1D043-22-12	22	M30x2	3/4	2.72	69	30	1.22	31
1D043-28-16	28	M36x2	1	3.11	79	36	1.30	33
1D043-35-20	35	M45x2	1-1/4	3.35	85	46	1.50	38

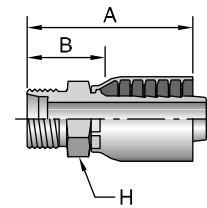

11D43

Male Standpipe Metric L - Rigid
ISO 8434-1

# Part Number	R mm	Hose I.D. inch	A		D		B	
			inch	mm	inch	mm	inch	mm
11D43-6-4	6	1/4	2.03	52	0.87	22	1.28	33
11D43-10-5	10	5/16	2.36	60	0.91	23	1.45	37
11D43-10-6	10	3/8	2.28	58	0.91	23	1.14	29
11D43-12-4	12	1/4	2.17	55	0.91	23	1.22	31
11D43-15-8	15	1/2	2.56	65	0.98	25	1.22	31
11D43-18-10	18	5/8	2.99	76	1.02	26	1.48	38
11D43-18-12	18	3/4	2.80	71	1.02	26	1.22	31
11D43-22-12	22	3/4	2.87	73	1.10	28	1.26	32
11D43-28-16	28	1	3.31	84	1.18	30	1.46	37

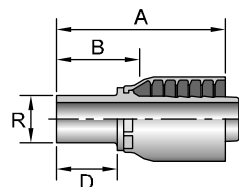

Metric L: Mates with EO "L" Series Fittings. See Accessories Section for O-Rings.



Hose

A

Fittings
43 Series

B

Equipment

C

Accessories

D

Technical

E

Hose
A

Fittings
43 Series
B

Equipment
C

Accessories
D

Technical
E

1C343

Female Metric L - Swivel - (Ball Nose)
ISO 8434-1

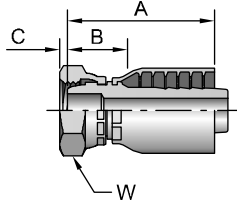

# Part Number	Thread		Hose I.D.	A		C		mm	B	
	mm	mm	inch	inch	mm	inch	mm		inch	mm
1C343-6-4	6	M12x1,5	1/4	1.75	44	0.09	2	14	1.16	29
1C343-8-4	8	M14x1,5	1/4	1.77	45	0.11	3	17	1.16	29
1C343-10-5	10	M16x1,5	5/16	2.01	51	0.06	2	19	1.20	30
1C343-10-6	10	M16x1,5	3/8	2.06	52	0.06	2	19	1.10	28
1C343-12-5	12	M18x1,5	5/16	1.87	47	0.10	3	22	0.70	18
1C343-12-6	12	M18x1,5	3/8	2.23	57	0.10	3	22	1.18	30
1C343-15-6	6	M22x1,5	3/8	1.85	47	0.16	4	27	0.71	18
1C343-15-8	15	M22x1,5	1/2	2.42	61	0.17	4	27	1.29	33
1C343-18-10	18	M26x1,5	5/8	2.65	67	0.10	3	32	1.23	31
1C343-18-12	18	M26x1,5	3/4	2.80	71	0.10	3	32	1.37	35
1C343-22-12	22	M30x2	3/4	2.87	73	0.18	5	36	1.42	36
1C343-28-16	28	M36x2	1	3.35	85	0.22	6	46	1.76	45

When measuring overall length to the end of the nut, B C dimensions must be used to calculate cut-off allowance.

1C443

Female Metric L - Swivel - 45° Elbow - (Ball Nose)
ISO 8434-1

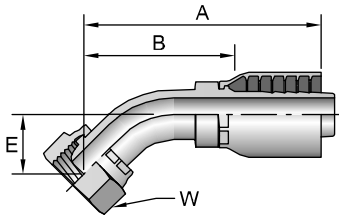

# Part Number	Thread		Hose I.D.	A		E		mm	B	
	mm	mm	inch	inch	mm	inch	mm		inch	mm
1C443-8-4	8	M14x1,5	1/4	2.40	61	0.59	15	17	1.50	38
1C443-10-5	10	M16x1,5	5/16	2.60	66	0.67	17	19	1.61	41
1C443-10-6	10	M16x1,5	3/8	2.76	70	0.67	17	19	1.61	41
1C443-12-6	12	M18x1,5	3/8	2.76	70	0.67	17	22	1.61	41
1C443-15-8	15	M22x1,5	1/2	3.35	85	0.79	20	27	1.97	50
1C443-18-10	18	M26x1,5	5/8	4.09	104	1.14	29	32	2.52	64
1C443-22-12	22	M30x2	3/4	3.78	96	0.91	23	36	2.20	56
1C443-28-16	28	M36x2	1	4.53	115	1.10	28	46	2.81	71

1C543

Female Metric L - Swivel - 0° Elbow - (Ball Nose)
ISO 8434-1

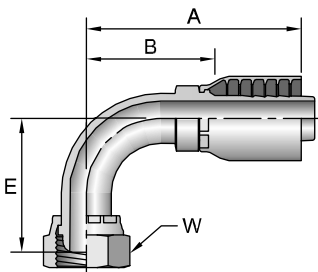

# Part Number	Thread		Hose I.D.	A		E		mm	B	
	mm	mm	inch	inch	mm	inch	mm		inch	mm
1C543-8-4	8	M14x1,5	1/4	2.05	52	1.10	28	17	1.18	30
1C543-10-5	10	M16x1,5	5/16	2.20	56	1.18	30	19	1.22	31
1C543-10-6	10	M16x1,5	3/8	2.40	61	1.18	30	19	1.40	36
1C543-12-6	12	M18x1,5	3/8	2.40	61	1.22	31	22	1.40	36
1C543-15-8	15	M22x1,5	1/2	2.95	75	1.57	40	27	1.57	40
1C543-18-10	18	M26x1,5	5/8	3.58	91	2.36	60	32	2.05	52
1C543-22-12	22	M30x2	3/4	3.58	91	1.97	50	36	2.00	51
1C543-28-16	28	M36x2	1	4.33	110	2.48	63	46	2.56	65

Metric L: Mates with EO "L" Series Fittings.

1CA43

Female Metric L - Swivel - (24° Cone with -Ring)
ISO 12151-2 - SWS

# Part Number	Thread mm	Hose I.D. inch	A		C		B		
			inch	mm	inch	mm	inch	mm	mm
1CA43-6-4	6	M12x1,5	1/4	1.81	46	-0.02	14	1.06	27
1CA43-8-4	8	M14x1,5	1/4	1.68	43	-0.01	17	0.88	22
1CA43-8-5	8	M14x1,5	5/16	2.01	51	0.00	17	1.02	26
1CA43-10-4	10	M16x1,5	1/4	1.81	46	0.04	19	0.87	22
1CA43-10-5	10	M16x1,5	5/16	1.73	44	0.04	19	0.82	21
1CA43-12-5	12	M18x1,5	5/16	1.81	46	0.04	22	0.91	23
1CA43-12-6	12	M18x1,5	3/8	2.17	55	0.03	22	1.02	26
1CA43-15-8	15	M22x1,5	1/2	2.52	64	0.07	27	1.14	29
1CA43-18-10	18	M26x1,5	5/8	3.02	77	0.02	32	1.61	41
1CA43-18-12	18	M26x1,5	3/4	2.56	65	0.02	32	1.11	28
1CA43-22-12	22	M30x2	3/4	2.83	72	0.13	36	1.30	33
1CA43-28-16	28	M36x2	1	3.35	85	0.14	46	1.57	40
1CA43-35-20	35	M45x2	1-1/4	3.28	83	0.00	50	1.55	39

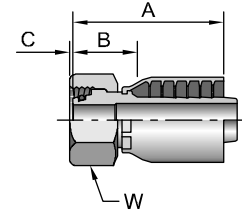

When measuring overall length to the end of the nut, B C dimensions must be used to calculate cut-off allowance.

1CE43

Female Metric L - Swivel - 45° Elbow - (24° Cone with -Ring)
ISO 12151-2 - SWE45

# Part Number	Thread mm	Hose I.D. inch	A		E		mm	B	
			inch	mm	inch	mm		inch	mm
1CE43-6-4	6	M12x1,5	1/4	2.76	70	0.75	19	1.81	46
1CE43-8-4	8	M14x1,5	1/4	2.32	59	0.63	16	1.38	35
1CE43-10-5	10	M16x1,5	5/16	2.64	67	0.63	16	1.73	44
1CE43-10-6	10	M16x1,5	3/8	3.43	87	0.73	19	2.44	62
1CE43-12-6	12	M18x1,5	3/8	2.87	73	0.87	22	1.73	44
1CE43-15-8	15	M22x1,5	1/2	3.39	86	0.87	22	2.00	51
1CE43-18-10	18	M26x1,5	5/8	3.58	91	0.98	25	2.05	52
1CE43-22-12	22	M30x2	3/4	3.82	97	0.98	25	2.28	58

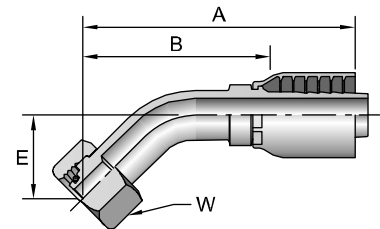

1CF43

Female Metric L - Swivel - 0° Elbow - (24° Cone with -Ring)
ISO 12151-2 - SWE

# Part Number	Thread mm	Hose I.D. inch	A		E		mm	B	
			inch	mm	inch	mm		inch	mm
1CF43-8-4	8	M14x1,5	1/4	2.01	51	1.14	29	1.10	28
1CF43-10-5	10	M16x1,5	5/16	2.3	58	1.16	29	1.46	37
1CF43-10-6	10	M16x1,5	3/8	2.56	65	1.38	35	1.58	40
1CF43-12-5	12	M18x1,5	5/16	2.40	61	1.18	30	1.46	37
1CF43-12-6	12	M18x1,5	3/8	2.40	61	1.22	31	1.40	36
1CF43-15-8	15	M22x1,5	1/2	2.95	75	1.65	42	1.57	40
1CF43-18-10	18	M26x1,5	5/8	3.17	81	1.77	45	1.71	43
1CF43-22-12	22	M30x2	3/4	3.54	90	2.09	53	2.00	51
1CF43-35-20	35	M45x2	1-1/4	4.72	120	3.11	79	2.87	73

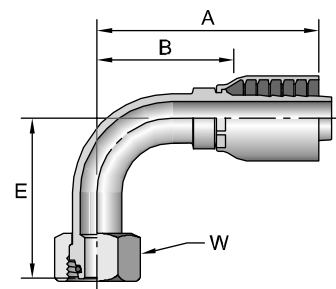

Metric L: Mates with EO "L" Series Fittings.



Hose
A
Fittings
43 Series
B
Equipment
C
Accessories
D
Technical
E

Hose
A

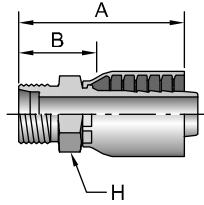

1D243
Male Metric S - Rigid - (24° Cone)
ISO 8434-1

# Part Number	Thread mm	Hose I.D. inch	A		H mm	B		
			inch	mm		inch	mm	
1D243-8-4	8	M16x1,5	1/4	1.73	44	17	0.87	22
1D243-10-4	10	M18x1,5	1/4	1.73	44	19	0.87	22
1D243-12-5	12	M20x1,5	5/16	2.20	56	22	1.29	33
1D243-12-6	12	M20x1,5	3/8	1.97	50	22	1.02	26
1D243-14-6	14	M22x1,5	3/8	2.17	55	22	0.98	25
1D243-16-8	16	M24x1,5	1/2	2.36	60	24	1.17	30
1D243-20-10	20	M30x2	5/8	2.95	75	30	1.44	37
1D243-25-12	25	M36x2	3/4	2.87	73	36	1.30	33
1D243-30-16	30	M42x2	1	3.39	86	46	1.54	39

Fittings
43 Series
B

13D43
Male Standpipe Metric S - Rigid
ISO 8434-1

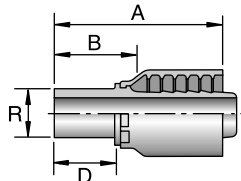

# Part Number	R mm	Hose I.D. inch	A		D		B	
			inch	mm	inch	mm	inch	mm
13D43-10-4	10	1/4	2.13	54	1.02	26	1.26	32
13D43-12-5	12	5/16	2.52	64	1.02	26	1.61	41
13D43-14-6	14	3/8	2.52	64	1.14	29	1.38	35
13D43-16-8	16	1/2	2.68	68	1.18	30	1.42	36
13D43-20-10	20	5/8	3.39	86	1.42	36	1.88	48
13D43-20-12	20	3/4	3.19	81	1.42	36	1.57	40
13D43-25-12	25	3/4	3.35	85	1.57	40	1.73	44
13D43-30-16	30	1	3.82	97	1.73	44	2.01	51

Light Series 11D43-6-4, 11D43-8-4 and 11D43-12-6 are used in place of their Heavy Series equivalent size and accept the EO Heavy "S" Series ferrules and nuts.

Equipment
C

1C643
Female Metric S - Swivel - (Ball Nose)
ISO 8434-1

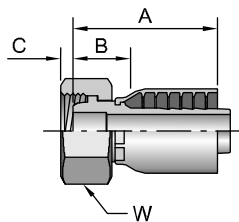

# Part Number	Thread mm	Hose I.D. inch	A		C		H mm	B		
			inch	mm	inch	mm		inch	mm	
1C643-8-4	8	M16x1,5	1/4	1.57	40	0.15	4	19	1.20	30
1C643-10-4	10	M18x1,5	1/4	1.63	41	0.10	3	22	1.20	30
1C643-12-5	12	M20x1,5	5/16	1.87	47	0.08	2	24	1.20	30
1C643-12-6	12	M20x1,5	3/8	1.76	45	0.08	2	24	1.32	34
1C643-12-8	12	M20x1,5	1/2	2.18	55	0.08	2	24	1.30	33
1C643-14-6	14	M22x1,5	3/8	1.94	49	0.17	4	27	1.32	34
1C643-16-8	16	M24x1,5	1/2	2.13	54	0.19	5	30	1.39	35
1C643-20-10	20	M30x2	5/8	2.38	60	0.21	5	36	1.39	35
1C643-20-12	20	M30x2	3/4	2.46	62	0.21	5	40	1.03	37
1C643-25-12	25	M36x2	3/4	2.48	63	0.28	7	46	1.56	40
1C643-30-16	30	M42x2	1	2.89	73	0.37	9	50	1.95	50

Metric L: Mates with EO "L" Series Fittings.
Metric S: Mates with EO "S" Series Fittings.

Accessories
D

Technical
E

1C043

Female Metric - Swivel - (Ball Nose)

# Part Number	Thread		Hose I.D. inch	A		C		mm	B	
	mm	M		inch	mm	inch	mm		inch	mm
1C043-20-12	20	M30x1,5	3/4	2.48	63	0.21	5	36	0.94	24
1C043-25-16	25	M38x1,5	1	2.99	76	0.28	7	46	1.14	29

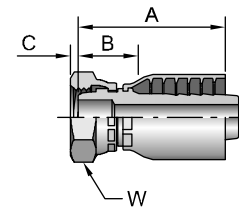

1C 43

Female Metric S - Swivel - (24 Cone with -Ring)
ISO 12151-2 - SWS

# Part Number	Thread		Hose I.D. inch	A		C		mm	B	
	mm	M		inch	mm	inch	mm		inch	mm
1C943-6-4	6	M14x1,5	1/4	1.89	48	0.01	0	17	1.02	26
1C943-8-4	8	M16x1,5	1/4	1.64	42	0.01	0	19	1.18	30
1C943-10-4	10	M18x1,5	1/4	1.64	42	0.01	0	22	1.18	30
1C943-10-5	10	M18x1,5	5/16	1.81	46	0.01	0	22	0.87	22
1C943-10-6	10	M18x1,5	3/8	1.97	50	0.01	0	22	0.83	21
1C943-12-5	12	M20x1,5	5/16	1.80	46	0.03	1	24	0.99	25
1C943-12-5	12	M20x1,5	5/16	1.89	48	0.03	1	24	0.94	24
1C943-12-6	12	M20x1,5	3/8	1.99	51	0.03	1	24	1.04	26
1C943-14-6	14	M22x1,5	3/8	2.05	52	0.03	1	27	1.17	30
1C943-16-8	16	M24x1,5	1/2	2.33	59	0.09	2	30	1.15	29
1C943-20-10	20	M30x2	5/8	2.59	66	0.05	1	36	1.22	31
1C943-20-12	20	M30x2	3/4	2.59	66	0.05	1	36	1.22	31
1C943-25-12	25	M36x2	3/4	2.67	68	0.10	3	46	1.24	31
1C943-25-16	25	M36x2	1	3.05	77	0.08	2	46	1.43	36
1C943-30-16	30	M42x2	1	3.19	81	0.19	5	50	1.60	41
1C943-38-20	38	M52x2	1-1/4	3.35	85	0.23	6	60	1.70	43

Must be assembled with Die Part No. 83C-A20H in a Superkrimp or Parkrimp 2.

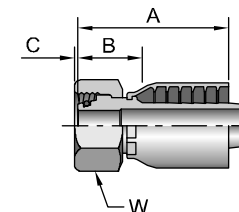

10C43

Female Metric S - Swivel - 45 Elbow - (24 Cone with -Ring)
ISO 12151-2 - SWE45

# Part Number	Thread		Hose I.D. inch	A		E		mm	B	
	mm	M		inch	mm	inch	mm		inch	mm
10C43-8-4	8	M16x1,5	1/4	2.32	59	0.63	16	19	1.38	35
10C43-12-5	12	M20x1,5	5/16	2.80	71	0.67	17	24	1.85	47
10C43-12-6	12	M20x1,5	3/8	3.28	83	0.87	22	24	2.28	58
10C43-16-8	16	M24x1,5	1/2	3.96	101	0.96	24	30	2.71	69
10C43-20-10	20	M30x2	5/8	4.78	121	1.12	28	36	3.37	86
10C43-20-12	20	M30x2	3/4	3.94	100	1.14	29	36	2.36	60
10C43-25-12	25	M36x2	3/4	3.97	101	1.06	27	46	2.40	61
10C43-30-16	30	M42x2	1	4.65	118	1.22	31	50	2.87	73
10C43-38-20	38	M52x2	1-1/4	4.96	126	1.30	33	60	1.89	48

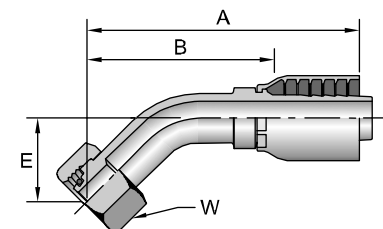

Hose
A

Fittings
43 Series
B

Equipment
C

Accessories
D

Technical
E

11C43

Female Metric S - Swivel - 0 Elbow - (24 Cone with -Ring)
ISO 12151-2 - SWE

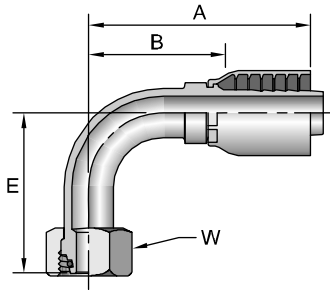

# Part Number	Thread mm	Hose I.D. inch	A		E		mm	B	
			inch	mm	inch	mm		inch	mm
11C43-8-4	8 M16x1,5	1/4	1.83	46	1.26	32	19	1.41	36
11C43-10-4	10 M18x1,5	1/4	2.45	62	1.34	34	22	1.71	43
11C43-12-5	12 M20x1,5	5/16	2.30	58	1.22	31	24	1.51	38
11C43-12-6	12 M20x1,5	3/8	2.36	60	1.22	31	24	1.42	36
11C43-14-6	14 M22x1,5	3/8	2.35	60	1.48	38	27	1.35	34
11C43-16-8	16 M24x1,5	1/2	2.94	75	1.75	44	30	1.69	43
11C43-20-10	20 M30x2	5/8	3.45	88	2.17	55	36	2.04	52
11C43-25-12	25 M36x2	3/4	3.74	95	2.17	55	46	2.22	56
11C43-30-16	30 M42x2	1	4.45	113	2.64	67	50	2.64	67
11C43-38-20	38 M52x2	1-1/4	5.67	144	2.87	73	60	2.99	76

1D 43

Male BSP Parallel Pipe - Rigid - (60° Cone)
ISO 228-1

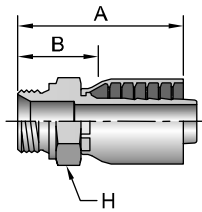

# Part Number	Thread inch	Hose I.D. inch	A		H mm	B	
			inch	mm		inch	mm
1D943-4-4	1/4x19	1/4	1.77	45	19	0.91	23
1D943-6-5	3/8x19	5/16	2.13	54	22	1.22	31
1D943-6-6	3/8x19	3/8	2.13	54	22	1.22	31
1D943-8-6	1/2x14	3/8	2.36	60	27	1.22	31
1D943-8-8	1/2x14	1/2	2.44	62	27	1.10	28
1D943-12-12	3/4x14	3/4	2.76	70	32	1.18	30
1D943-16-16	1x11	1	3.23	82	41	1.38	35

When used in a port, a bonded seal must be used. See Accessories Section for more information.

1 243

Female BSP Parallel Pipe - Swivel - (60° Cone)
ISO 228-1

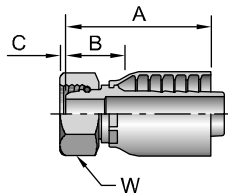

# Part Number	Thread inch	Hose I.D. inch	A		C		mm	B	
			inch	mm	inch	mm		inch	mm
19243-2-4	1/8x28	1/4	1.61	41	0.20	5	14	0.67	17
19243-4-4	1/4x19	1/4	1.95	50	0.22	6	19	1.20	30
19243-6-4	3/8x19	1/4	1.73	44	0.26	7	22	0.79	20
19243-6-6	3/8x19	3/8	2.35	60	0.26	7	22	1.32	34
19243-6-8	3/8x19	1/2	2.17	55	0.26	7	22	0.79	20
19243-8-6	1/2x14	3/8	2.01	51	0.28	7	27	0.87	22
19243-8-8	1/2x14	1/2	2.72	69	0.28	7	27	1.46	37
19243-10-8	5/8x14	1/2	2.80	71	0.37	9	30	1.54	39
19243-10-10	5/8x14	5/8	2.99	76	0.37	9	30	1.55	39
19243-12-10	3/4x14	5/8	3.11	79	0.35	9	36	1.67	42
19243-12-12	3/4x14	3/4	3.19	81	0.35	9	36	1.75	44
19243-16-16	1x11	1	3.67	93	0.44	11	41	2.05	52
19243-20-20	1-1/4x3	1-1/4	3.11	79	0.41	11	50	1.26	32

When measuring overall length to the end of the nut, B C dimensions must be used to calculate cut-off allowance.

1B143

Female BSP Parallel Pipe - Swivel - 45° Elbow - (60° Cone)
ISO 228-1

# Part Number	Thread inch	Hose I.D. inch	A		E		mm	B	
			inch	mm	inch	mm		inch	mm
1B143-4-4	1/4x19	1/4	2.44	62	0.63	16	19	1.54	39
1B143-6-6	3/8x19	3/8	3.25	83	0.79	20	22	2.25	57
1B143-8-8	1/2x14	1/2	3.35	85	0.79	20	27	1.97	50
1B143-10-10	5/8x14	5/8	4.03	102	0.85	22	30	2.62	67
1B143-12-10	3/4x14	5/8	4.09	104	1.14	29	32	2.52	64
1B143-12-12	3/4x14	3/4	4.02	102	1.14	29	32	2.44	62
1B143-16-16	1x11	1	4.53	115	1.14	29	41	2.76	70

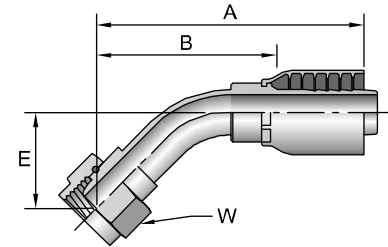

1B243

Female BSP Parallel Pipe - Swivel - 0° Elbow - (60° Cone)
ISO 228-1

# Part Number	Thread inch	Hose I.D. inch	A		E		mm	B	
			inch	mm	inch	mm		inch	mm
1B243-2-4	1/8x28	1/4	1.97	50	1.10	28	14	1.02	26
1B243-4-4	1/4x19	1/4	1.83	46	1.12	28	19	1.08	27
1B243-6-6	3/8x19	3/8	2.32	59	1.46	37	22	1.32	34
1B243-8-6	1/2x14	3/8	2.60	66	1.38	35	27	1.46	37
1B243-8-8	1/2x14	1/2	2.95	75	1.57	40	27	1.57	40
1B243-10-8	5/8x14	1/2	2.91	74	1.57	40	30	1.54	39
1B243-10-10	5/8x14	5/8	3.13	80	1.57	40	30	1.72	44
1B243-12-10	3/4x14	5/8	3.62	92	2.32	59	32	2.05	52
1B243-12-12	3/4x14	3/4	3.58	91	2.32	59	32	2.00	51
1B243-16-16	1x11	1	4.33	110	2.48	63	41	2.56	65
1B243-20-20	1-1/4x11	1-1/4	4.72	120	2.99	76	50	2.87	73

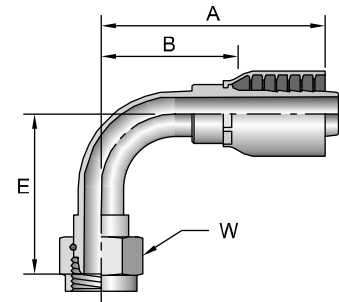

1B443

Female BSP Parallel Pipe - Swivel - 0°
Elbow - Block Type - (60° Cone)
ISO 228-1

# Part Number	Thread inch	Hose I.D. inch	A		E		H		B	
			inch	mm	inch	mm	mm	mm	inch	mm
1B443-4-4	1/4x19	1/4	2.40	61	1.14	29	17	19	1.40	36
1B443-6-6	3/8x19	3/8	2.76	70	1.02	26	19	22	1.42	36
1B443-8-8	1/2x14	1/2	3.19	81	1.02	26	22	27	1.57	40
1B443-12-12	3/4x14	3/4	3.30	84	1.30	33	23	32	0.98	25

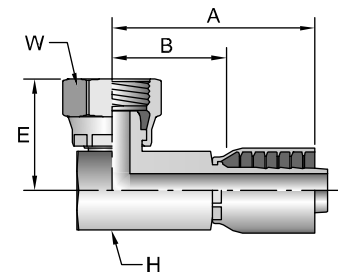

Metric S: Mates with EO "S" Series Fittings.

When measuring overall length to the end of the nut, B C dimensions must be used to calculate cut-off allowance.

Hose
A
 Fittings
 43 Series
B
 Equipment
C
 Accessories
D
 Technical
E

1B543

Female BSP Parallel Pipe - Swivel - (Flat Seat)
ISO 228-1

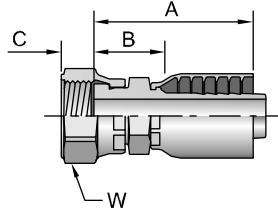

#	Thread	Hose I.D.	A		C			B	
Part Number	inch	inch	inch	mm	inch	mm	mm	inch	mm
1B543-6-6	3/8x19	3/8	1.93	49	0.35	9	22	0.79	20
1B543-8-6	1/2x14	3/8	1.89	48	0.43	11	27	0.75	19
1B543-8-8	1/2x14	1/2	2.28	58	0.43	11	27	0.94	24
1B543-12-12	3/4x14	3/4	2.28	58	0.33	8	32	0.94	24

When measuring overall length to the end of the nut, B C dimensions must be used to calculate cut-off allowance.

14 43

DIN Metric Ban o

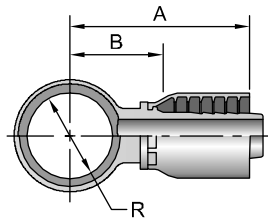

#	R	Hose I.D.	A		B	
Part Number	mm	inch	inch	mm	inch	mm
14943-10-4	10		1.85	47	0.94	24
14943-12-4	12	1/4	1.85	47	0.98	25
14943-14-5	14	5/16	2.01	51	1.06	27
14943-16-6	16	3/8	2.28	58	1.14	29
14943-18-8	18	1/2	2.60	66	1.22	31
14943-22-10	22	5/8	2.91	74	1.38	35
14943-26-12	26	3/4	3.07	78	1.54	39

AM Ban o Bolt w DIN Metric Thread

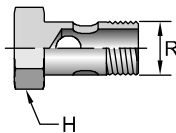

#	R	Thread	H	Copper washer 2
Part Number	mm	mm	mm	
AM-03	8	M8x1	12	853009-8
AM-04	10	M10x1	14	853009-10
AM-06	12	M12x1,5	17	853009-12
AM-08	14	M14x1,5	19	853009-14
AM-10	16	M16x1,5	22	853009-16
AM-13	18	M18x1,5	24	853009-18
AM-16	22	M22x1,5	27	853009-22
AM-20	26	M26x1,5	32	853009-26
AM-30	30	M30x1,5	36	853009-30

Two (2) copper washers per bolt must be ordered separately.

Metric S: Mates with EO "S" Series Fittings.
Must be assembled with Die Part No. 83C-A20H in a Superkrimp or Parkrimp 2.



1M 43
Female Metric - Swivel - (30° Flare)

# Part Number	Thread mm	Hose I.D. inch	A		H		B	
			inch	mm	mm	mm	inch	mm
1MU43-4-4	M14x1,5	1/4	2.07	53	19	19	1.32	34
1MU43-6-4	M18x1,5	1/4	2.18	55	24	24	1.43	36
1MU43-6-6	M18x1,5	3/8	2.45	62	24	24	1.42	36
1MU43-8-8	M22x1,5	1/2	2.84	72	27	27	1.58	40

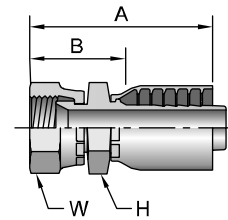

Japanese Fittings - Female Swivel 30° Flare with Metric Threads. All 30° flared fitting sizes are available by combining the 1MU43 fittings in sizes up to -8 with the 1XU43 fittings in sizes -10 and larger.

1 43
Female Metric - Swivel - (30° Flare)

# Part Number	Thread mm	Hose I.D. inch	A		H		B	
			inch	mm	mm	mm	inch	mm
1XU43-10-10	M24x1,5	5/8	3.25	83	30	32	1.81	46
1XU43-12-12	M30x1,5	3/4	3.40	86	32	36	1.96	50
1XU43-16-16	M33x1,5	1	4.03	102	36	41	2.41	61
1XU43-20-20	M36x1,5	1-1/4	4.19	106	46	46	2.50	64
1XU43-24-24	M42x1,5	1-1/2	4.12	105	50	55	2.75	70

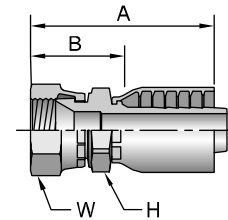

Japanese Fittings - Female Swivel 30° Flare with Metric Threads. All 30° flared fitting sizes are available by combining the 1MU43 fittings in sizes up to -8 with the 1XU43 fittings in sizes -10 and larger.

Hose
A

Fittings
43 Series
B

Equipment
C

Accessories
D

Technical
E

Hose
A

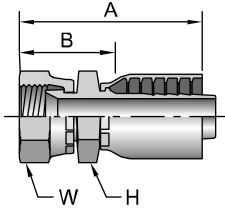

1F 43

Female BSP Parallel Pipe - Swivel - (30° Flare)
ISO 228-1

# Part Number	Thread inch	Hose I.D. inch	A		H		B	
			inch	mm	mm	mm	inch	mm
1FU43-4-4	1/4x19	1/4	1.90	48	19	19	1.15	29
1FU43-6-6	3/8x19	3/8	2.32	59	22	22	1.29	33
1FU43-8-8	1/2x14	1/2	2.66	68	27	27	1.40	36
1FU43-12-12	3/4x14	3/4	3.06	78	36	36	1.62	41
1FU43-16-16	1x11	1	3.53	90	41	41	1.91	49
1FU43-20-20	1-1/4x11	1-1/4	3.87	98	50	50	2.18	55

Fittings
43 Series
B

1 T43

Male BSP Taper Pipe - Rigid - (60° Cone)

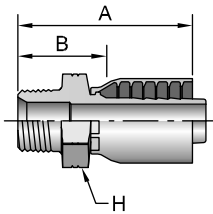

# Part Number	Thread inch	Hose I.D. inch	A		H	B	
			inch	mm	mm	inch	mm
1UT43-4-4	1/4x19	1/4	1.92	49	19	1.17	30
1UT43-6-6	3/8x19	3/8	2.25	57	22	1.22	31
1UT43-8-8	1/2x14	1/2	2.68	68	27	1.42	36
1UT43-12-12	3/4x14	3/4	2.96	75	36	1.53	39
1UT43-16-16	1x11	1	3.48	88	41	1.86	47
1UT43-20-20	1-1/4x11	1-1/4	3.75	95	50	2.10	53

Equipment
C

1 43

Female BSP Parallel Pipe - Swivel - (60° Cone)
ISO 228-1

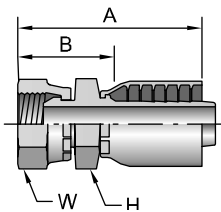

# Part Number	Thread inch	Hose I.D. inch	A		H		B	
			inch	mm	mm	mm	inch	mm
1 U43-4-4	1/4x19	1/4	2.08	53	19	19	1.33	34
1 U43-6-6	3/8x19	3/8	2.45	62	22	22	1.42	36
1 U43-8-8	1/2x14	1/2	2.81	71	27	27	1.56	40
1 U43-12-12	3/4x14	3/4	3.24	82	36	36	1.81	46
1 U43-16-16	1x11	1	3.74	95	41	41	2.12	54
1 U43-20-20	1-1/4x11	1-1/4	4.07	103	50	50	2.38	60

Accessories
D

Technical
E





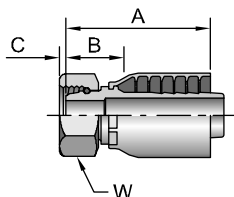





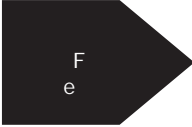
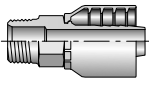

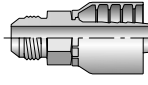
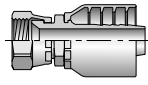
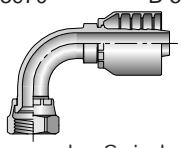
1F443

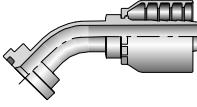
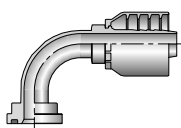
Female French 43 Series - Swivel - (Ball Nose)

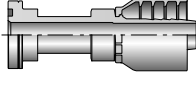
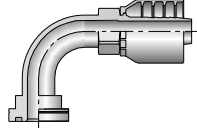
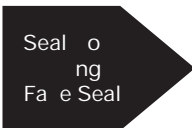
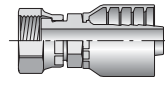
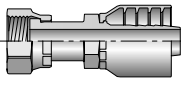
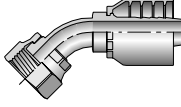
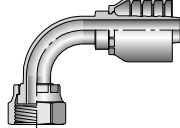
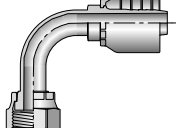
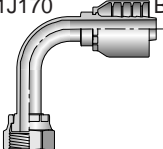

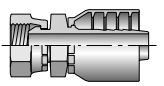
# Part Number	Thread mm	Hose I.D. inch	A		C		B		
			inch	mm	inch	mm	inch	mm	
1F443-27-12	27 M36x1,5	3/4	3	76	0.14	4	55	1.14	29

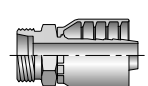
When measuring overall length to the end of the nut, B C dimensions must be used to calculate cut-off allowance.

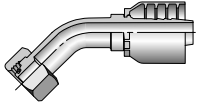
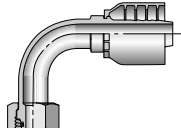
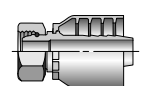
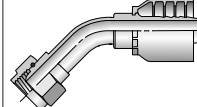
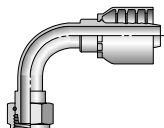
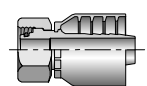
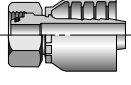
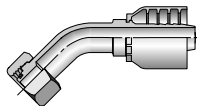
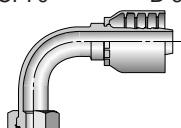
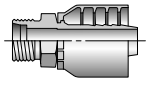
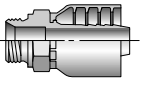
	10170 B-58  Male Rigid		10370 B-58  Male Rigid	10670 B-58  Female Swivel	13970 B-58  Female Swivel Elbow Short
	11770 B-59  Elbow	11970 B-59  Elbow		16A70 B-59  Flange Head	16N70 B-60  Elbow
	1JC70 B-60  Female Swivel Short	1JS70 B-60  Female Swivel Long	1J770 B-60  Female Swivel Elbow	1J970 B-61  Female Swivel Elbow Short	1J570 B-61  Female Swivel Elbow Medium
1J170 B-61  Female Swivel Elbow Long		1JU70 B-62  Female Swivel		1F70 B-62  Male Rigid	
10C70 B-63  Female Metric Swivel Elbow	11C70 B-63  Female Metric Swivel Elbow	19270 B-63  Female SP Cone	1B170 B-63  Female SP Elbow	1B270 B-64  Female SP Elbow	1C970 B-64  Female Swivel
1CA70 B-64  Female Metric Swivel 2 Cone	1CE70 B-64  Female Metric Swivel Elbow	1CF70 B-65  Female Metric Swivel Elbow	1D270 B-65  Male Metric Swivel Rigid	1D970 B-65  Male SP Rigid	

Hose
A
Fittings 70 Series
B
Equipment
C
Accessories
D
Technical
E



Hose
A

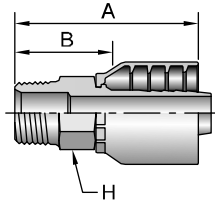

10170
Male NPTF Pipe - Rigid

# Part Number	Thread		Hose I.D.		A		H		B	
	inch	inch	inch	mm	inch	mm	inch	mm	inch	mm
10170-6-6	3/8x18		3/8		2.37	60	3/4		1.47	37
10170-8-8	1/2x14		1/2		2.84	72	7/8		1.40	36

Fittings
70 Series
B

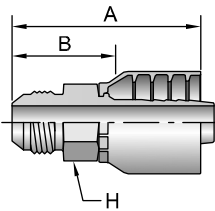

10370
Male JIC 37 - Rigid

# Part Number	Thread		Hose I.D.		A		H		B	
	inch	inch	inch	mm	inch	mm	inch	mm	inch	mm
10370-8-8	1/2	3/4x16	1/2		2.68	68	7/8		1.47	37
10370-10-8	5/8	7/8x14	1/2		2.62	66	15/16		1.41	36

Equipment
C

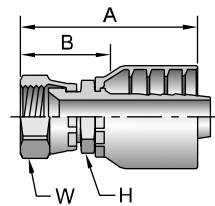

10670
Female JIC 37° - Swivel

# Part Number	Thread		Hose I.D.		A		H		B	
	inch	inch	inch	mm	inch	mm	inch	mm	inch	mm
10670-6-6	3/8	9/16x18	3/8		2.29	58	11/16	11/16	1.39	35
10670-8-8	1/2	3/4x16	1/2		2.62	67	13/16	7/8	1.41	36
10670-10-8	5/8	7/8x14	1/2		2.85	72	7/8	1	1.64	42
10670-10-10	5/8	7/8x14	5/8		2.84	72	15/16	1	1.59	40

Accessories
D

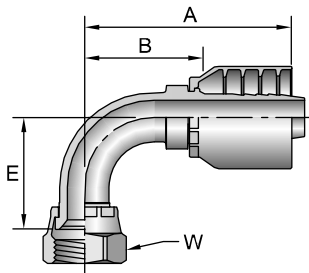



13 70
Female JIC 37° - Swivel - 90° Elbow - Short Drop

# Part Number	Thread		Hose I.D.		A		E		B		
	inch	inch	inch	mm	inch	mm	inch	mm	inch	mm	
13970-8-8	1/2	3/4x16	1/2		2.62	67	1.14	29	7/8	1.41	36

Technical
E

11770

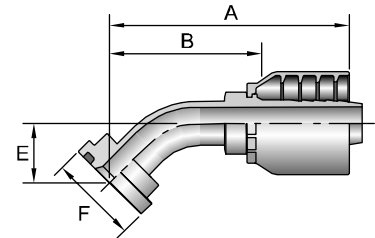

SAE Code 61 Flange Head - 45 Elbow
ISO 12151-3 - 45S - L

#			A		E			B	
			inch	mm	inch	mm		inch	mm
11770-8-8	1/2	1/2	3.28	83	0.77	20	1-3/16	2.07	53
11770-12-10	3/4	5/8	3.37	86	0.76	19	1-1/2	2.12	54



11 70

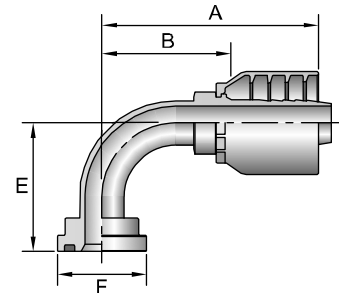

SAE Code 61 Flange Head - 0 Elbow
ISO 12151-3 - E90S - L

#			A		E			B	
			inch	mm	inch	mm		inch	mm
11970-8-8	1/2	1/2	2.93	74	1.60	41	1-3/16	1.72	44
11970-12-10	3/4	5/8	3.54	90	2.02	51	1-1/2	2.29	58



16A70

SAE Code 62 Flange Head
ISO 12151-3 - S - S

#			A			B	
			inch	mm		inch	mm
16A70-8-8	1/2	1/2	3.50	88,9	1-1/4	2.29	56,9

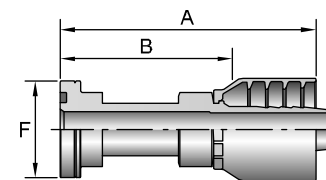

See Accessories for Flange fits and O-Rings.



Hose
A
Fittings
70 Series
B
Equipment
C
Accessories
D
Technical
E

Hose
A

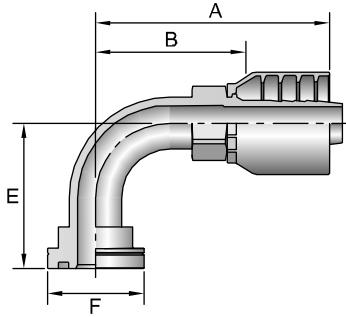

16N70

SAE Code 62 Flange Head - 0 Elbow

ISO 12151-3 - E90S - S (1 Piece: ISO 12151-3 - E90M - S)

#			A		E			B	
Part Number	Flange inch	Hose I.D. inch	inch	mm	inch	mm	inch	inch	mm
16N70-8-8	1/2	1/2	2.60	66	1.61	41	1-1/4	1.34	34

Fittings
70 Series
B

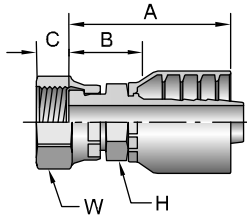

1JC70

Female Seal-Lok - Swivel - Short

ISO 12151-1 - SWSA

#			A		C				B	
Part Number	Thread inch	Hose I.D. inch	inch	mm	inch	mm	inch	inch	inch	mm
1JC70-6-6	3/8 11/16x16	3/8	1.94	49	0.34	9	11/16	13/16	1.04	26
1JC70-8-6	1/2 13/16x16	3/8	2.00	51	0.43	11	13/16	15/16	1.10	28
1JC70-8-8	1/2 13/16x16	1/2	2.22	56	0.43	11	13/16	15/16	1.01	26
1JC70-10-10	5/8 1x14	5/8	2.40	61	0.53	13	15/16	1-1/8	1.15	29

Equipment
C

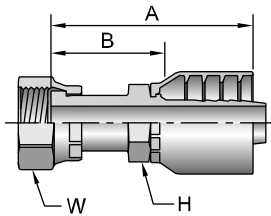

1JS70

Female Seal-Lok - Swivel - Long

ISO 12151-1 - SWSB

#			A				B	
Part Number	Thread inch	Hose I.D. inch	inch	mm	inch	inch	inch	mm
1JS70-6-6	3/8 11/16x16	3/8	2.28	58	11/16	13/16	1.38	35
1JS70-8-8	1/2 13/16x16	1/2	2.65	67	13/16	15/16	1.44	37
1JS70-12-8	3/4 1-3/16x12	1/2	2.90	74	1-1/8	1-3/8	1.69	43
1JS70-12-10	3/4 1-3/16x12	5/8	3.10	79	1-1/8	1-3/8	1.85	47

Accessories
D

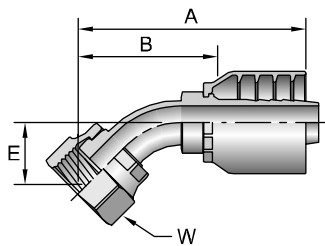

1J770

Female Seal-Lok - Swivel - 45° Elbow

ISO 12151-1 - SWE45

#			A		E			B	
Part Number	Thread inch	Hose I.D. inch	inch	mm	inch	mm	inch	inch	mm
1J770-10-10	5/8 1x14	5/8	3.08	78	0.63	16	1-1/8	1.83	46

Technical
E

See Accessories for Flange fits and O-Rings.



1J 70

Female Seal-Lok - Swivel - 0 Elbow - Short Drop
ISO 12151-1 - SWES90

# Part Number	Thread		Hose I.D. inch	A		E		B		
	inch	mm		inch	mm	inch	mm	inch	mm	
1J970-8-8	1/2	13/16x16	1/2	2.59	66	1.14	29	15/16	1.38	35
1J970-12-8	3/4	1-3/16x12	1/2	3.21	82	1.88	48	1-3/8	2.00	51

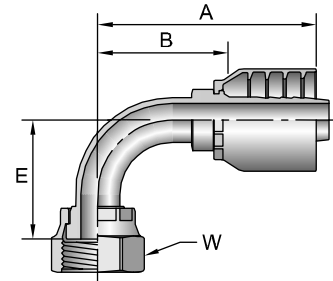

1J570

Female Seal-Lok - Swivel - 0 Elbow - Medium Drop
ISO 12151-1 - SWSB

# Part Number	Thread		Hose I.D. inch	A		E		B		
	inch	mm		inch	mm	inch	mm	inch	mm	
1J570-10-10	5/8	1x14	5/8	2.88	73	1.85	47	1-1/8	1.63	41

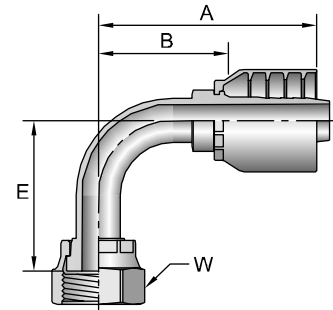

1J170

Female Seal-Lok - Swivel - 0 Elbow - Long Drop
ISO 12151-1 - SWEL90

# Part Number	Thread		Hose I.D. inch	A		E		B		
	inch	mm		inch	mm	inch	mm	inch	mm	
1J170-8-8	1/2	13/16x16	1/2	2.59	66	2.52	65	15/16	1.38	35
1J170-10-10	5/8	1x14	5/8	2.88	73	2.76	70	1-1/8	1.63	41

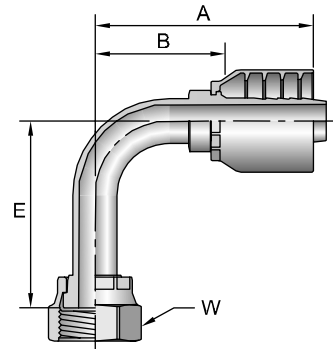

Hose
A

Fittings
70 Series
B

Equipment
C

Accessories
D

Technical
E

See Accessories for Flange fits and O-Rings.



Hose
A

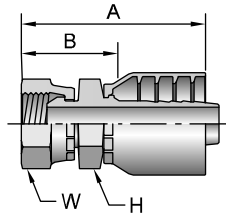

1 70
Female BSP Parallel Pipe - Swivel - (60 Cone)

#	Thread	Hose I.D.	A		H		B	
Part Number	Inch	inch	inch	mm	mm	inch	inch	mm
1 U70-6-6	3/8x19	3/8	2.45	62	22	NA	1.55	39
1 U70-8-8	1/2x14	1/2	2.82	72	27	NA	1.61	41

Fittings
70 Series
B

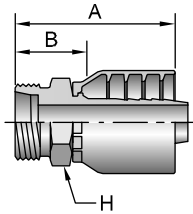

1F 70
Male French haz Series - Rigid - (24 Cone)

#	Thread	Hose I.D.	A		H		B	
Part Number	mm	inch	inch	mm	inch	mm	inch	mm
1F 70-21-10	M30x1,5	5/8	2.87	73	1.18	30	1.62	41

Equipment
C

Accessories
D

Technical
E



10C70

Female Metric S - Swivel - 45° Elbow - (24° Cone with -Ring)
ISO 12151-2 - SWE45

# Part Number	Thread mm	Hose I.D. inch	A		E		B		
			inch	mm	inch	mm	mm	inch	mm
10C70-12-6	12 M20x1,5	3/8	2.72	69	0.79	20	24	1.57	40
10C70-16-8	16 M24x1,5	1/2	3.27	83	0.94	24	30	1.89	48
10C70-20-10	20 M30x2	5/8	3.58	91	0.98	25	36	2.05	52

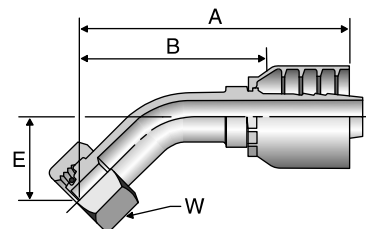

11C70

Female Metric S - Swivel - 90° Elbow - (24° Cone with -Ring)
ISO 12151-2 - SWE

# Part Number	Thread mm	Hose I.D. inch	A		E		B		
			inch	mm	inch	mm	mm	inch	mm
11C70-12-6	12 M20X1,5	3/8	2.64	67	1.46	37	24	1.50	38
11C70-20-10	20 M30X2	5/8	3.11	79	1.89	48	36	1.57	40

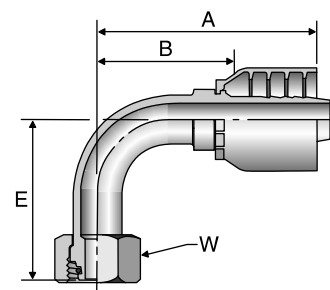

1 270

Female BSP Parallel Pipe - Swivel - (60° Cone)
ISO 228-1

# Part Number	Thread inch	Hose I.D. inch	A		C		B		
			inch	mm	inch	mm	mm	inch	mm
19270-6-6	3/8x19	3/8	1.93	49	0.28	7	22	0.79	20
19270-8-8	1/2x14	1/2	2.24	57	0.28	7	27	0.87	22
19270-10-10	5/8x14	5/8	2.24	57	0.35	9	30	0.83	21
19270-12-10	3/4x14	5/8	2.40	61	0.35	9	32	0.87	22

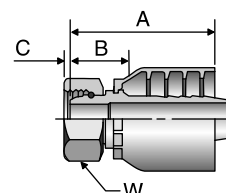

1B170

Female BSP Parallel pipe - Swivel- 45° Elbow - (60° Cone)
ISO 228-1

# Part Number	Thread inch	Hose I.D. inch	A		E		B		
			inch	mm	inch	mm	mm	inch	mm
1B170-8-8	1/2x14	1/2	3.11	79	0.79	20	27	1.77	45

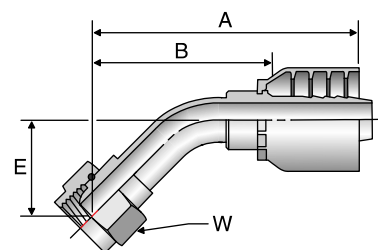

Hose

A

Fittings
70 Series

B

Equipment

C

Accessories

D

Technical

E

Hose
A

Fittings
70 Series
B

Equipment
C

Accessories
D

Technical
E

1B270

Female BSP Parallel Pipe - Swivel - 90° Elbow - (60° Cone)
ISO 228-1

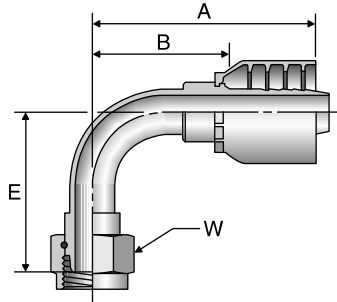

# Part Number	Thread inch	Hose I.D. inch	A		E		B		
			inch	mm	inch	mm	mm	inch	mm
1B270-8-8	1/2x14	1/2	2.76	70	1.54	39	27	1.38	35
1B270-10-10	5/8x14	5/8	3.07	78	1.81	46	30	1.61	41
1B270-12-10	3/4x14	5/8	3.19	81	1.65	42	32	1.61	41

1C 70

Female Metric S - Swivel - (24° Cone with O-Ring)

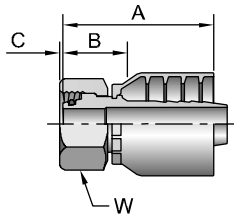

# Part Number	Thread mm		Hose I.D. inch	A		C		mm	B	
				inch	mm	inch	mm		inch	mm
1C970-12-6	12	M20x1,5	3/8	2.03	52	0.03	1	24	1.13	29
1C970-16-8	16	M24x1,5	1/2	2.31	59	0.09	2	30	1.10	28
1C970-20-10	20	M30x2	5/8	2.51	64	0.05	1	36	1.26	32

When measuring overall length to end of nut, B C dimensions must be used to calculate cut-off allowance.

1CA70

Female Metric L - Swivel - (24° Cone with O-Ring)
ISO 12151-2 - SWS

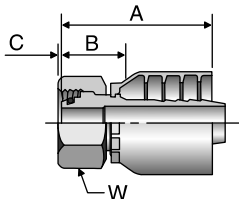

# Part Number	Thread mm		Hose I.D. inch	A		C		mm	B	
				inch	mm	inch	mm		inch	mm
1CA70-12-6	12	M18x1,5	3/8	2.09	53	0.04	1	22	0.94	24
1CA70-15-8	15	M22x1,5	1/2	2.09	62	0.07	2	22	0.94	27
1CA70-18-10	18	M26x1,5	5/8	2.44	62	0.02	0.5	32	1.02	26

1CE70

Female Metric L - Swivel - 45° Elbow - (24° Cone with O-Ring)
ISO 12151-2 - SWE45

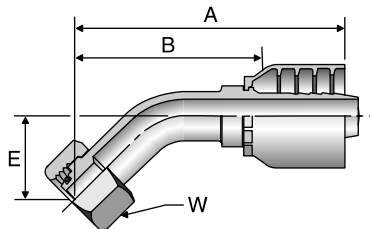

# Part Number	Thread mm		Hose I.D. inch	A		E		mm	B	
				inch	mm	inch	mm		inch	mm
1CE70-18-10	18	M26x1,5	5/8	3.58	91	0.98	25	32	2.05	52

1CF70

Female Metric L - Swivel - 0° Elbow - (24° Cone with -Ring)
ISO 12151-2 - SWE

# Part Number	Thread mm	Hose I.D. inch	A		E		mm	B	
			inch	mm	inch	mm		inch	mm
1CF70-15-8	15 M22x1,5	1/2	2.91	74	1.77	45	27	1.54	39
1CF70-18-10	18 M26x1,5	5/8	3.11	79	1.93	49	32	1.65	42

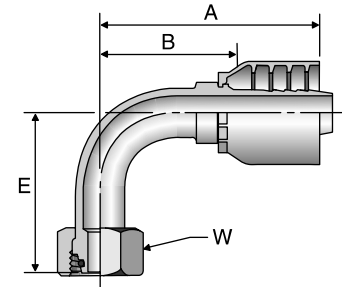

1D270

Male Metric S - Rigid - (24° Cone)
ISO 8434-1

# Part Number	Thread mm	Hose I.D. inch	A		H mm	B	
			inch	mm		inch	mm
1D270-16-8	16 M24x1,5	1/2	2.44	62	24	1.10	28
1D270-20-10	20 M30x2	5/8	2.95	75	30	1.26	32

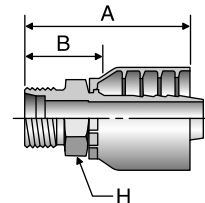

1D 70

Male BSP Parellel Pipe - Rigid - (60° Cone)
ISO 228-1

# Part Number	Thread inch	Hose I.D. inch	A		H mm	B	
			inch	mm		inch	mm
1D970-8-8	1/2x14	1/2	2.44	62	27	1.10	28

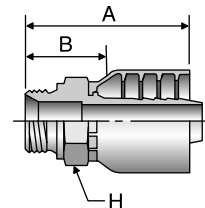

Hose
A

Fittings
70 Series
B

Equipment
C

Accessories
D

Technical
E

Hose

A

Fittings

B

Equipment

C











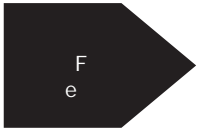
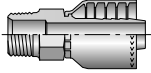

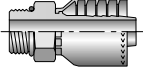

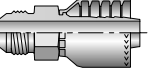
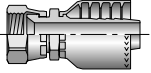
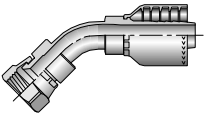
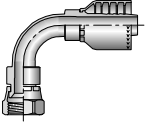
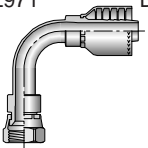
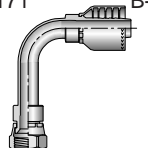

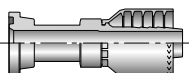
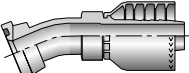
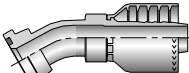
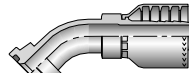
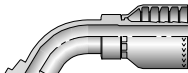
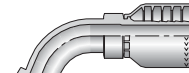
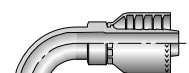
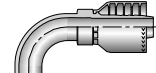
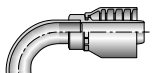
Accessories

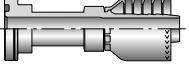
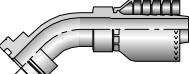
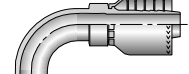
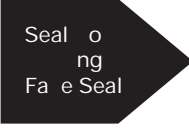
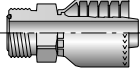
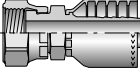
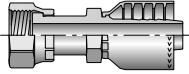
D

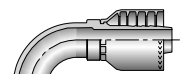
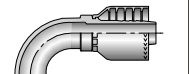
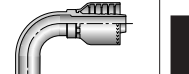
Technical

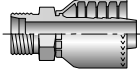
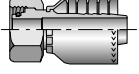
E

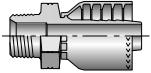
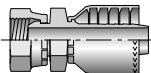
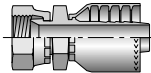

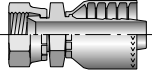
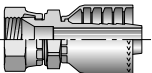
 F e	10171 B-68  Male Rigid	 S	10571 B-68  Male Rigid	 C	10371 B-68  Male Rigid
10671 B-69  Female Swivel	13771 B-69  Female Swivel elbow Short	13971 B-70  Female Swivel elbow Short	1L971 B-70  Female Swivel elbow Medium	14171 B-70  Female Swivel elbow Long	 Flange Coupling
11571 B-71  Flange	11671 B-71  22 1/2 lbow	12671 B-72  lbow	11771 B-72  lbow	12771 B-72  lbow	11871 B-73  7 1/2 lbow
11971 B-73  lbow	18971 B-74  lbow long	12U71 B-74  11 lbow	 Flange Coupling	16A71 B-74  Flange	16F71 B-74  lbow
16N71 B-75  lbow	 Sealing Female Seal	1J071 B-75  Male Rigid	1JC71 B-75  Female Swivel Short	1JS71 B-76  Female Swivel long	1J771 B-76  Female Swivel lbow
1J971 B-77  Female Swivel elbow Short	1J571 B-77  Female Swivel elbow Medium	1J171 B-77  Female Swivel elbow Long	 Mets	1D271 B-78  Male Rigid	1C971 B-78  Female Swivel
 S	1UT71 B-78  Male Rigid	1U71 B-78  Female Swivel	1FU71 B-79  Female Swivel	 Mets	1MU71 B-79  Female Swivel
1XU71 B-79  Female Swivel					

Hose
A

Fittings
71 Series
B

Equipment
C

Accessories
D

Technical
E

Hose
A

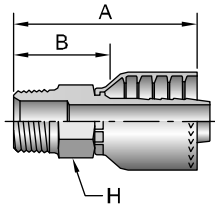

10171
Male NPTF Pipe - Rigid

# Part Number	Thread		Hose I.D.		A		B		
	inch		inch		inch	mm	inch	mm	
10171-6-6	3/8x18		3/8		2.36	60	3/4	1.47	37
10171-8-8	1/2x14		1/2		2.82	72	7/8	1.63	41
10171-12-8	3/4x14		1/2		2.67	68	1-1/16	1.47	37
10171-12-12	3/4x14		3/4		3.08	78	1-1/16	1.71	43
10171-16-12	1x11-1/2		3/4		3.08	78	1-3/8	1.72	44
10171-16-16	1x11-1/2		1		3.63	92	1-3/8	2.04	52
10171-20-16	1-1/4x11-1/2		1		3.49	89	1-11/16	1.90	48
10171-20-20	1-1/4x11-1/2		1-1/4		4.06	103	1-3/4	2.39	61
10171-24-20	1-1/2x11-1/2		1-1/4		3.77	96	2	2.10	53
10171-24-24	1-1/2x11-1/2		1-1/2		4.32	110	2	2.19	56
10171-32-32	2x11-1/2		2		4.66	118	2-1/2	2.52	64

Fittings
71 Series
B

10571
Male SAE Straight Thread with -Ring - Rigid

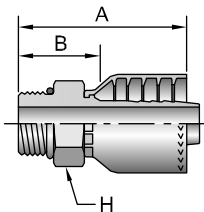

# Part Number	Thread		Hose I.D.		A		B		
	inch		inch		inch	mm	inch	mm	
10571-8-8	1/2	3/4x16	1/2		2.44	62	7/8	1.25	32
10571-12-12	3/4	1-1/16x12	3/4		2.79	71	1-1/4	1.43	36
10571-16-16	1	1-5/16x12	1		3.42	87	1-1/2	1.77	45
10571-20-20	1-1/4	1-5/8x12	1-1/4		3.67	93	1-7/8	2.00	51

Equipment
C

10371
Male JIC 37 - Rigid

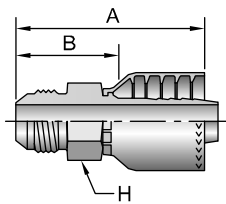

# Part Number	Thread		Hose I.D.		A		B		
	inch		inch		inch	mm	inch	mm	
10371-6-6	3/8	9/16x18	3/8		2.44	62	3/4	1.55	39
10371-8-6	1/2	3/4x16	3/8		2.29	58	7/8	1.40	36
10371-8-8	1/2	3/4x16	1/2		2.66	68	7/8	1.41	36
10371-10-8	5/8	7/8x14	1/2		2.60	66	15/16	1.41	36
10371-10-10	5/8	7/8x14	5/8		2.93	74	15/16	1.69	43
10371-12-12	3/4	1-1/16x12	3/4		3.17	80	1-1/8	1.81	46
10371-14-12	7/8	1-3/16x12	3/4		3.09	78	1-1/4	1.73	44
10371-16-12	1	1-5/16x12	3/4		3.02	77	1-3/8	1.66	42
10371-16-16	1	1-5/16x12	1		3.68	93	1-3/8	2.03	52
10371-20-16	1-1/4	1-5/8x12	1		3.43	87	1-7/8	1.84	47
10371-20-20	1-1/4	1-5/8x12	1-1/4		3.94	100	1-7/8	2.27	58

Accessories
D

Technical
E



10671

Female JIC 37 - Swivel

# Part Number	Thread		Hose I.D. inch	A		H		B		Additional Material Stainless Steel (C)
	inch	mm		inch	mm	inch	mm	inch	mm	
10671-6-6	3/8	9/16x18	3/8	2.28	58	11/16	11/16	1.39	35	
10671-8-6	1/2	3/4x16	3/8	2.47	63	11/16	7/8	1.58	40	
10671-8-8	1/2	3/4x16	1/2	2.61	66	13/16	7/8	1.41	36	
10671-10-8	5/8	7/8x14	1/2	2.84	72	7/8	1	1.64	42	
10671-10-10	5/8	7/8x14	5/8	2.83	72	15/16	1	1.58	40	
10671-10-12	5/8	7/8x14	3/4	2.92	74	1-1/16	1	1.54	39	
10671-12-8	3/4	1-1/16x12	1/2	2.75	70	1-1/16	1-1/4	1.58	40	
10671-12-10	3/4	1-1/16x12	5/8	3.00	76	1-1/16	1-1/4	1.75	44	
10671-12-12	3/4	1-1/16x12	3/4	2.96	75	1-1/16	1-1/4	1.60	41	
10671-12-16	3/4	1-1/16x12	1	3.37	86	1-3/8	1-1/4	1.67	42	
10671-14-12	7/8	1-3/16x12	3/4	3.01	76	1-1/4	1-3/8	1.61	41	
10671-16-12	1	1-5/16x12	3/4	3.28	83	1-1/4	1-1/2	1.92	49	
10671-16-16	1	1-5/16x12	1	3.60	91	1-3/8	1-1/2	2.01	51	
10671-20-16	1-1/4	1-5/8x12	1	3.80	97	1-5/8	2	2.21	56	
10671-20-20	1-1/4	1-5/8x12	1-1/4	3.92	100	1-7/8	2	2.25	57	
10671-24-20	1-1/2	1-7/8x12	1-1/4	4.10	104	2-1/8	2-1/4	2.43	62	
10671-24-24	1-1/2	1-7/8x12	1-1/2	4.69	119	2-1/8	2-1/4	2.50	64	
10671-32-32	2	2-1/2x12	2	5.39	137	2-1/2	2-7/8	3.19	81	

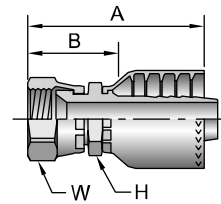

13771

Female JIC 37 - Swivel - 45 Elbow - Short Drop

# Part Number	Thread		Hose I.D. inch	A		E		B		
	inch	mm		inch	mm	inch	mm	inch	mm	
13771-6-6	3/8	9/16x18	3/8	2.34	59	0.43	11	11/16	1.44	37
13771-8-8	1/2	3/4x16	1/2	2.83	72	0.59	15	7/8	1.62	41
13771-10-8	5/8	7/8x14	1/2	2.93	74	0.63	16	1	1.72	44
13771-10-10	5/8	7/8x14	5/8	3.08	78	0.63	16	1	1.83	46
13771-12-12	3/4	1-1/16x12	3/4	3.64	92	0.83	21	1-1/4	2.26	57
13771-16-16	1	1-5/16x12	1	4.20	107	0.90	23	1-1/2	2.61	66
13771-20-20	1-1/4	1-5/8x12	1-1/4	5.22	133	1.69	43	2	3.53	90

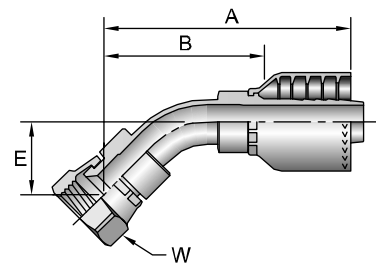

Stainless steel fittings must be assembled with arraykrimp 2, PHastkrimp, Superkrimp or Parkrimp 2. See CrimpSource for more information.

Must be assembled with Die Part No. 83C-D16H in a Superkrimp or Parkrimp 2.

Must be assembled with Die Part No. 83C-D20H in a Superkrimp or Parkrimp 2.



Hose
A

Fittings
71 Series
B

Equipment
C

Accessories
D

Technical
E

Hose
A

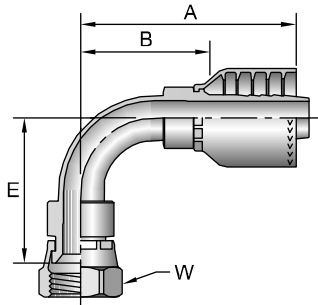

13 71

Female JIC 37 - Swivel - 0 Elbow - Short Drop

# Part Number	Thread inch		Hose I.D. inch	A		E		inch	B	
	inch	mm		inch	mm	inch	mm		inch	mm
13971-6-6	3/8	9/16x18	3/8	2.21	56	0.91	23	11/16	1.31	33
13971-8-8	1/2	3/4x16	1/2	2.62	67	1.14	29	7/8	1.41	36
13971-10-8	5/8	7/8x14	1/2	2.74	70	1.26	32	1	1.53	39
13971-10-10	5/8	7/8x14	5/8	2.88	73	1.26	32	1	1.63	41
13971-12-10	3/4	1-1/16x12	5/8	2.98	76	1.89	48	1-1/4	1.73	44
13971-12-12	3/4	1-1/16x12	3/4	3.50	89	1.89	48	1-1/4	2.11	54
13971-16-16	1	1-5/16x12	1	4.36	111	2.20	56	1-1/2	2.58	66
13971-20-20	1-1/4	1-5/8x12	1-1/4	4.78	121	3.33	85	2	3.11	79
13971-24-24	1-1/2	1-7/8x12	1-1/2	6.33	161	3.98	101	2-1/4	4.14	105

Fittings
71 Series
B

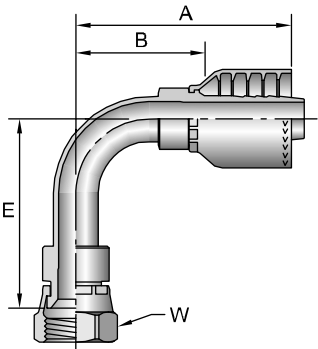

1L 71

Female JIC 37 - Swivel - 0 Elbow - Medium Drop

# Part Number	Thread inch		Hose I.D. inch	A		E		inch	B	
	inch	mm		inch	mm	inch	mm		inch	mm
1L971-10-8	5/8	7/8x14	1/2	3.24	82	1.75	44	1	2.04	52

Equipment
C

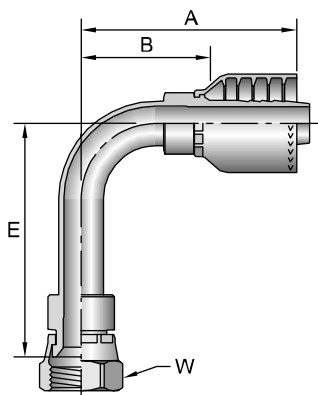

14171

Female JIC 37 - Swivel - 0 Elbow - Long Drop

# Part Number	Thread inch		Hose I.D. inch	A		E		inch	B	
	inch	mm		inch	mm	inch	mm		inch	mm
14171-6-6	3/8	9/16x18	3/8	2.34	59	2.13	54	11/16	1.44	37
14171-8-8	1/2	3/4x16	1/2	2.58	66	2.52	64	7/8	1.37	35
14171-12-12	3/4	1-1/16x14	3/4	3.49	89	3.78	96	1-1/4	2.11	54
14171-16-16	1	1-5/16x12	1	4.36	111	4.32	110	1-1/2	2.58	66

Accessories
D

Technical
E



11571

SAE Code 61 Flange Head
ISO 12151-3 - S - L

# Part Number	Flange inch	Hose I.D. inch	A		F inch	B	
			inch	mm		inch	mm
11571-8-8	1/2	1/2	3.48	88	1-3/16	2.27	58
11571-10-10	5/8	5/8	3.69	93,7	1-11/32	2.44	62,0
11571-12-8	3/4	1/2	2.46	62,5	1-1/2	1.26	32,0
11571-12-12	3/4	3/4	3.86	98	1-1/2	2.48	63
11571-16-12	1	3/4	2.74	70	1-3/4	1.36	35
11571-16-16	1	1	4.32	110	1-3/4	2.55	65
11571-20-12	1-1/4	3/4	3.90	99	2	2.54	65
11571-20-16	1-1/4	1	3.27	83	2	1.58	40
11571-20-20	1-1/4	1-1/4	4.70	119	2	3.01	76
11571-20-24	1-1/4	1-1/2	5.41	137	2	3.22	82
11571-24-16	1-1/2	1	3.41	86,6	2-3/8	1.63	41,4
11571-24-20	1-1/2	1-1/4	4.08	104	2-3/8	2.39	61
11571-24-24	1-1/2	1-1/2	5.46	139	2-3/8	3.27	83
11571-24-32	1-1/2	2	5.65	144	2-3/8	3.45	88
11571-32-20	2	1-1/4	4.29	109,0	2-13/16	2.60	66,0
11571-32-24	2	1-1/2	4.01	102	2-13/16	1.82	46
11571-32-32	2	2	5.65	144	2-13/16	3.45	88
11571-40-32	2-1/2	2	4.51	115	3-5/16	2.31	59

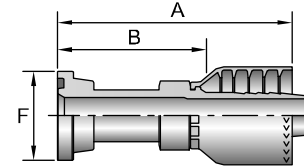

11671

SAE Code 61 Flange Head - 22-1 2 Elbow
ISO 12151-3 - E22M - L

# Part Number	Flange inch	Hose I.D. inch	A		E		F inch	B	
			inch	mm	inch	mm		inch	mm
11671-12-12	3/4	3/4	3.90	99	0.44	11	1-1/2	2.54	65
11671-16-12	1	3/4	3.89	99	0.44	11	1-3/4	2.53	64
11671-16-16	1	1	4.26	108	0.44	11	1-3/4	2.67	68
11671-20-16	1-1/4	1	4.36	111	0.47	12	2	2.77	70
11671-20-20	1-1/4	1-1/4	4.67	119	0.50	13	2	3.00	76
11671-24-20	1-1/2	1-1/4	4.68	119	0.53	13	2-3/8	3.01	76
11671-24-24	1-1/2	1-1/2	5.88	149	0.63	16	2-3/8	3.69	94
11671-32-32	2	2	7.37	187	0.88	22	2-13/16	5.22	133

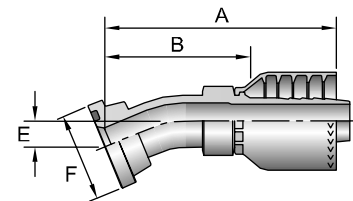

Must be assembled with Die Part No. 83C-D16H in a Superkrimp or Parkrimp 2.
Must be assembled with Die Part No. 83C-D20H in a Superkrimp or Parkrimp 2.
See Accessories for Flange its and O-Rings.

Hose
A

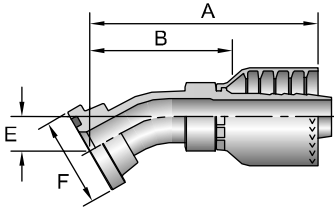

12671

SAE Code 61 Flange Head - 30 Elbow
ISO 12151-3 - E30S - L (1 Piece: ISO 12151-3 - E30M - L)

# Part Number	Flange inch	Hose I.D. inch	A		E		F inch	B	
			inch	mm	inch	mm		inch	mm
12671-12-12	3/4	3/4	3.90	99	0.59	15	1-1/2	2.52	64
12671-16-16	1	1	4.46	113	0.62	16	1-3/4	2.68	68
12671-20-16	1-1/4	1	4.46	113	0.62	16	2	2.68	68
12671-20-20	1-1/4	1-1/4	4.87	124	0.72	18	2	3.18	81
12671-24-24	1-1/2	1-1/2	6.01	153	0.88	22	2-3/8	3.82	97
12671-32-24	2	1-1/2	6.01	153	0.88	22	2-13/16	3.82	97
12671-32-32	2	2	7.60	193	1.25	32	2-13/16	5.40	137

Fittings
71 Series
B

11771

SAE Code 61 Flange Head - 45 Elbow
ISO 12151-3 - E45S - L (1 Piece: ISO 12151-3 - E45M - L)

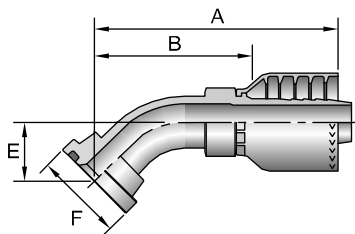

# Part Number	Flange inch	Hose I.D. inch	A		E		F inch	B	
			inch	mm	inch	mm		inch	mm
11771-10-10	5/8	5/8	4.54	115	0.94	24	1-11/32	3.29	84
11771-12-8	3/4	1/2	3.27	83	0.84	21	1-1/2	2.07	53
11771-12-10	3/4	5/8	3.94	100	0.76	19	1-1/2	2.70	69
11771-12-12	3/4	3/4	3.85	98	1.02	26	1-1/2	2.47	63
11771-16-12	1	3/4	3.85	98	1.02	26	1-3/4	2.47	63
11771-16-16	1	1	4.84	123	1.26	32	1-3/4	3.06	78
11771-20-16	1-1/4	1	4.84	123	1.02	26	2	3.06	78
11771-20-20	1-1/4	1-1/4	5.61	142	1.50	38	2	3.92	100
11771-20-24	1-1/4	1-1/2	6.22	158	1.12	28	2	4.03	102
11771-24-20	1-1/2	1-1/4	5.55	141	1.50	38	2-3/8	3.86	98
11771-24-24	1-1/2	1-1/2	6.22	158	1.41	36	2-3/8	4.03	102
11771-32-24	2	1-1/2	6.19	157	1.41	36	2-13/16	4.00	102
11771-32-32	2	2	7.94	202	2.03	52	2-13/16	5.74	146
11771-40-32	2-1/2	2	7.83	199	2.03	52	3-5/16	5.62	143

Equipment
C

12771

SAE Code 61 Flange Head - 60 Elbow
ISO 12151-3 - E60S - L (1 Piece: ISO 12151-3 - E60M - L)

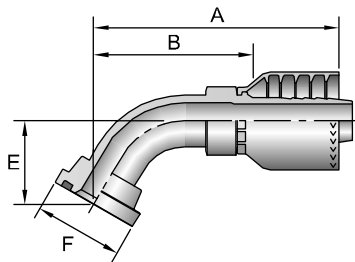

# Part Number	Flange inch	Hose I.D. inch	A		E		F inch	B	
			inch	mm	inch	mm		inch	mm
12771-12-12	3/4	3/4	4.16	106	1.43	36	1-1/2	2.78	71
12771-16-12	1	3/4	4.15	105	1.39	35	1-3/4	2.77	70
12771-16-16	1	1	4.74	120	1.49	38	1-3/4	3.36	85
12771-20-20	1-1/4	1-1/4	5.10	130	1.69	43	2	3.41	87
12771-24-20	1-1/2	1-1/4	5.12	130	1.70	43	2-3/8	3.43	87
12771-24-24	1-1/2	1-1/2	6.25	159	2.03	52	2-3/8	4.06	103
12771-32-32	2	2	7.93	201	2.88	73	2-13/16	5.73	146

D

Technical
E

Must be assembled with Die Part No. 83C-D16H in a Superkrimp or Parkrimp 2.
Must be assembled with Die Part No. 83C-D20H in a Superkrimp or Parkrimp 2.
See Accessories for Flange fits and O-Rings.

11871

SAE Code 61 Flange Head - 67-1 2 Elbow
ISO 12151-3 - E67S - L (1 Piece: ISO 12151-3 - E67M - L)

# Part Number	Flange inch	Hose I.D. inch	A		E		F inch	B	
			inch	mm	inch	mm		inch	mm
11871-12-12	3/4	3/4	4.12	105	1.62	41	1-1/2	2.74	70
11871-16-12	1	3/4	4.11	104	1.59	40	1-3/4	2.73	69
11871-16-16	1	1	4.76	121	1.75	44	1-3/4	2.98	76
11871-20-20	1-1/4	1-1/4	5.08	129	1.94	49	2	3.39	86
11871-24-20	1-1/2	1-1/4	5.07	129	1.95	50	2-3/8	3.38	86
11871-24-24	1-1/2	1-1/2	6.20	157	2.31	59	2-3/8	4.01	102
11871-32-24	2	1-1/2	6.20	157	2.31	59	2-13/16	4.01	102
11871-32-32	2	2	7.89	200	3.31	84	2-13/16	5.69	145

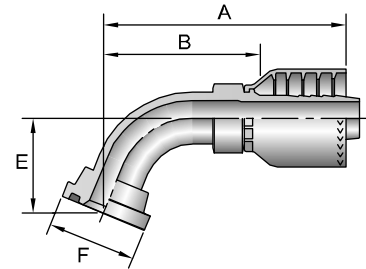

11 71

SAE Code 61 Flange Head - 0 Elbow
ISO 12151-3 - E90S - L (1 Piece: ISO 12151-3 - E90M - L)

# Part Number	Flange inch	Hose I.D. inch	A		E		F inch	B	
			inch	mm	inch	mm		inch	mm
11971-8-8	1/2	1/2	2.93	74	1.6	41	1-3/16	1.72	44
11971-10-10	5/8	5/8	3.62	92	2.10	53	1-11/32	2.37	60
11971-12-8	3/4	1/2	2.93	74	1.66	42	1-1/2	1.72	44
11971-12-10	3/4	5/8	3.62	92	2.10	53	1-1/2	2.37	60
11971-12-12	3/4	3/4	3.48	88	2.28	58	1-1/2	2.10	53
11971-16-12	1	3/4	3.52	89	2.28	58	1-3/4	2.14	54
11971-16-16	1	1	4.36	111	2.76	70	1-3/4	2.58	66
11971-16-20	1	1-1/4	4.53	115	2.39	61	1-3/4	2.75	70
11971-20-12	1-1/4	3/4	3.81	97	2.13	54	2	2.45	62
11971-20-16	1-1/4	1	4.33	110	2.76	70	2	2.55	65
11971-20-20	1-1/4	1-1/4	5.12	130	3.54	90	2	3.43	87
11971-20-24	1-1/4	1-1/2	6.33	161	3.00	76	2	4.14	105
11971-24-16	1-1/2	1	4.53	115	2.39	61	2-3/8	2.75	70
11971-24-20	1-1/2	1-1/4	5.09	129	3.54	90	2-3/8	3.40	86
11971-24-24	1-1/2	1-1/2	6.34	161	4.09	104	2-3/8	4.15	105
11971-32-24	2	1-1/2	5.84	148	3.12	79	2-13/16	3.65	93
11971-32-32	2	2	7.75	197	5.43	138	2-13/16	5.55	141
11971-40-32	2-1/2	2	7.43	189	4.5	114	3-5/16	5.23	133

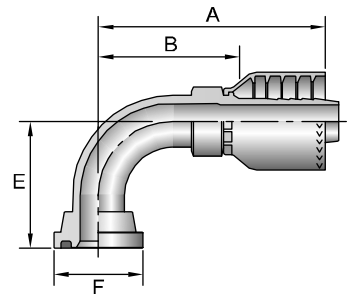

Must be assembled with Die Part No. 83C-D16H in a Superkrimp or Parkrimp 2.
Must be assembled with Die Part No. 83C-D20H in a Superkrimp or Parkrimp 2.
See Accessories for Flange its and O-Rings.

Hose
A

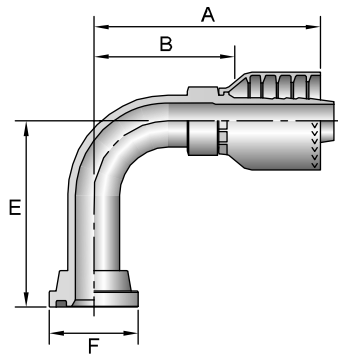

18 71

SAE Code 61 Flange Head - 0 Elbow - Long Drop

#			A		E			B	
Part Number	Flange inch	Hose I.D. inch	inch	mm	inch	mm	inch	inch	mm
18971-12-12	3/4	3/4	3.49	89	3.03	77	1-1/2	2.11	54
18971-16-16	1	1	4.52	115	4.60	117	1-3/4	2.74	70
18971-20-16	1-1/4	1	4.53	115	4.60	117	2	2.75	70

Fittings
71 Series
B

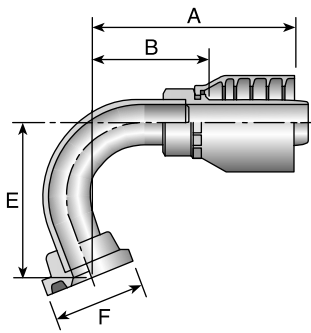

12 71

SAE Code 61 Flange Head - 110 Elbow

#			A		E			B	
Part Number	Flange inch	Hose I.D. inch	inch	mm	inch	mm	inch	inch	mm
12U71-16-16	1	1	4.49	114	3.69	94	1-3/4	2.71	69

Equipment
C

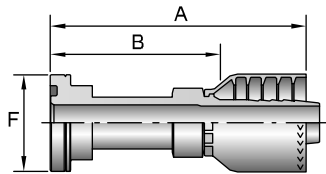

16A71

SAE Code 62 Flange Head
ISO 12151-3 - S - S

#			A			B	
Part Number	Flange inch	Hose I.D. inch	inch	mm	inch	inch	mm
16A71-12-12	3/4	3/4	4.31	109	1-5/8	2.93	74
16A71-16-12	1	3/4	3.10	78,7	1-7/8	1.72	43,7
16A71-16-16	1	1	4.89	124	1-7/8	3.11	79
16A71-20-16	1-1/4	1	3.69	93,7	2-1/8	1.91	48,5
16A71-20-20	1-1/4	1-1/4	5.01	127,3	2-1/8	3.32	84,3
16A71-24-24	1-1/2	1-1/2	6.34	161,0	2-1/2	4.15	105,4
16A71-32-32	2	2	7.16	182	3-1/8	4.96	126

Accessories
D

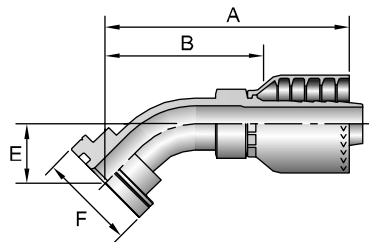

16F71

SAE Code 62 Flange Head - 45 Elbow
ISO 12151-3 - E45S - L (1 Piece: ISO 12151-3 - E45M - S)

#			A		E			B	
Part Number	Flange inch	Hose I.D. inch	inch	mm	inch	mm	inch	inch	mm
16F71-12-12	3/4	3/4	3.82	97	1.03	26	1-5/8	2.44	62
16F71-16-16	1	1	4.74	120,3	1.26	32	1-7/8	2.96	75,2
16F71-20-16	1-1/4	1	4.61	117	1.06	27	2-1/8	3.02	77
16F71-20-20	1-1/4	1-1/4	5.07	129	1.19	30	2-1/8	3.38	86
16F71-24-24	1-1/2	1-1/2	6.21	158	1.44	37	2-1/2	4.02	102
16F71-32-32	2	2	7.87	200	2.05	52	3-1/8	5.67	144

Technical
E

See Accessories for Flange its and O-Rings.

16N71

SAE Code 62 Flange Head - O Elbow
ISO 12151-3 - E90S - L (1 Piece: ISO 12151-3 - E90M - S)

# Part Number	Flange inch	Hose I.D. inch	A		E		F		B	
			inch	mm	inch	mm	inch	inch	inch	mm
16N71-12-12	3/4	3/4	3.51	89	2.28	58	1-5/8	2.13	54	
16N71-16-12	1	3/4	3.49	89	2.29	58	1-7/8	2.11	54	
16N71-16-16	1	1	4.36	111	2.76	70	1-7/8	2.58	66	
16N71-20-16	1-1/4	1	4.36	111	2.76	70	2-1/8	2.58	66	
16N71-20-20	1-1/4	1-1/4	5.09	129	3.54	90	2-1/8	3.40	86	
16N71-24-24	1-1/2	1-1/2	5.85	149	3.12	79	2-1/2	3.66	93	
16N71-32-32	2	2	7.73	196	4.50	114	3-1/8	5.53	140	

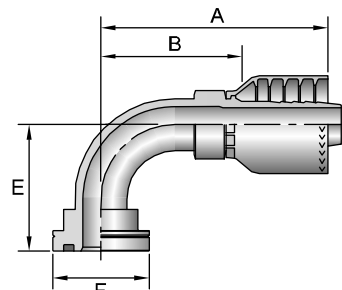

1J071

Male Seal-Lok - Rigid - (with O-Ring)
ISO 12151-1 - S

# Part Number	Thread inch		Hose I.D. inch	A		H inch	B	
	inch	inch		inch	mm		inch	mm
1J071-8-8	1/2	13/16x16	1/2	2.40	61	7/8	1.20	30
1J071-10-8	5/8	1x14	1/2	2.61	66	1-1/16	1.41	36
1J071-10-10	5/8	1x14	5/8	2.69	68	1-1/16	1.44	37
1J071-12-10	3/4	1-3/16x12	5/8	2.79	71	1-1/4	1.55	39
1J071-12-12	3/4	1-3/16x12	3/4	2.87	73	1-1/4	1.51	38
1J071-16-12	1	1-7/16x12	3/4	2.91	74	1-1/2	1.53	39
1J071-16-16	1	1-7/16x12	1	3.27	83	1-1/2	1.68	43
1J071-20-20	1-1/4	1-11/16x12	1-1/4	3.31	84	1-3/4	1.64	42
1J071-24-24	1-1/2	2x12	1-1/2	4.02	102	2-1/8	1.83	46

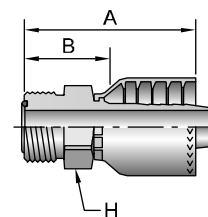

1JC71

Female Seal-Lok - Swivel - Short
ISO 12151-1 - SWSA

# Part Number	Thread inch		Hose I.D. inch	A		C		H		B	
	inch	inch		inch	mm	inch	mm	inch	inch	inch	mm
1JC71-8-8	1/2	13/16x16	1/2	2.22	56	0.43	11	13/16	15/16	1.01	26
1JC71-10-10	5/8	1x14	5/8	2.40	61	0.48	12	15/16	1-1/8	1.15	29
1JC71-12-12	3/4	1-3/16x12	3/4	2.68	68	0.55	14	1-1/8	1-3/8	1.30	33
1JC71-16-16	1	1-7/16x12	1	3.22	82	0.56	14	1-3/8	1-5/8	1.44	37
1JC71-20-16	1-1/4	1-11/16x12	1	3.16	80	0.59	15	1-5/8	1-7/8	1.38	35

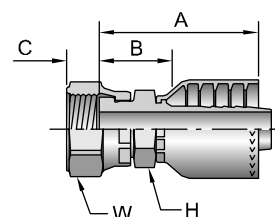

When measuring overall length to end of nut, B + C dimensions must be used to calculate cut-off allowance.

See Accessories for Flange Kits and O-Rings.

Hose
A

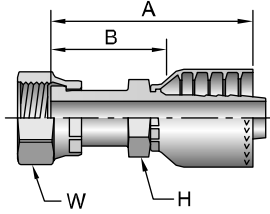

1JS71

Female Seal-Lok - Swivel - Long
ISO 12151-1 - SWSB

# Part Number	Thread		Hose I.D. inch	A		H		B	
	inch	inch		inch	mm	inch	inch	inch	mm
1JS71-6-6	3/8	11/16x16	3/8	2.80	58	11/16	13/16	1.38	35
1JS71-6-8	3/8	11/16x16	1/2	2.50	64	13/16	13/16	1.29	33
1JS71-8-8	1/2	13/16x16	1/2	2.64	67	13/16	15/16	1.44	37
1JS71-10-8	5/8	1x14	1/2	2.89	23	13/16	1-1/8	1.69	43
1JS71-10-10	5/8	1x14	5/8	3.00	76	15/16	1-1/8	1.75	44
1JS71-10-12	5/8	1x14	3/4	3.08	78	1-1/16	1-1/8	1.70	43
1JS71-12-10	3/4	1-3/16x12	5/8	3.10	79	1-1/8	1-3/8	1.85	47
1JS71-12-12	3/4	1-3/16x12	3/4	3.31	84	1-1/16	1-3/8	1.93	49
1JS71-16-12	1	1-7/16x12	3/4	3.37	86	1-5/16	1-5/8	1.99	51
1JS71-16-16	1	1-7/16x12	1	3.70	94	1-5/16	1-5/8	1.92	49
1JS71-20-16	1-1/4	1-11/16x12	1	3.64	92	1-3/4	1-7/8	1.94	49
1JS71-20-20	1-1/4	1-11/16x12	1-1/4	3.77	96	1-3/4	1-7/8	2.08	53
1JS71-24-24	1-1/2	2x12	1-1/2	4.51	114,6	2	2-1/4	2.32	58,9

Fittings
71 Series
B

1J771

Female Seal-Lok - Swivel - 45 Elbow
ISO 12151-1 - SWE45

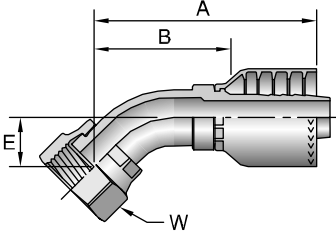

# Part Number	Thread		Hose I.D. inch	A		E		B		
	inch	inch		inch	mm	inch	mm	inch	mm	
1J771-6-6	3/8	11/16x16	3/8	2.34	59	0.43	11	13/16	1.44	37
1J771-8-8	1/2	13/16x16	1/2	2.83	72	0.59	15	15/16	1.62	41
1J771-10-8	5/8	1x14	1/2	2.93	74	0.63	16	1-1/8	1.72	44
1J771-10-10	5/8	1x14	5/8	3.08	78	0.63	16	1-1/8	1.83	46
1J771-12-12	3/4	1-3/16x12	3/4	3.63	92	0.83	21	1-3/8	2.25	57
1J771-16-16	1	1-7/16x12	1	4.46	113	0.94	24	1-5/8	2.68	68
1J771-20-20	1-1/4	1-11/16x12	1-1/4	4.75	121	1.00	25	1-7/8	3.08	78
1J771-24-24	1-1/2	2x12	1-1/2	5.43	138	1.07	27	2-1/4	3.23	82

Equipment
C

Accessories
D

Technical
E

Must be assembled with Die Part No. 83C-D16H in a Superkrimp or Parkrimp 2.
Must be assembled with Die Part No. 83C-D20H in a Superkrimp or Parkrimp 2.
See Accessories for O-Rings.

1J 71

Female Seal-Lok - Swivel - 0 Elbow - Short Drop
ISO 12151-1 - SWES90

# Part Number	Thread		Hose I.D. inch	A		E		B		
	inch			inch	mm	inch	mm	inch	inch	mm
1J971-6-6	3/8	11/16x16	3/8	2.21	56	0.91	23	13/16	1.31	33
1J971-8-8	1/2	13/16x16	1/2	2.59	66	1.14	29	15/16	1.38	35
1J971-10-8	5/8	1x14	1/2	2.74	70	1.26	32	1-1/8	1.53	39
1J971-10-10	5/8	1x14	5/8	2.88	73	1.26	32	1-1/8	1.63	41
1J971-10-12	5/8	1x14	3/4	3.07	78	1.27	32	1-1/8	1.70	43
1J971-12-10	3/4	1-3/16x12	5/8	3.40	86	1.89	48	1-3/8	2.15	55
1J971-12-12	3/4	1-3/16x12	3/4	3.49	89	1.89	48	1-3/8	2.11	54
1J971-16-16	1	1-7/16x12	1	4.36	111	2.20	56	1-5/8	2.58	66
1J971-20-20	1-1/4	1-11/16x12	1-1/4	4.86	123	2.51	64	1-7/8	3.19	81
1J971-24-24	1-1/2	2x12	1-1/2	6.22	158	2.68	68	2-1/4	4.03	102

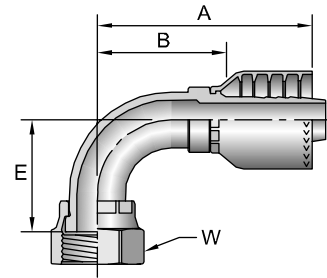

1J571

Female Seal-Lok - Swivel - 0 Elbow - Medium Drop
ISO 12151-1 - SWSB

# Part Number	Thread		Hose I.D. inch	A		E		B		
	inch			inch	mm	inch	mm	inch	inch	mm
1J571-8-8	1/2	13/16x16	1/2	2.59	66	1.61	41	15/16	1.38	35
1J571-10-10	5/8	1x14	5/8	2.88	73	1.85	47	1-1/8	1.63	41
1J571-12-12	3/4	1-3/16x12	3/4	3.49	89	2.28	58	1-3/8	2.11	54

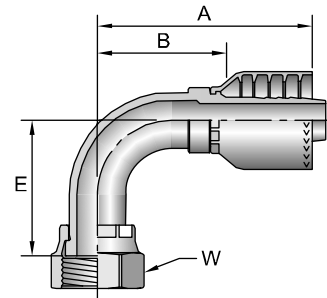

1J171

Female Seal-Lok - Swivel - 0 Elbow - Long Drop
ISO 12151-1 - SWEL90

# Part Number	Thread		Hose I.D. inch	A		E		B		
	inch			inch	mm	inch	mm	inch	inch	mm
1J171-6-6	3/8	11/16x16	3/8	2.39	61	2.13	54	13/16	1.49	38
1J171-8-8	1/2	13/16x16	1/2	2.59	66	2.52	64	15/16	1.38	35
1J171-10-10	5/8	1x14	5/8	2.88	73	2.76	70	1-1/8	1.63	41
1J171-12-12	3/4	1-3/16x12	3/4	3.49	89	3.78	96	1-3/8	2.11	54
1J171-16-12	1	1-7/16x12	3/4	4.07	103	4.50	114	1-5/8	2.69	68
1J171-16-16	1	1-7/16x12	1	4.36	111	4.49	114	1-5/8	2.58	66
1J171-20-20	1-1/4	1-11/16x12	1-1/4	4.88	124	5.09	129	1-7/8	3.19	81
1J171-24-24	1-1/2	2x12	1-1/2	5.83	148	5.54	141	2-1/4	3.64	92

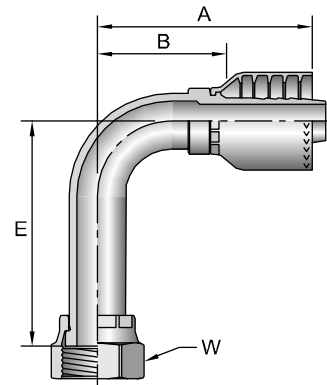

Must be assembled with Die Part No. 83C-D16H in a Superkrimp or Parkrimp 2.
Must be assembled with Die Part No. 83C-D20H in a Superkrimp or Parkrimp 2.
See Accessories for O-Rings.

Hose
A
 Fittings
 71 Series
B
 Equipment
C
 Accessories
D
 Technical
E

1D271
Male Metric S - Rigid - (24 Cone)
ISO 12151-2 - S - S

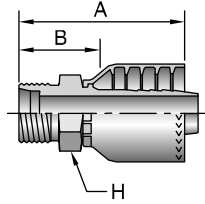

# Part Number	Thread mm	Hose I.D. inch	A		H mm	B	
			inch	mm		inch	mm
1D271-25-12	25 M36x2	3/4	2.90	74	36	1.52	39
1D271-30-16	30 M42x2	1	3.45	88	46	1.67	42

1C 71
Female Metric S - Swivel - (24 Cone with -Ring)
ISO 12151-2 - SWS - S

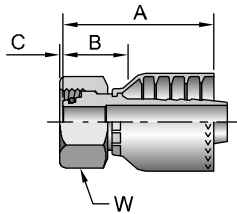

# Part Number	Thread mm	Hose I.D. inch	A		C		H mm	B	
			inch	mm	inch	mm		inch	mm
1C971-12-6	12 M20x1,5	3/8	1.99	51	0.03	1	24	1.17	30
1C971-16-8	16 M24x1,5	1/2	2.33	59	0.09	2	30	1.18	30
1C971-20-10	20 M30x2	5/8	2.55	65	0.05	1	36	1.39	35
1C971-25-12	25 M36x2	3/4	2.68	68	0.10	3	46	1.10	28
1C971-30-16	30 M42x2	1	3.07	78	0.19	5	50	1.30	33
1C971-38-20	38 M52x2	1-1/4	3.15	80	0.23	6	60	1.30	33

When measuring overall length to end of nut, B C dimensions must be used to calculate cut-off allowance.

1 T71
Male BSP Taper Pipe - Rigid - (60 Cone)

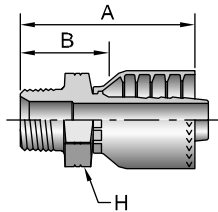

# Part Number	Hose I.D. inch	A		H mm	B	
		inch	mm		inch	mm
1UT71-8-8	1/2	2.66	68	27	1.46	37
1UT71-12-12	3/4	2.95	75	36	1.59	40

1 71
Female BSP Parallel Pipe - Swivel - (60 Cone)

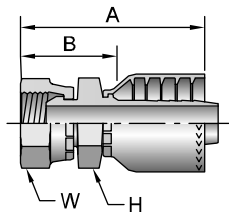

# Part Number	Thread inch	Hose I.D. inch	A		H		B	
			inch	mm	mm	mm	inch	mm
1 U71-6-6	3/8 3/8x19	3/8	2.45	62	22	22	1.55	39
1 U71-8-8	1/2 1/2x14	1/2	2.81	71	27	27	1.61	41
1 U71-12-12	3/4 3/4x14	3/4	3.24	82	36	36	1.86	47
1 U71-16-16	1 1x11	1	3.82	97	41	41	2.04	52
1 U71-20-20	1-1/4 1-1/4x11	1-1/4	4.07	103	50	50	2.38	60
1 U71-24-24	1-1/2 1-1/2x11	1-1/2	4.81	122	60	60	2.62	67
1 U71-32-32	2 2x11	2	5.17	131	70	70	2.97	75

Metric S: Mates with EO "S" Series Fittings.
 Must be assembled with Die Part No. 83C-D16H in a Superkrimp or Parkrimp 2.
 Must be assembled with Die Part No. 83C-D20H in a Superkrimp or Parkrimp 2.
 See Accessories for Flange its and O-Rings.

1F 71

Female BSP Parallel Pipe - Swivel - (30 Flare)

# Part Number	Thread inch	Hose I.D. inch	A		H		B	
			inch	mm	mm	mm	inch	mm
1FU71-6-6	3/8x19	3/8	2.39	61	24	22	1.50	38
1FU71-8-8	1/2x14	1/2	2.71	69	27	27	1.51	38
1FU71-12-12	3/4x14	3/4	3.10	79	36	36	1.74	44
1FU71-16-16	1x11	1	3.52	89	41	41	1.93	49
1FU71-20-20	1-1/4x11	1-1/4	3.87	98	50	50	2.20	56
1FU71-24-24	1-1/2x11	1-1/2	4.66	118	60	60	2.53	64

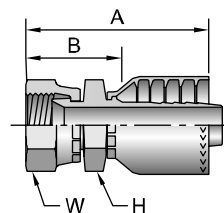

1M 71

Female Metric - Swivel - (30 Flare)

# Part Number	Thread inch	Hose I.D. inch	A		H		B	
			inch	mm	mm	mm	inch	mm
1MU71-6-6	M18x1,5	3/8	2.45	62	24	24	1.56	40
1MU71-8-8	M22x1,5	1/2	2.83	72	27	27	1.45	37

Japanese Fittings - Female Swivel 30 Flare with Metric Threads. All 30 flared fitting sizes are available by combining 1MU71 fittings in sizes up to 1/2 with 1XU71 fittings in sizes 5/8 inch and larger.

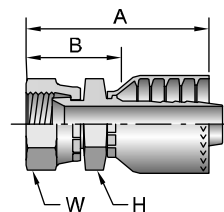

1 71

Female Metric - Swivel - (30 Flare)

# Part Number	Thread mm		Hose I.D. inch	A		H		B	
	inch	mm		inch	mm	mm	mm	inch	mm
1XU71-10-10	5/8	M24x1,5	5/8	3.16	80	30	32	1.91	49
1XU71-12-12	3/4	M30x1,5	3/4	3.40	86	32	36	2.02	51
1XU71-16-16	1	M33x1,5	1	4.11	104	36	41	2.33	59
1XU71-20-20	1-1/4	M36x1,5	1-1/2	4.19	106	46	46	2.50	64
1XU71-24-24	1-1/2	M42x1,5	1-1/2	5.00	127	50	55	2.80	71

Japanese Fittings - Female Swivel 30 Flare with Metric Threads. All 30 flared fitting sizes are available by combining 1MU71 fittings in sizes up to 1/2 with 1XU71 fittings in sizes 5/8 inch and larger.

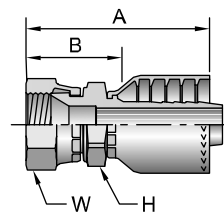

Hose
A

Fittings
71 Series
B

Equipment
C

Accessories
D

Technical
E

Hose

A

Fittings
71 Series

B

Equipment

C









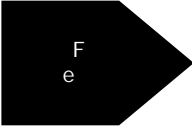
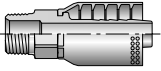
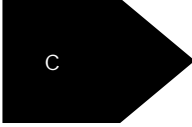
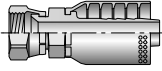
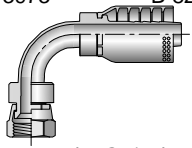

Accessories

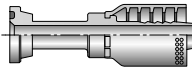
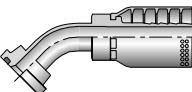
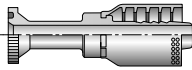
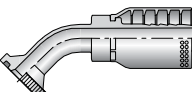
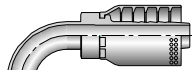
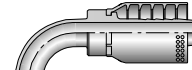
D

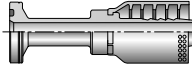
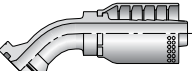
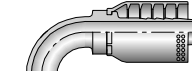
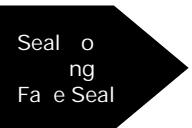
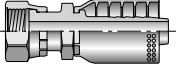
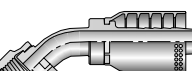
Technical

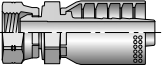
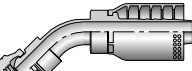
E

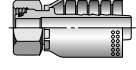
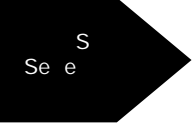
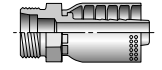
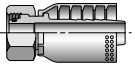
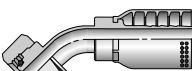
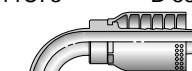

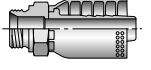
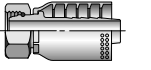
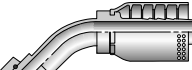
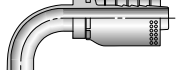
	10173 B-82  Male Rigid		10673 B-82  Female Swivel	13973 B-82  Female Swivel Elbow Short	
11573 B-82 	11773 B-83 	14A73 B-83 	14F73 B-83 	11973 B-83 	14N73 B-84 
	16A73 B-84 	16F73 B-84 	16N73 B-84 		1JS73 B-85 
1J773 B-85 	1J973 B-85 		1U73 B-86 	1173 B-86 	1273 B-86 
	1CA73 B-87 		1D273 B-87 	1C973 B-87 	10C73 B-87 
11C73 B-88 		1D973 B-88 	19273 B-88 	1B173 B-89 	1B273 B-89 

Hose
A

Fittings
73 Series
B

Equipment
C

Accessories
D

Technical
E

Hose
A

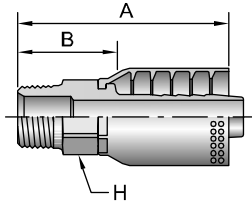

10173 Male NPTF Pipe - Rigid

# Part Number	Thread inch	Hose I.D. inch	A		H		B	
			inch	mm	inch	inch	inch	mm
10173-12-12	3/4x14	3/4	3.56	90	1-1/8	1.75	44	
10173-16-16	1x11-1/2	1	3.94	100	1-3/8	2.00	51	
10173-20-20	1-1/4x11-1/2	1-1/4	4.92	125	1-3/4	2.43	62	
10173-24-24	1-1/2x11-1/2	1-1/2	4.88	124	2	2.57	65	
10173-32-32	2x11-1/2	2	5.57	141	2-1/2	2.87	73	

Fittings
73 Series
B

10673 Female JIC 37 - Swivel

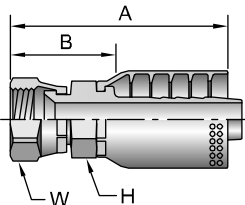

# Part Number	Thread inch		Hose I.D. inch	A		H		B	
	inch	inch		inch	mm	inch	inch	inch	mm
10673-12-12	3/4	1-1/16x12	3/4	3.66	93	1-1/8	1-1/4	1.85	47
10673-16-12	1	1-5/16x12	3/4	3.90	99	1-3/8	1-1/2	2.09	53
10673-16-16	1	1-5/16x12	1	4.03	102	1-3/8	1-1/2	2.09	53
10673-20-20	1-1/4	1-5/8x12	1-1/4	4.93	125	1-3/4	2	2.44	62
10673-24-24	1-1/2	1-7/8x12	1-1/2	5.04	128	2	2-1/4	2.73	69
10673-32-32	2	2-1/2x12	2	5.91	150	2-1/2	2-7/8	3.21	82

Note: All sizes of 10673 fittings are rated at 5,000 psi working pressure.

Equipment
C

13 73 Female JIC 37 - Swivel - 90° Elbow - Short Drop

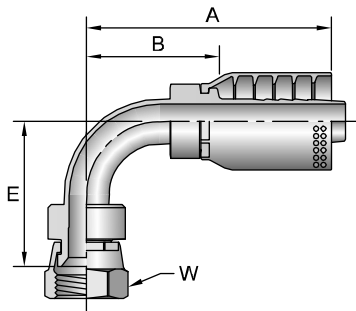

# Part Number	Thread inch		Hose I.D. inch	A		E		B		
	inch	inch		inch	mm	inch	mm	inch	mm	
13973-12-12	3/4	1-1/16x12	3/4	4.12	105	2.44	62	1-1/4	2.31	59
13973-16-16	1	1-5/16x12	1	4.71	120	2.93	74	1-1/2	2.77	70

Note: All sizes of 13973 fittings are rated at 5,000 psi working pressure.

Accessories
D

11573 SAE Code 61 Flange Head ISO 12151-3 - S - L

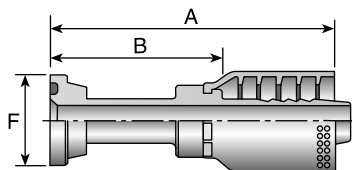

# Part Number	Flange inch	Hose I.D. inch	A		F		B	
			inch	mm	inch	inch	inch	mm
11573-12-12	3/4	3/4	4.34	110.2	1-1/2	2.53	64.3	
11573-16-16	1	1	4.59	117	1-3/4	2.65	67	

Technical
E

See Accessories for Flange nuts and O-Rings.



11773

SAE Code 61 Flange Head - 45 Elbow
ISO 12151-3 - E450S - L (1 Piece: ISO 12151-3 - E45M - L)

#	Part Number	Flange inch	Hose I.D. inch	A		E		F		B	
				inch	mm	inch	mm	inch	inch	mm	mm
	11773-12-12	3/4	3/4	4.31	109	1.02	26	1-1/2	2.50	64	
	11773-16-16	1	1	5.01	127	1.26	32	1-3/4	3.07	78	

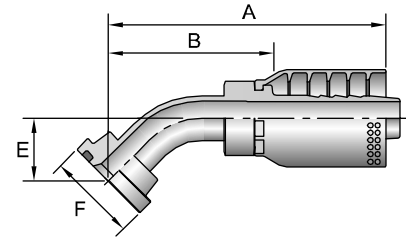

14A73

SAE Code 61 Flange Head - 5000 psi
ISO 12151-3 - S - L

#	Part Number	Flange inch	Hose I.D. inch	A		E		F		B	
				inch	mm	inch	mm	inch	inch	mm	mm
	14A73-20-20	1-1/4	1-1/4	5.54	141		2	3.05	77		
	14A73-24-24	1-1/2	1-1/2	6.53	166		2-3/8	4.22	107		
	14A73-32-32	2	2	6.14	156		2-13/16	3.44	87		

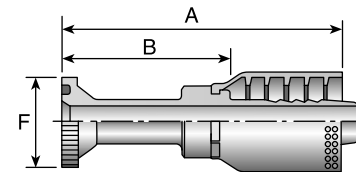

14F73

SAE Code 61 Flange Head - 45 Elbow - 5000 psi
ISO 12151-3 - E45S - L (1 Piece: ISO 12151-3 - E45M - L)

#	Part Number	Flange inch	Hose I.D. inch	A		E		F		B	
				inch	mm	inch	mm	inch	inch	mm	mm
	14F73-20-20	1-1/4	1-1/4	6.39	162	150	38	2	3.90	99	
	14F73-24-24	1-1/2	1-1/2	6.99	178	1.73	44	2-3/8	4.68	119	
	14F73-32-32	2	2	8.40	214	2.21	56	2-13/16	5.71	145	

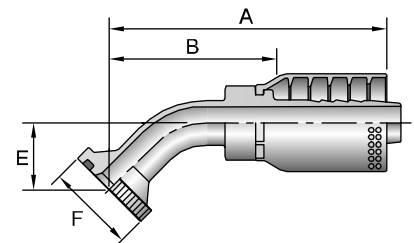

11 73

SAE Code 61 Flange Head - 0 Elbow
ISO 12151-3 - E90S - L (1 Piece: ISO 12151-3 - E90M - L)

#	Part Number	Flange inch	Hose I.D. inch	A		E		F		B	
				inch	mm	inch	mm	inch	inch	mm	mm
	11973-12-12	3/4	3/4	3.97	101	2.28	58	1-1/2	2.16	55	
	11973-16-12	1	3/4	4.00	102	2.28	58	1-3/4	2.19	56	
	11973-16-16	1	1	4.63	118	2.76	70	1-3/4	2.69	68	

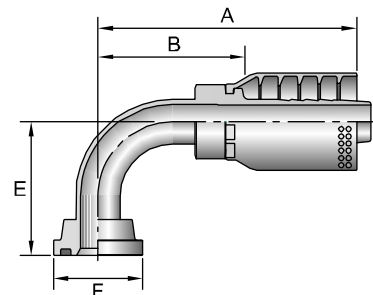

Hose

A

Fittings
73 Series

B

Equipment

C

Accessories

D

Technical

E

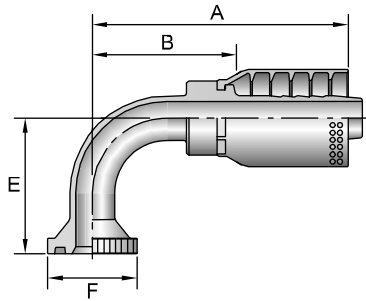

14N73

SAE Code 61 Flange Head - 0 Elbow - 5000 psi
ISO 12151-3 - E90S - L (1 Piece: ISO 12151-3 - E90M - L)

# Part Number	Flange inch	Hose I.D. inch	A		E		F	B	
			inch	mm	inch	mm		inch	mm
14N73-20-20	1-1/4	1-1/4	6.09	155	3.54	90	2	3.60	91
14N73-24-24	1-1/2	1-1/2	6.52	166	4.09	104	2-3/8	4.21	107
14N73-32-32	2	2	7.82	199	5.43	138	2-13/16	5.12	130

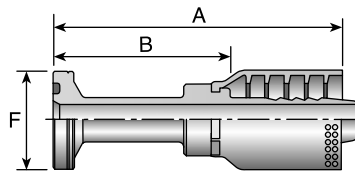

16A73

SAE Code 62 Flange Head
ISO 12151-3 - S - S

# Part Number	Flange inch	Hose I.D. inch	A		F	B	
			inch	mm		inch	mm
16A73-12-12	3/4	3/4	4.60	117	1-5/8	2.79	71
16A73-16-16	1	1	5.16	131	1-7/8	3.22	82
16A73-20-16	1-1/4	1	3.95	100	2-1/8	2.01	51
16A73-20-20	1-1/4	1-1/4	5.85	149	2-1/8	3.36	85
16A73-24-24	1-1/2	1-1/2	6.54	166	2-1/2	4.23	107
16A73-32-32	2	2	7.63	194	3-1/8	4.93	125

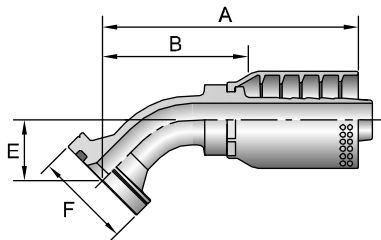

16F73

SAE Code 62 Flange Head - 45 Elbow
ISO 12151-3 - E45S - S (1 Piece: ISO 12151-3 - E45M - S)

# Part Number	Flange inch	Hose I.D. inch	A		E		F	B	
			inch	mm	inch	mm		inch	mm
16F73-12-12	3/4	3/4	4.31	109	1.02	26	1-5/8	2.50	64
16F73-16-16	1	1	5.01	127	1.26	32	1-7/8	3.07	78
16F73-20-20	1-1/4	1-1/4	6.39	162	1.50	38	2-1/8	3.90	99

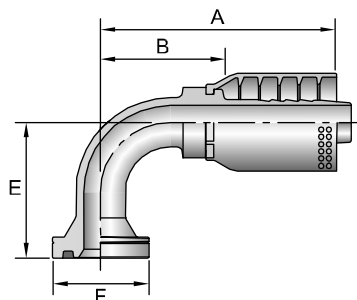

16N73

SAE Code 62 Flange Head - 0 Elbow
ISO 12151-3 - E90S - S (1 Piece: ISO 12151-3 - E90M - S)

# Part Number	Flange inch	Hose I.D. inch	A		E		F	B	
			inch	mm	inch	mm		inch	mm
16N73-12-12	3/4	3/4	3.97	101	2.28	58	1-5/8	2.16	55
16N73-16-16	1	1	4.63	118	2.76	70	1-7/8	2.69	68
16N73-20-20	1-1/4	1-1/4	6.09	151	3.54	90	2-1/8	3.60	91
16N73-24-24	1-1/2	1-1/2	6.52	166	4.09	104	2-1/2	4.21	107
16N73-32-32	2	2	7.82	199	5.43	138	3-1/8	5.12	130

A Hose

B Fittings
73 Series

C Equipment

D Accessories

E Technical

1JS73

Female Seal-Lok - Swivel - Long
ISO 12151-1 - SWSB

# Part Number	Thread		Hose I.D. inch	A		H		B	
	inch	inch		inch	mm	inch	inch	inch	mm
1JS73-12-12	3/4	1-3/16x12	3/4	3.70	94	1-1/8	1-3/8	1.89	48
1JS73-16-12	1	1-7/16x12	3/4	3.78	96	1-3/8	1-5/8	1.97	50
1JS73-16-16	1	1-7/16x12	1	4.03	102	1-3/8	1-5/8	2.09	53
1JS73-20-20	1-1/4	1-11/16x12	1-1/4	4.62	132	1-3/4	1-7/8	2.13	69

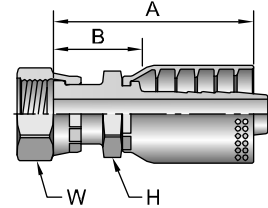

1J773

Female Seal-Lok - Swivel - 45 Elbow
ISO 12151-1 - SWE45

# Part Number	Thread		Hose I.D. inch	A		E		B		
	inch	inch		inch	mm	inch	mm	inch	mm	
1J773-12-12	3/4	1-3/16x12	3/4	4.11	104	0.81	21	1-3/8	2.30	58
1J773-16-16	1	1-7/16x12	1	4.69	119	0.94	24	1-5/8	2.75	70
1J773-20-20	1-1/4	1-11/16x12	1-1/4	5.78	147	0.98	25	1-7/8	3.29	84

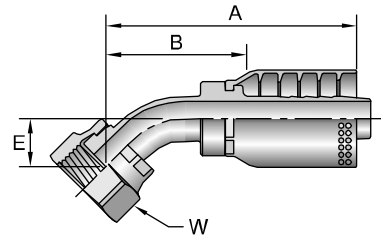

1J 73

Female Seal-Lok - Swivel - 90 Elbow - Short Drop
ISO 12151-1 - SWES90

# Part Number	Thread		Hose I.D. inch	A		E		B		
	inch	inch		inch	mm	inch	mm	inch	mm	
1J973-12-12	3/4	1-3/16x12	3/4	3.97	100	1.89	48	1-3/8	2.16	55
1J973-16-16	1	1-7/16x12	1	4.62	117	2.20	56	1-5/8	2.68	68
1J973-20-20	1-1/4	1-11/16x12	1-1/4	5.82	148	2.52	64	1-7/8	3.33	85

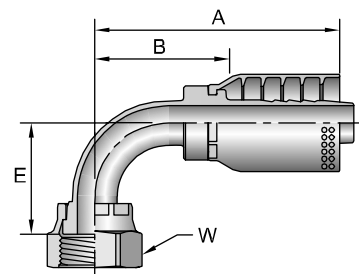

Metric S: Mates with EO "S" Series Fittings.

Hose
A
Fittings
73 Series
B
Equipment
C
Accessories
D
Technical
E

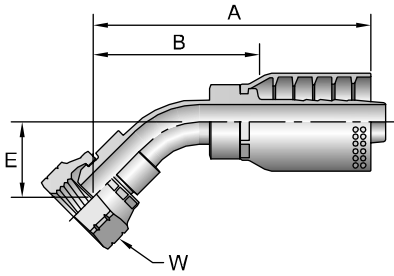

1 173
Female BSP Parallel Pipe - Swivel - 45 Elbow - (60 Cone)

# Part Number	Thread inch	Hose I.D. inch	A		E		mm	B	
			inch	mm	inch	mm		inch	mm
1 173-12-12	3/4x14	3/4	4.77	121,2	1.35	34,4	36	2.96	75,2
1 173-16-16	1x11	1	5.36	136,1	1.52	38,7	41	3.42	86,9

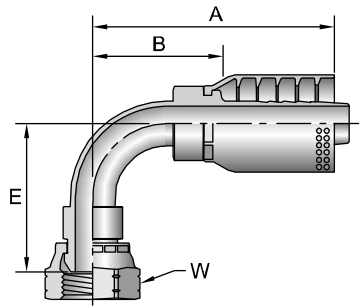

1 273
Female BSP Parallel Pipe - Swivel - 90 Elbow - (60 Cone)

# Part Number	Thread inch	Hose I.D. inch	A		E		mm	B	
			inch	mm	inch	mm		inch	mm
1 273-12-12	3/4x14	3/4	4.12	104,6	2.62	66,6	36	2.31	58,7
1 273-16-16	1x11	1	4.71	119,6	3.04	77,2	41	2.77	70,4

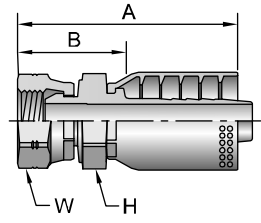

1 73
Female BSP Parallel Pipe - Swivel - (60 Cone)

# Part Number	Thread inch	Hose I.D. inch	A		H		B	
			inch	mm	mm	mm	inch	mm
1 U73-12-12	3/4x14	3/4	3.76	95,5	36	36	1.95	49,5
1 U73-16-16	1x11	1	4.14	105	41	41	2.20	56

Metric S: Mates with EO "S" Series Fittings
Must use Parkrimp 2 with Die Part No. 83C-L20.



1CA73

Female Metric L - Swivel - (24° Cone with -Ring)
ISO 12151-2 - SWS

# Part Number	Thread mm	Hose I.D. inch	A		C		mm	B	
			inch	mm	inch	mm		inch	mm
1CA73-28-16	25 M36x2	1	3.43	87	0.14	3.56	41	1.42	36

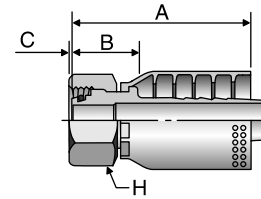

1D273

Male Metric S - Rigid - (24° Cone)
ISO 8434-1

# Part Number	Thread mm	Hose I.D. inch	A		H mm	B	
			inch	mm		inch	mm
1D273-20-12	20 M30x2	3/4	3.31	84	30	1.42	36
1D273-25-12	28 M36x2	3/4	3.39	86	36	1.50	38
1D273-30-16	30 M42x2	1	3.70	94	46	1.73	44
1D273-38-20	38 M52x2	1-1/4	4.41	112	55	1.89	48

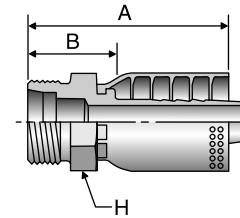

1C 73

Female Metric S - Swivel - (24° Cone with -Ring)
ISO 12151-2 - SWS

# Part Number	Thread mm	Hose I.D. inch	A		C		mm	B	
			inch	mm	inch	mm		inch	mm
1C973-20-12	20 M30x2	3/4	3.19	81	0.05	1.3	36	1.30	33
1C973-25-12	25 M36x2	3/4	3.15	80	0.09	2.3	46	1.26	32
1C973-25-16	25 M36x2	1	3.43	87	0.09	2.3	46	1.42	36
1C973-30-16	30 M42x2	1	3.43	87	0.19	4.8	50	1.42	36
1C973-30-20	30 M42x2	1-1/4	4.17	106	0.19	4.8	50	1.65	42
1C973-38-20	38 M52x2	1-1/4	4.02	102	0.23	5.8	60	1.38	35

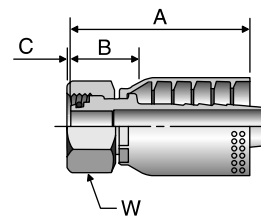

10C73

Female Metric S - Swivel - 45° Elbow - (24° Cone with -Ring)
ISO 12151-2 - SWE45 - S

# Part Number	Thread mm	Hose I.D. inch	A		E		mm	B	
			inch	mm	inch	mm		inch	mm
10C73-20-12	20 M30x2	3/4	4.41	112	1.10	28	36	2.52	64
10C73-25-12	25 M36x2	3/4	4.45	113	1.14	29	46	2.56	65
10C73-30-16	30 M42x2	1	5.16	131	1.34	34	50	3.19	81

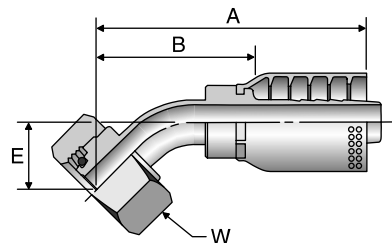

Hose
A

Fittings
73 Series
B

Equipment
C

Accessories
D

Technical
E

Hose
A

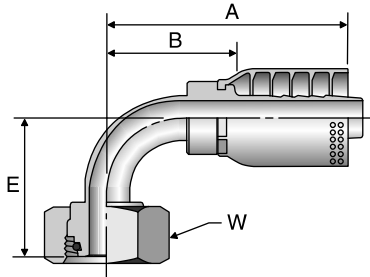

11C73

Female Metric S - Swivel - 90° Elbow - (24° Cone with 1/2" Ring)
ISO 12151-2 - SWE - S

# Part Number	Thread mm	Hose I.D. inch	A		E		mm	B	
			inch	mm	inch	mm		inch	mm
11C73-20-12	20 M30X2	3/4	3.98	101	2.24	57	36	2.09	53
11C73-25-12	25 M36X2	3/4	3.98	101	2.32	59	46	2.05	52
11C73-25-16	25 M36X2	1	4.80	122	2.76	70	46	2.80	71
11C73-30-16	30 M42X2	1	4.80	122	2.87	73	50	2.83	72
11C73-38-20	38 M52X2	1-1/4	5.94	151	3.07	78	60	3.43	87

Fittings
73 Series
B

1D 73

Male BSP Parallel Pipe - Rigid - (60° Cone)
ISO 228-1

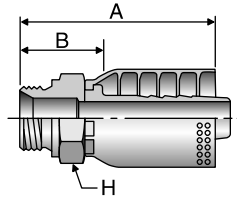

# Part Number	Thread BSP	Hose I.D. inch	A		H mm	B	
			inch	mm		inch	mm
1D973-12-12	19,1 3/4x14	3/4	3.43	87	32	1.50	38
1D973-16-16	25,4 1x11	1	3.74	95	41	1.69	43

Equipment
C

1 273

Female BSP Parallel Pipe - Swivel - (60° Cone)
ISO 228-1

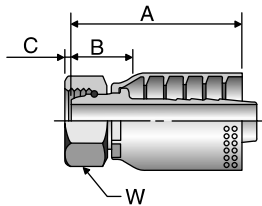

# Part Number	Thread inch	Hose I.D. inch	A		C		mm	B	
			inch	mm	inch	mm		inch	mm
19273-12-12	3/4x14	3/4	3.03	77	0.46	11.7	32	1.14	29
19273-16-16	1x11	1	3.50	89	0.44	11.2	41	1.50	38
19273-20-20	1-1/4x11	1-1/4	3.98	101	0.52	13.2	50	1.46	37

Accessories
D

Technical
E

1B173

Female BSP Parallel Pipe - Swivel- 45° Elbow - (60° Cone)
ISO 228-1

# Part Number	Thread inch	Hose I.D. inch	A		E		mm	B	
			inch	mm	inch	mm		inch	mm
1B173-12-12	3/4x14	3/4	4.33	110	1.02	26	32	2.44	62
1B173-16-16	1x11	1	5.35	136	1.54	39	41	3.31	84

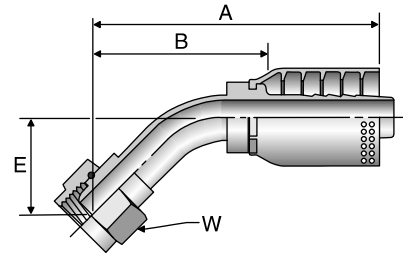

1B273

Female BSP Parallel Pipe - Swivel - 0° Elbow - (60° Cone)
ISO 228-1

# Part Number	Thread inch	Hose I.D. inch	A		E		mm	B	
			inch	mm	inch	mm		inch	mm
1B273-12-12	3/4x14	3/4	4.17	106	2.17	55	32	2.28	58
1B273-16-16	1x11	1	4.76	121	2.99	76	41	2.76	70
1B273-20-20	1-1/4x11	1-1/4	5.94	151	3.15	80	50	3.43	87

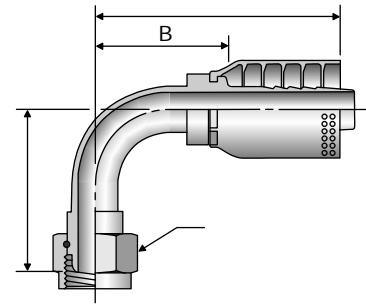

Hose
A

Fittings
73 Series
B

Equipment
C

Accessories
D

Technical
E

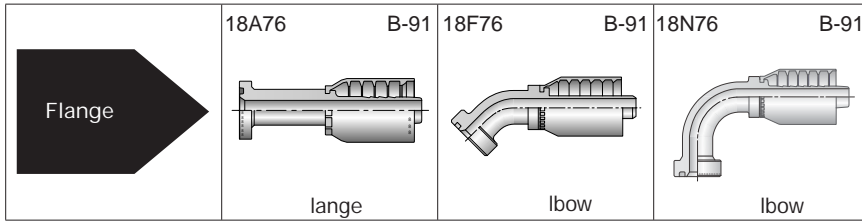

Hose
A

Fittings
76 Series
B



Equipment
C

Accessories
D

Technical
E

18A76

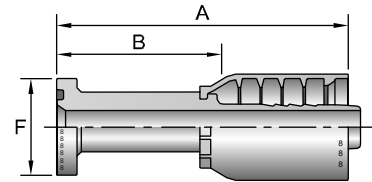

Flange Head - 8 000 psi

#			A			B	
			inch	mm		inch	mm
18A76-12-12	3/4	3/4	5.29	134	1-5/8	2.96	75
18A76-16-16	1	1	5.72	145	1-7/8	3.17	81



18F76

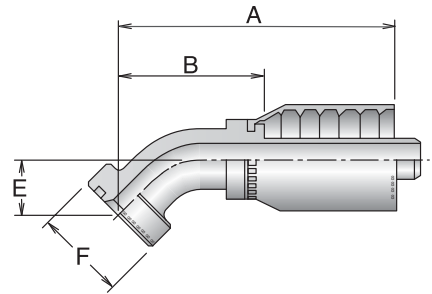

Flange Head - 45 Elbow - 8 000 psi

#			A		E			B	
			inch	mm	inch	mm		inch	mm
18F76-12-12	3/4	3/4	4.95	125,7	1.024	26	1-5/8	2.62	66,5
18F76-16-16	1	1	6.10	155,0	1.260	32	1-7/8	3.55	90,1



18N76





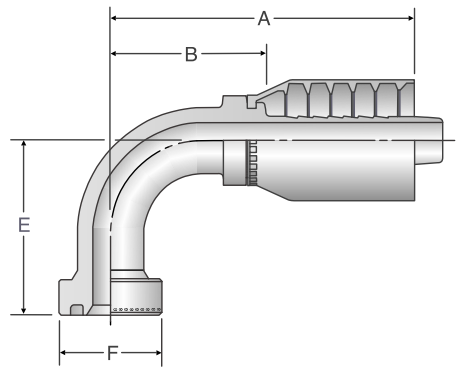





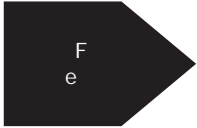
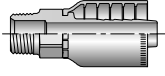

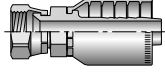
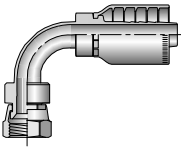
Flange Head - 90 Elbow - 8 000 psi

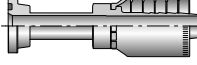
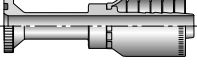
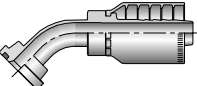
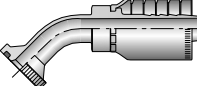
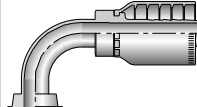
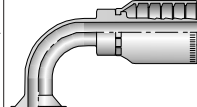

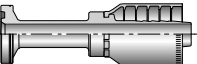
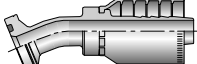
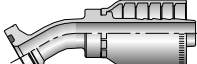
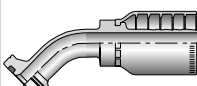
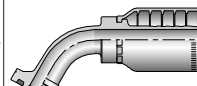
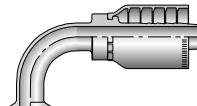

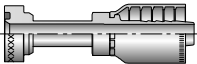
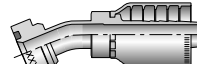
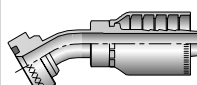
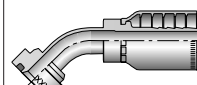
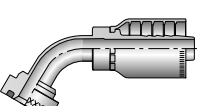
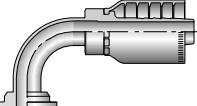
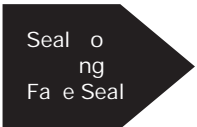
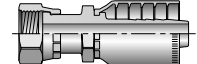
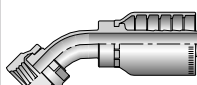

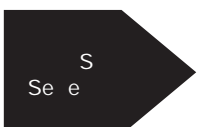
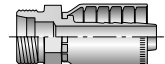
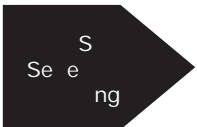
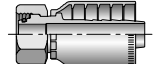
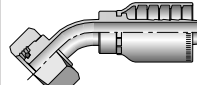
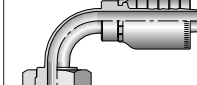

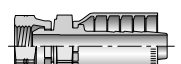
#			A		E			B	
			inch	mm	inch	mm		inch	mm
18N76-12-12	3/4	3/4	4.81	122,1	2.76	70	1-5/8	2.48	63
18N76-16-16	1	1	5.88	149,5	2.76	70	1-7/8	3.33	84,6

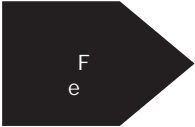
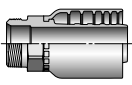

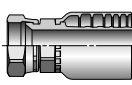
See Accessories for O-Rings and Flange fits.

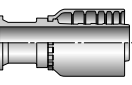
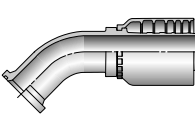
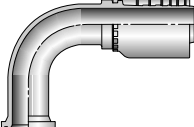
A Hose
 B Fittings
 C Equipment
 D Accessories
 E Technical

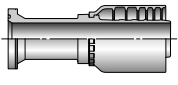
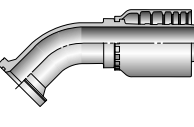
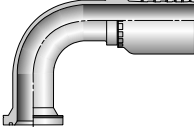
	10178 B-94  Male Rigid		10678 B-94  Female Swivel	13978 B-94  Female Swivel	
11578 B-94  Male Rigid	14A78 B-95  Male Rigid	11778 B-95  Female Swivel	14F78 B-95  Female Swivel	11978 B-95  Female Swivel	14N78 B-96  Female Swivel
	16A78 B-96  Male Rigid	16B78 B-96  Female Swivel	16E78 B-96  Female Swivel	16F78 B-97  Female Swivel	16G78 B-97  Female Swivel
16N78 B-97  Female Swivel		1XA78 B-98  Male Rigid	1XB78 B-98  Female Swivel	1XE78 B-98  Female Swivel	1XF78 B-99  Female Swivel
1XG78 B-99  Female Swivel	1XN78 B-99  Female Swivel		1JS78 B-100  Female Swivel	1J778 B-100  Female Swivel	1J978 B-100  Female Swivel
	1D278 B-101  Male Rigid		1C978 B-101  Female Rigid	10C78 B-101  Female Swivel	11C78 B-101  Female Swivel
	1GU78 B-101  Female Swivel				

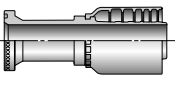
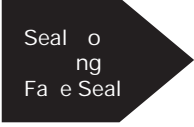
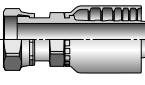
 Female Flange	101S6 B-102  Female Rigid	 C	106S6 B-102  Female Swivel	 Co e Flange	14AS6 B-102  Flange psi
14FS6 B-102  lbow psi	14NS6 B-102  lbow psi	 Co e Flange	16AS6 B-103  Flange Head Straight	16FS6 B-103  lbow	16NS6 B-103  lbow
 Cate lla Flange	1XAS6 B-103  Flange	 Seal o ng Fa e Seal	1JSS6 B-103  Female Swivel		

Hose
A

Fittings
B

Equipment
C

Accessories
D

Technical
E

Hose
A

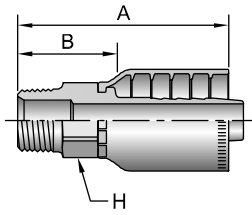

10178 Male NPTF Pipe - Rigid

# Part Number	Thread inch	Hose I.D. inch	A		H		B	
			inch	mm	inch	inch	inch	mm
10178-12-12	3/4x14	3/4	3.56	90	1-1/8	1.80	46	
10178-16-16	1x11-1/2	1	3.94	100	1-3/8	2.09	53	
10178-20-20	1-1/4x11-1/2	1-1/4	4.92	125	1-3/4	2.53	64	
10178-24-24	1-1/2x11-1/2	1-1/2	4.88	124	2	2.67	68	

Fittings
78 Series
B

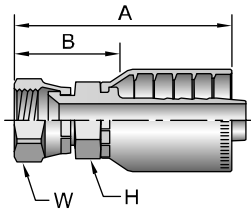

10678 Female JIC 37 - Swivel

# Part Number	Thread inch	Hose I.D. inch	A		H		B		Additional Material Stainless Steel (C)
			inch	mm	inch	inch	inch	mm	
10678-12-12	3/4	3/4	3.66	93	1-1/8	1-1/4	1.90	48	
10678-16-12	1	3/4	3.90	99	1-3/8	1-1/2	2.14	54	
10678-16-16	1	1	4.03	102	1-3/8	1-1/2	2.18	55	
10678-20-20	1-1/4	1-1/4	4.93	125	1-3/4	2	2.54	65	
10678-24-24	1-1/2	1-1/2	5.04	128	2	2-1/4	2.83	72	

All sizes of 10678 fittings are rated at 5,000 psi working pressure.

Equipment
C

13 78 Female JIC 37 - Swivel - 90° Elbow - Short Drop

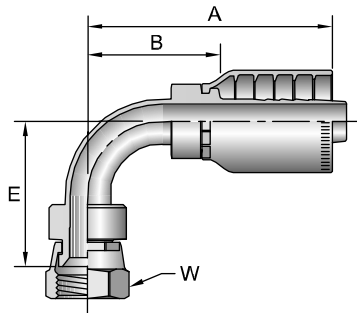

# Part Number	Thread inch	Hose I.D. inch	A		E		B		
			inch	mm	inch	mm	inch	mm	
13978-12-12	3/4	3/4	4.12	105	2.44	62	1-1/2	2.36	60
13978-16-16	1	1	4.71	120	2.93	74	1-1/2	2.86	73
13978-20-20	1-1/4	1-1/4	5.67	144	3.35	85	2	3.28	83

All sizes of 13978 fittings are rated at 5,000 psi working pressure.

Accessories
D

11578 SAE Code 61 Flange Head ISO 12151-3 - S - L

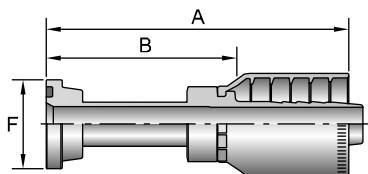

# Part Number	Flange inch	Hose I.D. inch	A		F inch	B	
			inch	mm		inch	mm
11578-12-12	3/4	3/4	4.34	110	1-1/2	2.58	66
11578-16-16	1	1	4.59	117	1-3/4	2.74	70

See Accessories for O-Rings and Flange kits.

Technical
E

14A78

SAE Code 61 Flange Head - 5 000 psi
ISO 12151-3 - S - L (5000 psi)

# Part Number	Flange inch	Hose I.D. inch	A		F inch	B	
			inch	mm		inch	mm
14A78-20-20	1-1/4	1-1/4	5.54	141	2	3.15	80
14A78-24-24	1-1/2	1-1/2	6.53	166	2-3/8	4.32	110
14A78-32-24	2	1-1/2	4.68	119	2-13/16	2.47	63

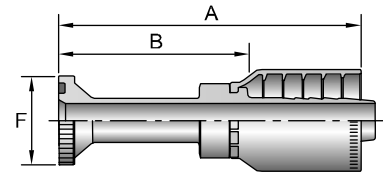

11778

SAE Code 61 Flange Head - 45 Elbow
ISO 12151-3 - E45S - L (1 Piece: ISO 12151-3 - E45M - L)

# Part Number	Flange inch	Hose I.D. inch	A		E		F inch	B	
			inch	mm	inch	mm		inch	mm
11778-12-12	3/4	3/4	4.67	119	1.06	27	1-1/2	2.91	74
11778-16-16	1	1	5.01	127	1.26	32	1-3/4	3.16	80

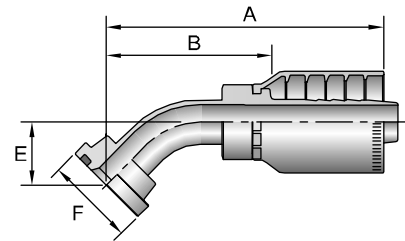

14F78

SAE Code 61 Flange Head - 45 Elbow - 5 000 psi
ISO 12151-3 - E45S - L (1 Piece: ISO 12151-3 - E45M - L) (5000 psi)

# Part Number	Flange inch	Hose I.D. inch	A		E		F inch	B	
			inch	mm	inch	mm		inch	mm
14F78-20-20	1-1/4	1-1/4	6.39	162	1.50	38	2	4.00	102
14F78-24-24	1-1/2	1-1/2	6.99	178	1.73	44	2-3/8	4.78	121

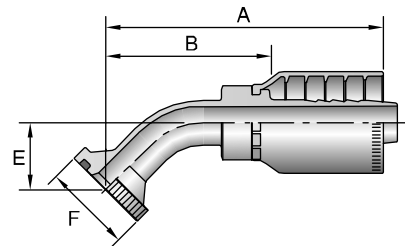

11 78

SAE Code 61 Flange Head - 90 Elbow
ISO 12151-3 - E90S - L (1 Piece: ISO 12151-3 - E90M - L)

# Part Number	Flange inch	Hose I.D. inch	A		E		F inch	B	
			inch	mm	inch	mm		inch	mm
11978-12-12	3/4	3/4	4.35	110	2.25	57	1-1/2	2.59	66
11978-16-16	1	1	4.67	119	2.76	70	1-3/4	2.82	72

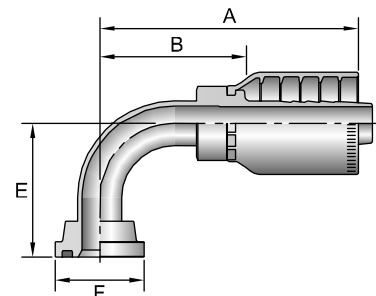

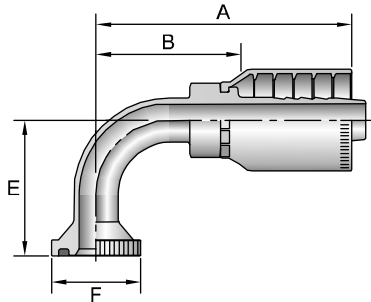

See Accessories for O-Rings and Flange its.

Hose
A



14N78

SAE Code 61 Flange Head - 0 Elbow - 5 000 psi
ISO 12151-3 - E90S - L (1 Piece: ISO 12151-3 - E90M - L) (5000 psi)

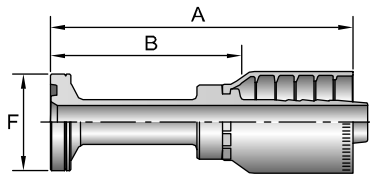

#			A		E		F		B	
Part Number	Flange inch	Hose I.D. inch	inch	mm	inch	mm	inch	inch	mm	
14N78-20-16	1-1/4	1	4.63	118	2.76	70	2	2.78	71	
14N78-20-20	1-1/4	1-1/4	6.09	155	3.54	90	2	3.70	94	
14N78-24-24	1-1/2	1-1/2	6.52	166	4.09	104	2-3/8	4.31	109	

Fittings
78 Series
B



16A78

SAE Code 62 Flange Head
ISO 12151-3 - S - S

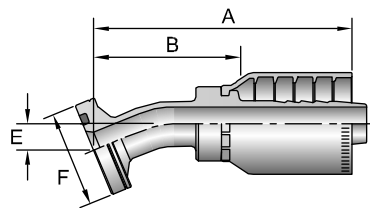

#			A		F	B	
Part Number	Flange inch	Hose I.D. inch	inch	mm	inch	inch	mm
16A78-12-12	3/4	3/4	4.60	117	1-5/8	2.84	72
16A78-16-12	1	3/4	3.57	91	1-7/8	1.81	46
16A78-16-16	1	1	5.16	131	1-7/8	3.31	84
16A78-20-16	1-1/4	1	3.95	100	2-1/8	2.10	53
16A78-20-20	1-1/4	1-1/4	5.85	149	2-1/8	3.46	88
16A78-24-20	1-1/2	1-1/4	4.77	121	2-1/2	2.38	60
16A78-24-24	1-1/2	1-1/2	6.54	166	2-1/2	4.33	110
16A78-32-24	2	1-1/2	5.07	129	3-1/8	2.86	73

Equipment
C



16B78

SAE Code 62 Flange Head - 22-1 2 Elbow
ISO 12151-3 - E22M - S

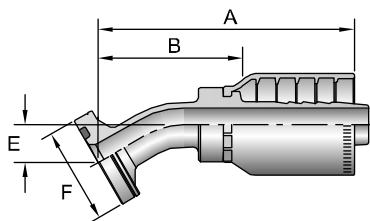

#			A		E		F	B	
Part Number	Flange inch	Hose I.D. inch	inch	mm	inch	mm	inch	inch	mm
16B78-16-16	1	1	4.57	116	0.46	12	1-7/8	2.72	60

Accessories
D



16E78

SAE Code 62 Flange Head - 30 Elbow
ISO 12151-3 - E30S - S (1 Piece: ISO 12151-3 - E30M - S)

#			A		E		F	B	
Part Number	Flange inch	Hose I.D. inch	inch	mm	inch	mm	inch	inch	mm
16E78-20-20	1-1/4	1-1/4	6.71	170	0.87	22	2-1/8	4.32	110
16E78-24-24	1-1/2	1-1/2	7.10	180	1.12	28	2-1/2	4.89	124



Technical
E

See Accessories for O-Rings and Flange fits.

16F78

SAE Code 62 Flange Head - 45 Elbow

ISO 12151-3 - E45S - S (1 Piece: ISO 12151-3 - E45M - S)

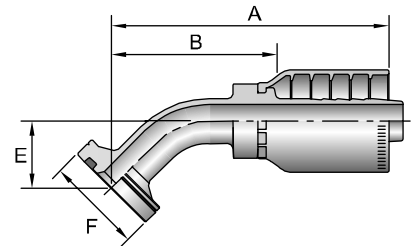

#			A		E			B	
			inch	mm	inch	mm		inch	mm
16F78-12-12	3/4	3/4	4.31	109	1.02	26	1-5/8	2.55	65
16F78-16-12	1	3/4	4.83	123	1.22	31	1-7/8	3.07	78
16F78-16-16	1	1	5.04	128	1.26	32	1-7/8	3.19	81
16F78-20-16	1-1/4	1	5.01	127	1.26	32	2-1/8	3.16	80
16F78-20-20	1-1/4	1-1/4	6.39	162	1.50	38	2-1/8	4.00	102
16F78-24-20	1-1/2	1-1/4	6.39	162	1.50	38	2-1/2	4.00	102
16F78-24-24	1-1/2	1-1/2	6.99	178	1.73	44	2-1/2	4.78	121



16 78

SAE Code 62 Flange Head - 60 Elbow

ISO 12151-3 - E60S - S (1 Piece: ISO 12151-3 - E60M - S)

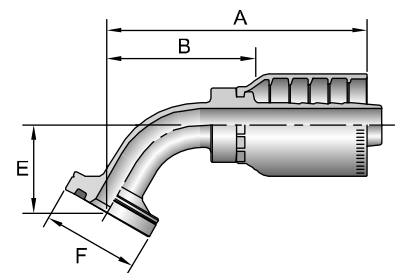

#			A		E			B	
			inch	mm	inch	mm		inch	mm
16 78-16-16	1	1	5.85	149	1.73	44	1-7/8	4.00	102
16 78-20-20	1-1/4	1-1/4	7.72	196	2.17	55	2-1/8	5.33	135
16 78-24-24	1-1/2	1-1/2	8.41	214	2.52	64	2-1/2	6.20	157



16N78

SAE Code 62 Flange Head - 90 Elbow

ISO 12151-3 - E90S - S (1 Piece: ISO 12151-3 - E90M - S)

#			A		E			B	
			inch	mm	inch	mm		inch	mm
16N78-12-12	3/4	3/4	4.00	102	2.28	58	1-5/8	2.24	57
16N78-16-12	1	3/4	3.97	101	2.28	58	1-7/8	2.21	56
16N78-16-16	1	1	4.63	118	2.76	70	1-7/8	2.78	71
16N78-20-16	1-1/4	1	4.63	118	2.76	70	2-1/8	2.78	71
16N78-20-20	1-1/4	1-1/4	6.09	155	3.54	90	2-1/8	3.70	94
16N78-24-16	1-1/2	1	5.04	126	2.70	69	2-1/2	3.19	81
16N78-24-20	1-1/2	1-1/4	6.09	155	3.54	90	2-1/2	3.70	94
16N78-24-24	1-1/2	1-1/2	6.52	166	4.09	104	2-1/2	4.31	109
16N78-32-24	2	1-1/2	6.52	166	4.09	104	3-1/8	4.31	109

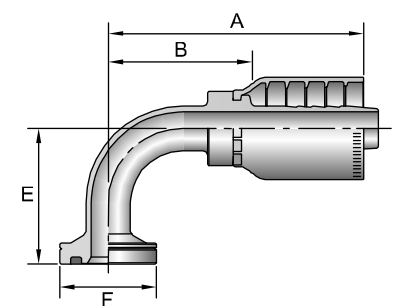

See Accessories for O-Rings and Flange fits.

Hose
A

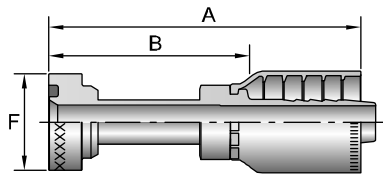

1 A78 Caterpillar Flange Head

# Part Number	Flange inch	Hose I.D. inch	A		F inch	B	
			inch	mm		inch	mm
1XA78-12-12	3/4	3/4	4.85	123,2	1-5/8	3.09	78,5
1XA78-16-12	1	3/4	5.29	134,4	1-7/8	3.53	89,7
1XA78-16-16	1	1	5.44	138,2	1-7/8	3.59	91,2
1XA78-20-16	1-1/4	1	5.65	143,5	2-1/8	3.80	96,5
1XA78-20-20	1-1/4	1-1/4	6.10	154,9	2-1/8	3.71	94,2
1XA78-24-20	1-1/2	1-1/4	6.35	161,3	2-1/2	3.96	100,6
1XA78-24-24	1-1/2	1-1/2	6.78	172,2	2-1/2	4.57	116,1

Fittings
78 Series
B

1 B78 Caterpillar Flange Head - 22-1 2 Elbow

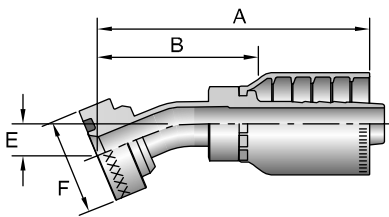

# Part Number	Flange inch	Hose I.D. inch	A		E		F inch	B	
			inch	mm	inch	mm		inch	mm
1XB78-12-12	3/4	3/4	4.59	117	0.54	14	1-5/8	2.83	72
1XB78-16-16	1	1	4.66	118	0.50	13	1-7/8	2.81	71
1XB78-20-16	1-1/4	1	4.66	118	0.50	13	2-1/8	2.81	71
1XB78-20-20	1-1/4	1-1/4	7.21	183	0.80	20	2-1/8	4.82	122
1XB78-24-20	1-1/2	1-1/4	7.21	183	0.80	20	2-1/2	4.82	122
1XB78-24-24	1-1/2	1-1/2	7.08	180	0.73	19	2-1/2	4.87	124

Equipment
C

1 E78 Caterpillar Flange Head - 30 Elbow

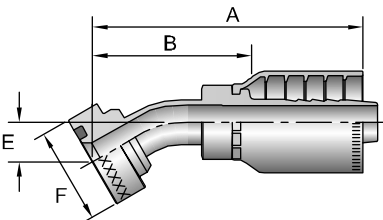

# Part Number	Flange inch	Hose I.D. inch	A		E		F inch	B	
			inch	mm	inch	mm		inch	mm
1XE78-16-16	1	1	5.08	129	0.79	20	1-7/8	3.23	82
1XE78-20-16	1-1/4	1	5.10	128	0.80	20	2-1/8	3.25	83
1XE78-20-20	1-1/4	1-1/4	6.38	162	0.93	24	2-1/8	3.99	101
1XE78-24-20	1-1/2	1-1/4	6.38	162	0.93	24	2-1/2	3.99	101
1XE78-24-24	1-1/2	1-1/2	7.10	180	1.14	29	2-1/2	4.89	124

Accessories
D

Technical
E

Caterpillar style fittings conform to the bolt hole patterns of SAE Code 62 and require special flange halves and seals. The Caterpillar style flange heads are thicker than SAE Code 62 and measure to a .560" thickness in all sizes.

See Accessories for O-Rings and Flange kits.



1 F78

Caterpillar Flange Head - 45 Elbow

# Part Number	Flange inch	Hose I.D. inch	A		E		F inch	B	
			inch	mm	inch	mm		inch	mm
1XF78-12-12	3/4	3/4	4.82	122	1.21	31	1-5/8	3.06	78
1XF78-16-12	1	3/4	4.81	120	1.20	30	1-7/8	3.05	77
1XF78-16-16	1	1	5.46	139	1.43	36	1-7/8	3.61	92
1XF78-20-16	1-1/4	1	5.46	139	1.43	36	2-1/8	3.61	92
1XF78-20-20	1-1/4	1-1/4	6.38	162	1.44	37	2-1/8	3.99	101
1XF78-24-20	1-1/2	1-1/4	6.38	162	1.44	37	2-1/2	3.99	101
1XF78-24-24	1-1/2	1-1/2	6.89	175	1.54	39	2-1/2	4.68	119

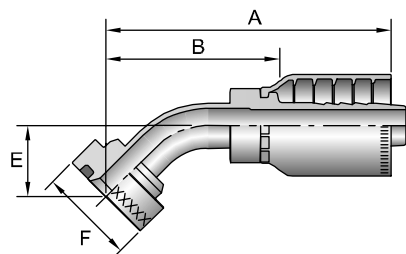

1 78

Caterpillar Flange Head - 60 Elbow

# Part Number	Flange inch	Hose I.D. inch	A		E		F inch	B	
			inch	mm	inch	mm		inch	mm
1X 78-16-16	1	1	5.13	130	1.96	50	1-7/8	3.28	83
1X 78-20-20	1-1/4	1-1/4	6.72	171	2.02	51	2-1/8	4.33	110
1X 78-24-24	1-1/2	1-1/2	6.87	174	2.04	52	2-1/2	4.67	119

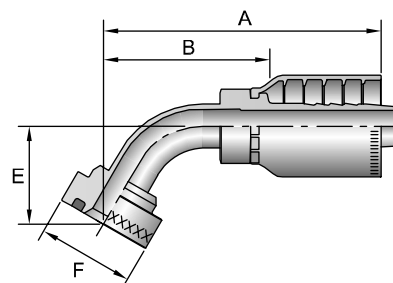

1 N78

Caterpillar Flange Head - 90 Elbow

# Part Number	Flange inch	Hose I.D. inch	A		E		F inch	B	
			inch	mm	inch	mm		inch	mm
1XN78-12-12	3/4	3/4	4.35	110	2.46	62	1-5/8	2.59	66
1XN78-12-16	3/4	1	4.58	116	2.46	62	1-5/8	2.73	69
1XN78-16-12	1	3/4	4.35	110	2.44	62	1-7/8	2.59	66
1XN78-16-16	1	1	5.04	128	2.90	74	1-7/8	3.19	81
1XN78-20-16	1-1/4	1	5.04	128	2.90	74	2-1/8	3.19	81
1XN78-20-20	1-1/4	1-1/4	6.75	171	3.02	77	2-1/8	4.36	111
1XN78-24-20	1-1/2	1-1/4	6.75	171	3.02	77	2-1/2	4.36	111
1XN78-24-24	1-1/2	1-1/2	5.85	149	3.41	87	2-1/2	3.64	92

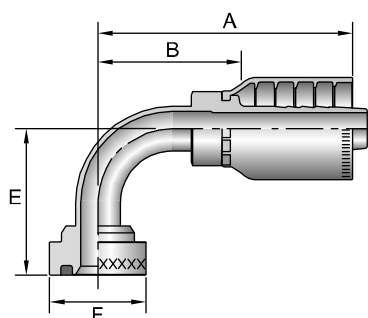

Caterpillar style fittings conform to the bolt hole patterns of SAE Code 62 and require special flange halves and seals. The Caterpillar style flange heads are thicker than SAE Code 62 and measure to a .560" thickness in all sizes.

See Accessories for O-Rings and Flange kits.



Hose
A

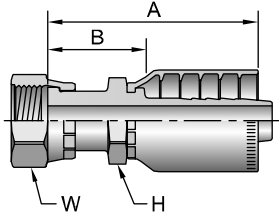

1JS78

Female Seal-Lok - Swivel - Long
ISO 12151-1 - SWSB

# Part Number	Thread		Hose I.D. inch	A		H		B	
	inch	inch		inch	mm	inch	inch	inch	mm
1JS78-12-12	3/4	1-3/16x12	3/4	3.70	94	1-1/8	1-3/8	1.94	49
1JS78-16-16	1	1-7/16x12	1	4.03	102	1-3/8	1-5/8	2.18	55
1JS78-20-16	1-1/4	1-11/16x12	1	3.99	101	1-3/4	1-7/8	2.14	54
1JS78-20-20	1-1/4	1-11/16x12	1-1/4	4.62	117	1-3/4	1-7/8	2.23	57
1JS78-24-24	1-1/2	2-12	1-1/2	4.70	119,4	2	2-1/4	2.49	63,2

Fittings
78 Series
B

1J778

Female Seal-Lok - Swivel - 45 Elbow
ISO 12151-1 - SWE45

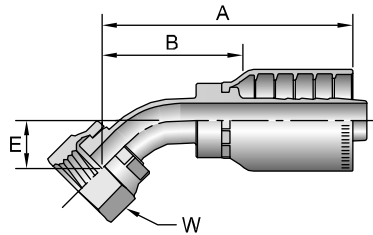

# Part Number	Thread		Hose I.D. inch	A		E		inch	B	
	inch	inch		inch	mm	inch	mm		inch	mm
1J778-12-12	3/4	1-3/16x12	3/4	4.11	104	0.81	21	1-3/8	2.35	60
1J778-16-16	1	1-7/16x12	1	4.69	119	0.94	24	1-5/8	2.84	72
1J778-20-20	1-1/4	1-11/16x12	1-1/4	5.78	147	0.98	25	1-7/8	3.29	84
1J778-24-24	1-1/2	2x12	1-1/2	6.91	176	1.56	40	2-1/4	4.70	119

Equipment
C

1J 78

Female Seal-Lok - Swivel - 0 Elbow - Short Drop
ISO 12151-1 - SWES90

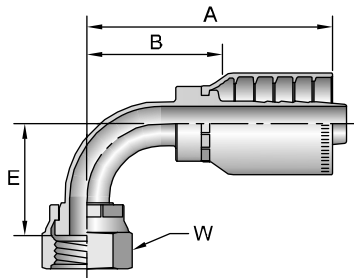

# Part Number	Thread		Hose I.D. inch	A		E		inch	B	
	inch	inch		inch	mm	inch	mm		inch	mm
1J978-12-12	3/4	1-3/16x12	3/4	3.97	100	1.89	48	1-3/8	2.21	56
1J978-16-16	1	1-7/16x12	1	4.62	117	2.21	56	1-5/8	2.77	70
1J978-20-16	1-1/4	1-11/16x12	1	5.04	128	2.54	65	1-7/8	3.10	81
1J978-20-20	1-1/4	1-11/16x12	1-1/4	5.82	148	2.52	64	1-7/8	3.43	87
1J978-24-24	1-1/2	2x12	1-1/2	6.58	167	2.70	69	2-1/4	4.37	111

Accessories
D

Technical
E

See Accessories for O-Rings and Flange its.



1D278

Male Metric S - Rigid - (24 Cone)

# Part Number	Thread		Hose I.D. inch	A		H		B	
	mm	M		inch	mm	mm	inch	mm	
1D278-25-12	25	M36x2	3/4	3.38	86	36	1.62	41	
1D278-30-16	30	M42x2	1	3.72	94	46	1.87	47	
1D278-38-20	38	M52x2	1-1/4	4.42	112	55	2.03	52	

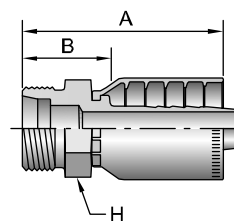

1C 78

Female Metric S - Swivel - (24 Cone with -Ring)

# Part Number	Thread		Hose I.D. inch	A		C		B		
	mm	M		inch	mm	inch	mm	inch	mm	
1C978-25-12	25	M36x2	3/4	3.12	79	0.10	3	46	1.36	35
1C978-30-16	30	M42x2	1	3.40	86	0.19	5	50	1.55	39
1C978-38-20	38	M52x2	1-1/4	3.98	101	0.23	6	60	1.59	40

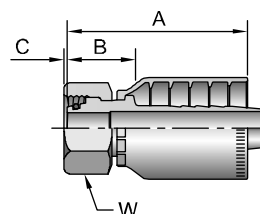

When measuring overall length to the end of the nut, B C dimensions must be used to calculate cut-off allowance.

10C78

Female Metric S - Swivel - 45 Elbow - (24 Cone with -Ring)
 ISO 12151-2 - SWE45 - S

# Part Number	Thread		Hose I.D. inch	A		E		B		
	mm	M		inch	mm	inch	mm	inch	mm	
10C78-25-12	25	M36x2	3/4	4.45	113	1.14	29	46	2.56	65
10C78-30-16	30	M42x2	1	5.16	131	1.34	34	50	3.19	81
10C78-38-20	38	M52x2	1-1/4	6.44	164	1.50	38	60	4.05	103

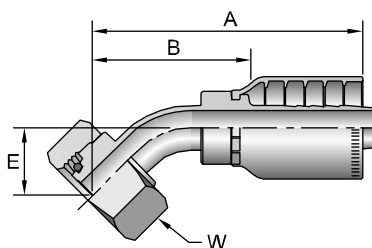

11C78

Female Metric S - Swivel - 90 Elbow - (24 Cone with -Ring)
 ISO 12151-2 - SWE - S

# Part Number	Thread		Hose I.D. inch	A		E		B		
	mm	M		inch	mm	inch	mm	inch	mm	
11C78-25-12	25	M36x2	3/4	4.12	105	2.32	59	46	2.36	60
11C78-30-16	30	M42x2	1	4.71	120	2.68	68	50	2.86	73
11C78-38-20	38	M52x2	1-1/4	5.67	144	2.86	73	60	3.28	83

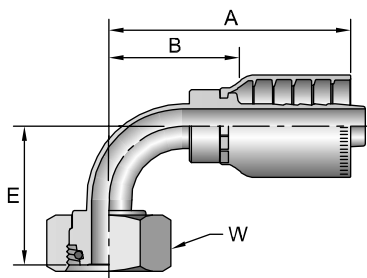

1 78

Female BSP Parallel Pipe - Swivel - (60 Cone)

# Part Number	Thread		Hose I.D. inch	A		H		B	
	inch	inch		inch	mm	mm	mm	inch	mm
1 U78-12-12	3/4x14	3/4	3/4	3.76	96	36	36	2.00	51
1 U78-16-16	1x11	1	1	4.14	105	41	41	2.29	58

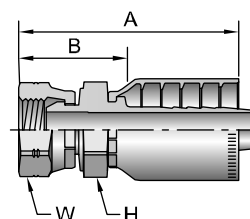

Metric S: Mates with EO "S" Series Fittings. See Accessories for O-Rings and Flange Kits.



Hose
A

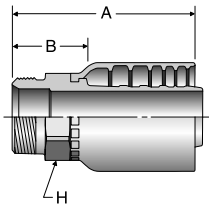

101S6

Male NPTF Pipe - Rigid

#	Thread	Hose I.D.	A		H	B	
			inch	mm		inch	mm
101S6-32-32	2 x 11 1/2	2	5.88	149,5	2-1/2	2.44	61,9

Fittings
7/8 Series
B

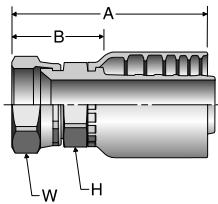

106S6

Female JIC 37° - Swivel

#	Thread	Hose I.D.	A		H	B	
			inch	mm		inch	mm
106S6-32-32	2 1/2 x 12	2	6.52	165,7	2.5	3.08	78,2

Equipment
C

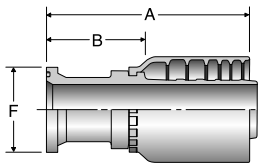

14AS6

SAE Code 61 Flange Head - 5 000 psi
ISO 12151-3-S-L (5,000 psi)

#	Flange	Hose I.D.	A		F	B		E	
			inch	mm		inch	mm	inch	mm
14AS6-32-32	2	2	6.72	170,8	2-13/16	3.28	83,3	-	-

Accessories
D

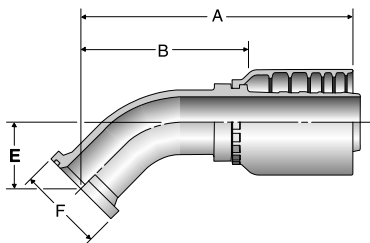

14FS6

SAE Code 61 Flange Head - 45° Elbow - 5 000 psi
ISO 12151-3-E-45S-L (1 Piece: ISO 12151-3-E45M-L) (5,000 psi)

#	Flange	Hose I.D.	A		F	B		E	
			inch	mm		inch	mm	inch	mm
14FS6-32-32	2	2	9.00	228,7	2-13/16	5.56	141,2	2.205	56,0

Technical
E

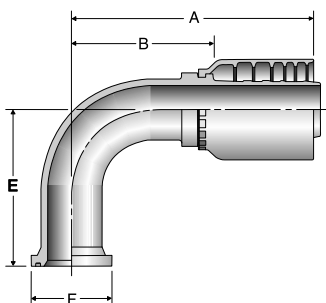



14NS6

SAE Code 61 Flange Head - 90° Elbow - 5 000 psi
ISO 12151-3-E-90S-L (1 Piece: ISO 12151-3-E90M-L) (5,000 psi)

#	Flange	Hose I.D.	A		F	B		E	
			inch	mm		inch	mm	inch	mm
14NS6-32-32	2	2	8.41	213,7	2-13/16	4.97	126,2	5.433	138,0

16AS6

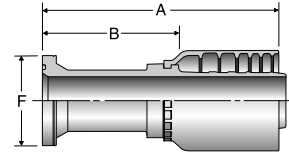

SAE Code 62 Flange Head
ISO 12151-3-S-S

#			A		F		B		E	
			inch	mm	inch	inch	mm	inch	mm	
16AS6-32-32	2	2	8.21	208,6	3-1/8	4.77	121,1	-	-	



16FS6

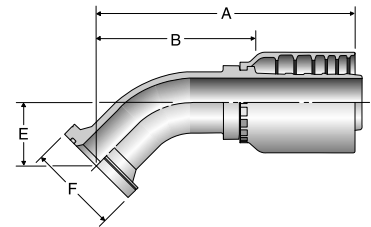

SAE Code 62 Flange Head - 45 Elbow
ISO 12151-3-E45S-S (1 Piece: ISO 1251-3-E45-M-S)

#			A		F		B		E	
			inch	mm	inch	inch	mm	inch	mm	
16FS6-32-32	2	2	9.00	208,6	3-1/8	5.56	141,2	2.205	56,0	



16NS6

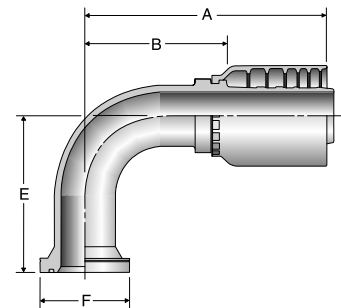

SAE Code 62 Flange Head - 90 Elbow
ISO 12151-3-E90S-S (1 Piece: ISO 1251-3-E90M-S)

#			A		F		B		E	
			inch	mm	inch	inch	mm	inch	mm	
16NS6-32-32	2	2	8.41	213,7	3-1/8	4.97	126,2	5.43	138,0	



1 AS6

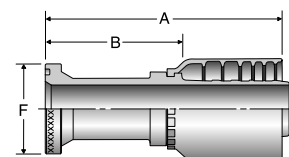

Caterpillar Flange Head

#			A		F		B	
			inch	mm	inch	inch	mm	
IXAS6-32-32	2	2	8.21	208,6	3-1/8	4.77	121	



1JSS6

SAE Code 61 Flange Head - Straight
ISO 12151-S-L

#			A		H		B	
			inch	mm	inch	inch	mm	
1JSS6-32-32	2	2.5X12	6.46	164,2	2.5	3.02	76,7	

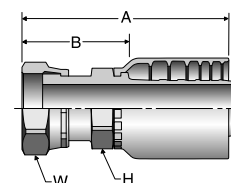

Hose

A

Fittings
78 Series

B

Equipment

C

Accessories

D

Technical

E

Hose
A





Fittings
78 Series
B

Equipment
C

Accessories
D

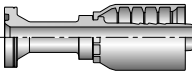
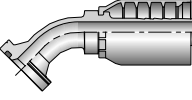
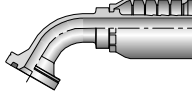
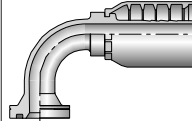
Technical
E

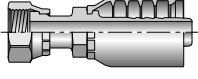
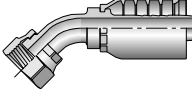
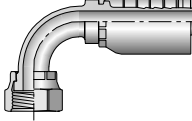

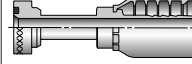
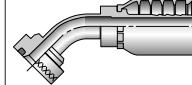
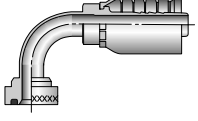
 <p>Cone Flange</p>	<p>16A79 B-106</p>  <p>lange</p>	<p>16F79 B-106</p>  <p>lbow</p>	<p>16 79 B-106</p>  <p>lbow</p>	<p>16N79 B-107</p>  <p>lbow</p>	 <p>Sealing Face Seal</p>
<p>1JS79 B-107</p>  <p>emale Swivel ong</p>	<p>1J779 B-107</p>  <p>emale Swivel lbow</p>	<p>1J979 B-107</p>  <p>emale Swivel lbow Short</p>	 <p>Flange ea</p>	<p>1XA79 B-108</p>  <p>lange Head</p>	<p>1XF79 B-108</p>  <p>lbow</p>
<p>1XN79 B-108</p>  <p>lbow</p>					

Hose	A
Fittings 7 Series	B
Equipment	C
Accessories	D
Technical	E

Hose
A

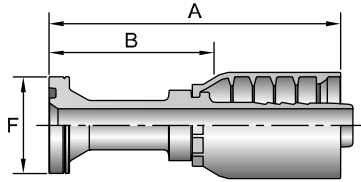

16A7

SAE Code 62 Flange Head
ISO 12151-3 - S - S

# Part Number	Flange inch	Hose I.D. inch	A		F		B	
			inch	mm	inch	inch	inch	mm
16A79-12-12	3/4	3/4	4.90	124	1-5/8	2.84	72	
16A79-16-12	1	3/4	3.88	99	1-7/8	1.82	46	
16A79-16-16	1	1	5.48	139	1-7/8	3.31	84	
16A79-20-16	1-1/4	1	4.28	109	2-1/8	2.11	54	
16A79-20-20	1-1/4	1-1/4	6.09	155	2-1/8	3.41	87	
16A79-24-24	1-1/2	1-1/2	7.11	181	1-1/2	4.07	103	

Fittings
7 Series
B

16F7

SAE Code 62 Flange Head - 45 Elbow
ISO 12151-3 - E45S - S (1 Piece: ISO 12151-3 - E45M - S)

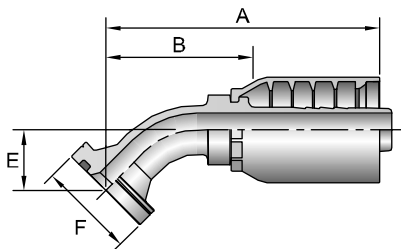

# Part Number	Flange inch	Hose I.D. inch	A		E		F		B	
			inch	mm	inch	mm	inch	inch	inch	mm
16F79-12-12	3/4	3/4	4.61	117	1.02	26	1-5/8	2.55	65	
16F79-16-16	1	1	5.33	135	1.26	32	1-7/8	3.16	80	
16F79-16-20	1	1-1/4	6.25	159	1.50	38	1-7/8	3.57	91	
16F79-20-16	1-1/4	1	5.33	135	1.26	32	2-1/8	3.16	80	
16F79-20-20	1-1/4	1-1/4	6.77	172	1.50	38	2-1/8	4.09	104	
16F79-24-24	1-1/2	1-1/2	7.96	202	1.73	44	2-1/2	4.07	103	

Equipment
C

16 7

SAE Code 62 Flange Head - 60 Elbow
ISO 12151-3 - E60S - S (1 Piece: ISO 12151-3 - E60M - S)

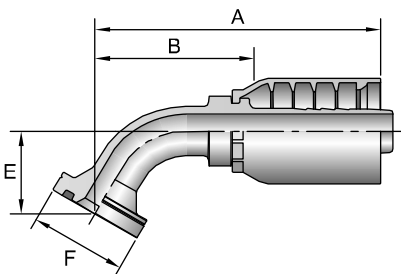

# Part Number	Flange inch	Hose I.D. inch	A		E		F		B	
			inch	mm	inch	mm	inch	inch	inch	mm
16 79-16-16	1	1	6.18	157	1.73	44	1-7/8	4.01	102	

Accessories
D

Technical
E

See Accessories for O-Rings and Flange fits.



16N7

SAE Code 62 Flange Head - 0 Elbow
ISO 12151-3 - E90S - S (1 Piece: ISO 12151-3 - E90M - S)

# Part Number	Flange inch	Hose I.D. inch	A		E		F		B	
			inch	mm	inch	mm	inch	mm	inch	mm
16N79-12-12	3/4	3/4	4.27	108	2.28	58	1-5/8	2.21	56	
16N79-16-12	1	3/4	4.27	108	2.28	58	1-7/8	2.21	56	
16N79-16-16	1	1	4.95	126	2.76	70	1-7/8	2.78	71	
16N79-20-16	1-1/4	1	4.95	126	2.76	70	2-1/8	2.78	71	
16N79-20-20	1-1/4	1-1/4	6.31	160	3.54	90	2-1/8	3.63	92	
16N79-24-24	1-1/2	1-1/2	7.50	190	4.09	104	2-1/2	4.46	113	

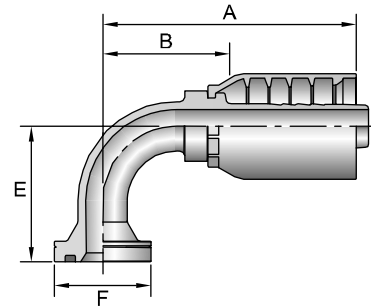

1JS7

Female Seal-Lok - Swivel - Long
ISO 12151-1 - SWSB

# Part Number	Thread inch		Hose I.D. inch	A		H		B	
	inch	mm		inch	mm	inch	mm	inch	mm
1JS79-12-12	3/4	1-3/16x12	3/4	3.99	101	1-1/8	1-3/8	1.93	49
1JS79-16-12	1	1-7/16x12	3/4	4.26	108	1-3/8	1-5/8	2.20	56
1JS79-16-16	1	1-7/16x12	1	4.45	113	1-3/8	1-5/8	2.28	58
1JS79-20-16	1-1/4	1-11/16x12	1	4.32	110	1-3/4	1-7/8	2.15	55
1JS79-20-20	1-1/4	1-11/16x12	1-1/4	5.00	127	1-3/4	1-7/8	2.32	59
1JS79-24-24	1-1/2	2x12	1-1/2	5.28	134	2	2-1/4	2.24	57

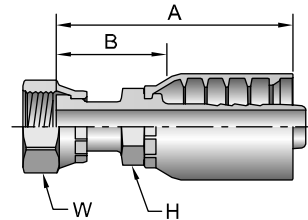

1J77

Female Seal-Lok - Swivel - 45 Elbow
ISO 12151-1 - SWE45

# Part Number	Thread inch		Hose I.D. inch	A		E		B	
	inch	mm		inch	mm	inch	mm	inch	mm
1J779-12-12	3/4	1-3/16x12	3/4	4.40	112	0.83	21	1-3/8	2.34
1J779-16-16	1	1-7/16x12	1	5.01	127	0.94	24	1-5/8	2.84
1J779-20-20	1-1/4	1-11/16x12	1-1/4	6.15	156	1.00	25	1-7/8	3.49

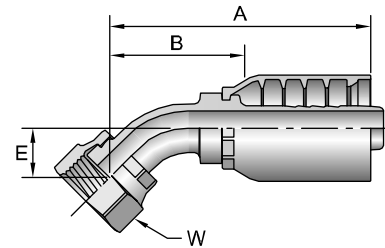

1J 7

Female Seal-Lok - Swivel - 0 Elbow - Short Drop
ISO - 12151-1 - SWES90

# Part Number	Thread inch		Hose I.D. inch	A		E		B	
	inch	mm		inch	mm	inch	mm	inch	mm
1J979-12-12	3/4	1-3/16x12	3/4	4.27	108	1.88	48	1-3/8	2.21
1J979-16-16	1	1-7/16x12	1	4.95	126	2.21	56	1-5/8	2.78
1J979-20-20	1-1/4	1-11/16x12	1-1/4	6.20	157	2.52	64	1-7/8	3.52

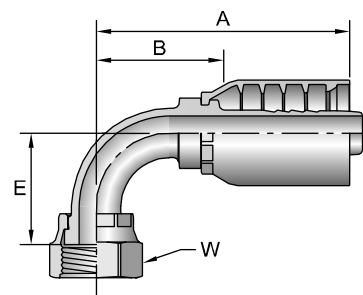

See Accessories for O-Rings and Flange kits.

Hose
A
Fittings
B
Equipment
C
Accessories
D
Technical
E

Hose
A

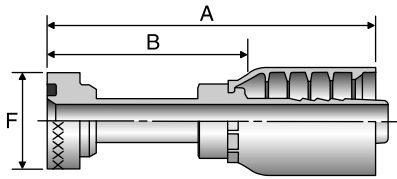

1 A7 Caterpillar Flange Head

# Part Number	Flange inch	Hose I.D. inch	A		F		B	
			inch	mm	inch	inch	inch	mm
1XA79-12-12	3/4	3/4	4.89	124	1-5/8	2.83	72	
1XA79-16-16	1	1	5.75	146	1-7/8	3.59	91	
1XA79-20-16	1-1/4	1	4.32	110	2-1/8	2.15	55	
1XA79-20-20	1-1/4	1-1/4	6.25	159	2-1/8	3.57	91	
1XA79-24-24	1-1/2	1-1/2	7.17	182	2-1/2	4.13	105	

Fittings
7 Series
B

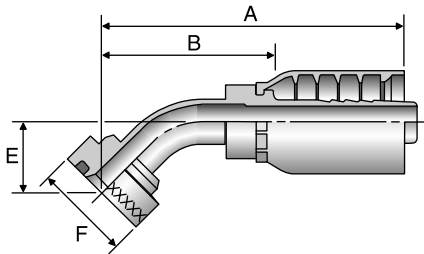

1 F7 Caterpillar Flange Head - 45 Elbow

# Part Number	Flange inch	Hose I.D. inch	A		E		F		B	
			inch	mm	inch	mm	inch	inch	inch	mm
1XF79-12-12	3/4	3/4	4.80	122	1.22	31	1-5/8	2.74	70	
1XF79-16-16	1	1	5.49	139	1.42	36	1-7/8	3.32	84	
1XF79-20-16	1-1/4	1	5.49	139	1.42	36	2-1/8	3.32	84	
1XF79-20-20	1-1/4	1-1/4	6.72	171	1.44	37	2-1/8	4.04	103	

Equipment
C

1 N7 Caterpillar Flange Head - 0 Elbow

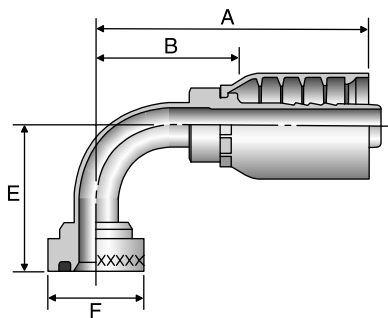

# Part Number	Flange inch	Hose I.D. inch	A		E		F		B	
			inch	mm	inch	mm	inch	inch	inch	mm
1XN79-12-12	3/4	3/4	4.27	108	2.48	63	1-5/8	2.21	56	
1XN79-16-16	1	1	4.94	125	2.91	74	1-7/8	2.78	71	
1XN79-20-16	1-1/4	1	4.94	125	2.91	74	2-1/8	2.78	71	
1XN79-20-20	1-1/4	1-1/4	6.31	160	3.70	94	2-1/8	3.63	92	
1XN79-24-24	1-1/2	1-1/2	7.50	191	4.16	106	2-1/2	4.46	113	

Accessories
D

Technical
E

Hose
A

Fittings
7 Series
B

Equipment
C

Accessories
D

Technical
E



Hose
A

Fittings
H Series
B

Equipment
C

Accessories
D

Technical
E

	101HY B-111 Male Rigid	113HY B-111 Male Swivel	11LHY B-112 Male Swivel elbow	102HY B-112 Female Rigid	
107HY B-112 Female Swivel Cone		105HY B-113 Male Rigid	10 HY B-113 Male Swivel	10LHY B-114 Swivel Swivel elbow	
103HY B-114 Male Rigid	106HY B-115 Female Swivel	137HY B-116 Female Swivel elbow Short	139HY B-116 Female Swivel elbow Short	141HY B-117 Female Swivel elbow Long	193HY B-117 Female Swivel elbow Loc
	108HY B-117 Female Swivel	177HY B-118 Female Swivel elbow	179HY B-118 Female Swivel elbow		111HY B-118 Male Rigid
	1 JHY B-118 Female Rigid		134HY B-119 Male Standpipe Rigid		128HY B-119 Male Swivel
167HY B-119 Male Swivel elbow	169HY B-120 Male Swivel elbow	129HY B-120 Female Rigid		1J0HY B-120 Male Rigid w/ Ring	1JCHY B-120 Female Swivel Short
1JSHY B-121 Female Swivel Long	1J7HY B-121 Female Swivel elbow	1J9HY B-122 Female Swivel elbow Short	1J1HY B-122 Female Swivel elbow Long		1D0HY B-123 Male Rigid
13DHY B-123 Male Standpipe Rigid		1D9HY B-123 Male Rigid	1 UHY B-124 Female Swivel	1UTHY B-124 Male Rigid	1XUHY B-124 Female Metric Swivel



101H

Male NPTF Pipe - Rigid

# Part Number	Thread inch	Hose I.D. inch	A		H inch	B		Additional Material Stainless Steel (C303)
			inch	mm		inch	mm	
101HY-2-4	1/8x27	1/4	2.34	59	5/8	1.00	25	
101HY-4-4	1/4x18	1/4	2.53	64	9/16	1.19	30	
101HY-4-5	1/4x18	5/16	2.56	65	11/16	1.22	31	
101HY-4-6	1/4x18	3/8	2.55	65	11/16	1.19	30	
101HY-6-4	3/8x18	1/4	2.53	64	3/4	1.19	30	
101HY-6-5	3/8x18	5/16	2.56	65	3/4	1.22	31	
101HY-6-6	3/8x18	3/8	2.55	65	3/4	1.19	30	
101HY-6-8	3/8x18	1/2	2.72	69	7/8	1.38	35	
101HY-8-4	1/2x14	1/4	2.72	69	7/8	1.38	35	
101HY-8-6	1/2x14	3/8	2.73	69	7/8	1.38	35	
101HY-8-7	1/2x14	13/32	2.73	69	7/8	1.38	35	
101HY-8-8	1/2x14	1/2	2.91	74	7/8	1.41	40	
101HY-8-10	1/2x14	5/8	2.94	75	1-1/8	1.59	40	
101HY-8-12	1/2x14	3/4	3.08	78	1-1/4	1.50	38	
101HY-12-8	3/4x14	1/2	2.91	74	1-1/16	1.56	40	
101HY-12-10	3/4x14	5/8	2.98	76	1-1/8	1.59	40	
101HY-12-12	3/4x14	3/4	3.08	78	1-1/4	1.50	38	
101HY-12-16	3/4x14	1	3.23	82	1-3/8	1.63	41	
101HY-16-12	1x11-1/2	3/4	3.27	83	1-3/8	1.69	43	
101HY-16-14	1x11-1/2	7/8	3.27	83	1-3/8	1.78	43	
101HY-16-16	1x11-1/2	1	3.42	87	1-3/8	1.81	46	
101HY-20-20	1-1/4x11-1/2	1-1/4	3.84	98	1-3/4	2.00	51	

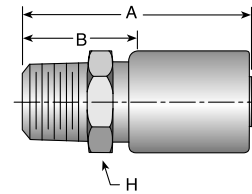

Stainless steel fittings must be assembled with arraykrimp 2, Phastkrimp, Superkrimp or Parkrimp 2. See CrimpSource for more information.

113H

Male NPTF Pipe - Swivel

# Part Number	Thread inch	Hose I.D. inch	A		H inch	H inch	B	
			inch	mm			inch	mm
113HY-2-4	1/8x27	1/4	2.97	75	9/16	5/8	1.63	41
113HY-4-4	1/4x18	1/4	3.06	78	9/16	5/8	1.72	44
113HY-4-6	1/4x18	3/8	3.17	81	11/16	11/16	1.81	46
113HY-6-4	3/8x18	1/4	3.13	80	5/8	11/16	1.78	45
113HY-6-6	3/8x18	3/8	3.11	79	11/16	11/16	1.75	44
113HY-6-8	3/8x18	1/2	3.31	84	7/8	7/8	1.97	50
113HY-8-6	1/2x14	3/8	3.38	86	7/8	7/8	2.03	52
113HY-8-8	1/2x14	1/2	3.50	89	7/8	7/8	2.16	55
113HY-12-12	3/4x14	3/4	3.95	100	1-1/4	1-1/4	2.38	60
113HY-16-16	1x11-1/2	1	4.23	107	1-1/2	1-1/2	2.63	67

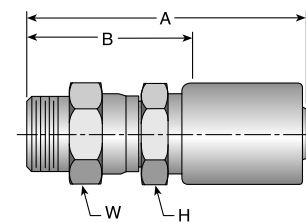

Fitting allows minor movement under pressure to relieve stress on hose but is not to be used for continuous swiveling. See Technical Section for Pressure Limitations.

Hose
A

Fittings
H Series
B

Equipment
C

Accessories
D

Technical
E

Hose
A

Fittings
H Series
B

Equipment
C

Accessories
D

Technical
E

11LH

Male NPTF Pipe - Swivel - 0 Elbow

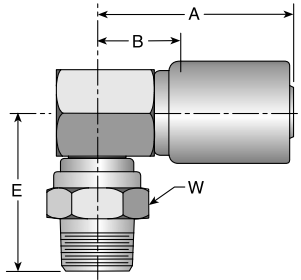

# Part Number	Thread inch	Hose I.D. inch	A		E		B		
			inch	mm	inch	mm	inch	mm	
11LHY-2-4	1/8x27	1/4	2.31	59	1.50	38	5/8	0.97	25
11LHY-4-4	1/4x18	1/4	2.31	59	1.69	43	11/16	0.97	25
11LHY-4-6	1/4x18	3/8	2.33	59	1.69	43	11/16	0.97	25
11LHY-6-4	3/8x18	1/4	2.31	59	1.63	41	11/16	0.97	25
11LHY-6-6	3/8x8	3/8	2.33	59	1.63	41	11/16	0.97	25
11LHY-8-6	1/2x14	3/8	2.73	69	1.88	48	7/8	0.97	25
11LHY-8-8	1/2x14	1/2	3.00	76	1.93	49	7/8	1.09	28

102H

Female NPTF Pipe - Rigid

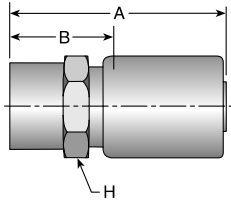

# Part Number	Thread inch	Hose I.D. inch	A		H	B	
			inch	mm	inch	inch	mm
102HY-2-4	1/8x27	1/4	2.34	59	5/8	1.00	25
102HY-4-4	1/4x18	1/4	2.47	63	11/16	1.13	29
102HY-4-6	1/4x18	3/8	2.48	63	11/16	1.13	29
102HY-6-4	3/8x18	1/4	2.47	63	7/8	1.13	29
102HY-6-6	3/8x18	3/8	2.48	63	7/8	1.13	29
102HY-8-6	1/2x14	3/8	2.75	70	1	1.41	36
102HY-8-8	1/2x14	1/2	2.84	72	1	1.50	38
102HY-12-12	3/4x14	3/4	2.83	72	1-1/4	1.25	32
102HY-16-16	1x11-1/2	1	3.27	83	1-1/2	1.66	42

107H

Female NPSM Pipe - Swivel - (60 Cone)

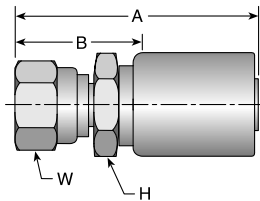

# Part Number	Thread inch	Hose I.D. inch	A		H		B	
			inch	mm	inch	inch	inch	mm
107HY-4-4	1/4x18	1/4	2.66	68	9/16	11/16	1.31	33
107HY-6-4	3/8x18	1/4	2.72	69	3/4	7/8	1.38	35
107HY-6-6	3/8x18	3/8	2.55	65	3/4	7/8	1.19	30
107HY-8-8	1/2x14	1/2	2.91	74	1	1	1.56	40
107HY-12-8	3/4x14	1/2	3.05	77	1-1/4	1-1/4	1.69	43
107HY-12-12	3/4x14	3/4	3.22	82	1-1/4	1-1/4	1.66	42
107HY-16-16	1x11-1/2	1	3.39	86	1-3/8	1-1/2	1.78	45

105H

Male SAE Straight Thread with -Ring - Rigid

# Part Number	Thread inch	Hose I.D. inch	A		H		B	
			inch	mm	inch	inch	inch	mm
105HY-4-4	7/16x20	1/4	2.33	59	9/16	0.97	25	
105HY-5-4	1/2x20	1/4	2.33	59	5/8	0.97	25	
105HY-6-4	9/16x18	1/4	2.42	61	11/16	1.06	27	
105HY-6-6	9/16x18	3/8	2.38	60	11/16	1.03	26	
105HY-8-6	3/4x16	3/8	2.42	61	7/8	1.06	27	
105HY-8-8	3/4x16	1/2	2.59	66	7/8	1.25	32	
105HY-10-6	7/8x14	3/8	2.55	65	1	1.19	30	
105HY-10-8	7/8x14	1/2	2.66	68	1	1.31	33	
105HY-10-10	7/8x14	5/8	2.80	71	1-1/8	1.41	36	
105HY-12-8	1-1/16x12	1/2	2.81	71	1-1/4	1.47	37	
105HY-12-10	1-1/16x12	5/8	2.83	72	1-1/4	1.44	37	
105HY-12-12	1-1/16x12	3/4	2.92	74	1-1/4	1.34	34	
105HY-16-12	1-5/16x12	3/4	2.92	74	1-1/2	1.34	34	
105HY-16-16	1-5/16x12	1	3.08	78	1-1/2	1.47	37	

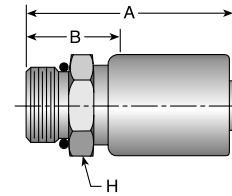

10 H

Male SAE Straight Thread with -Ring - Swivel

# Part Number	Thread inch	Hose I.D. inch	A		H		B	
			inch	mm	inch	inch	inch	mm
10 HY-4-4	7/16x20	1/4	3.00	76	9/16	5/8	1.66	42
10 HY-5-4	1/2x20	1/4	3.00	76	9/16	5/8	1.66	42
10 HY-6-4	9/16x18	1/4	3.16	80	5/8	11/16	1.81	46
10 HY-6-6	9/16x18	3/8	3.14	80	11/16	11/16	1.78	45
10 HY-8-6	3/4x16	3/8	3.24	82	13/16	7/8	1.88	48
10 HY-8-8	3/4x16	1/2	3.36	85	7/8	7/8	2.00	51
10 HY-10-8	7/8x14	1/2	3.44	87	1	1	2.09	53
10 HY-12-8	1-1/16x12	1/2	3.66	93	1-1/4	1-1/4	2.31	59
10 HY-12-12	1-1/16x12	3/4	3.89	99	1-1/4	1-1/4	2.31	59
10 HY-16-16	1-5/16x12	1	3.95	100	1-3/8	1-1/2	2.34	59

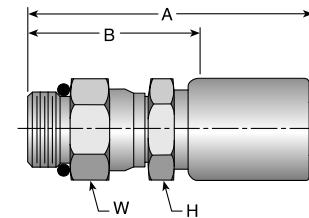

Fitting allows minor movement under pressure to relieve stress on hose but is not to be used on extensive or continuous swiveling.

O-Ring not compatible with Phosphate Ester fluids.



B-

Hose Products Division
Parker Hannifin Corporation
Wickliffe, Ohio
www.parkerhose.com

Hose
A
Fittings H Series
B
Equipment
C
Accessories
D
Technical
E

Hose
A

Fittings
H Series
B

Equipment
C

Accessories
D

Technical
E

10LH

Male SAE Straight Thread with -Ring - Swivel - 0 Elbow

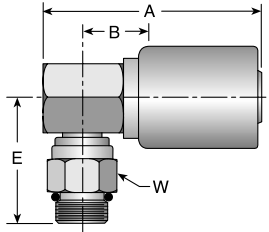

# Part Number	Thread inch	Hose I.D. inch	A		E		B		
			inch	mm	inch	mm	inch	inch	mm
10LHY-4-4	7/16x20	1/4	2.31	59	1.63	41	11/16	0.97	25
10LHY-6-4	9/16x18	1/4	2.31	59	1.66	42	7/8	0.97	25
10LHY-6-6	9/16x18	3/8	2.33	59	1.66	42	11/16	0.97	25
10LHY-8-4	3/4x16	1/4	2.31	59	1.75	44	7/8	0.94	24
10LHY-8-6	3/4x16	3/8	2.33	59	1.73	44	7/8	0.97	25
10LHY-8-8	3/4x16	1/2	3.00	76	1.80	46	7/8	1.09	28
10LHY-10-8	7/8x14	1/2	3.00	76	1.88	48	1	1.09	28
10LHY-12-12	1-1/16x12	3/4	2.77	70	2.23	57	1-1/4	1.19	30

Fitting allows minor movement under pressure to relieve stress on hose but is not to be used on extensive or continuous swiveling.

103H

Male JIC 37 - Rigid

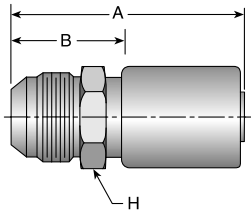

# Part Number	Thread inch	Hose I.D. inch	A		H	B	
			inch	mm	inch	inch	mm
103HY-4-4	7/16x20	1/4	2.52	64	5/8	1.19	30
103HY-5-4	1/2x20	1/4	2.52	64	5/8	1.19	30
103HY-6-4	9/16x18	1/4	2.53	64	11/16	1.19	30
103HY-6-5	9/16x18	5/16	2.56	65	11/16	1.22	31
103HY-6-6	9/16x18	3/8	2.54	65	11/16	1.19	30
103HY-6-8	9/16x18	1/2	2.72	69	7/8	1.38	35
103HY-8-6	3/4x16	3/8	2.64	67	13/16	1.28	33
103HY-8-8	3/4x16	1/2	2.81	71	7/8	1.47	37
103HY-10-6	7/8x14	3/8	2.81	71	1	1.47	37
103HY-10-8	7/8x14	1/2	2.91	74	1	1.56	40
103HY-10-10	7/8x14	5/8	2.98	76	1-1/8	1.59	40
103HY-10-12	7/8x14	3/4	3.08	78	1-1/4	1.50	38
103HY-12-8	1-1/16x12	1/2	3.02	77	1-1/8	1.66	42
103HY-12-10	1-1/16x12	5/8	3.09	78	1-1/8	1.72	44
103HY-12-12	1-1/16x12	3/4	3.19	81	1-1/4	1.63	41
103HY-14-12	1-3/16x12	3/4	3.19	81	1-1/4	1.63	41
103HY-16-12	1-5/16x12	3/4	3.23	82	1-3/8	1.66	42
103HY-16-16	1-5/16x12	1	3.39	86	1-3/8	1.78	45
103HY-20-16	1-5/8x12	1	3.44	87	1-3/4	1.81	46
103HY-20-20	1-5/8x12	1-1/4	3.83	97	1-3/4	2.00	51

106H

Female JIC 37 - Swivel

#	Part Number	Thread inch	Hose I.D. inch	A		H		B		Additional Material Stainless Steel (C303)
				inch	mm	inch	inch	inch	mm	
106HY-3-4		3/8x24	1/4	2.58	66	9/16	1/2	1.22	31	
106HY-4-4		7/16x20	1/4	2.60	66	9/16	9/16	1.25	32	
106HY-4-6		7/16x20	3/8	2.67	68	3/4	9/16	1.31	33	
106HY-5-4		1/2x20	1/4	2.65	67	9/16	5/8	1.31	33	
106HY-5-5		1/2x20	5/16	2.69	68	5/8	5/8	1.34	34	
106HY-5-6		1/2x20	3/8	2.73	69	3/4	5/8	1.38	35	
106HY-6-4		9/16x18	1/4	2.67	68	5/8	11/16	1.31	33	
106HY-6-5		9/16x18	5/16	2.70	69	5/8	11/16	1.34	34	
106HY-6-6		9/16x18	3/8	2.69	68	11/16	11/16	1.34	34	
106HY-8-6		3/4x16	3/8	2.72	69	7/8	7/8	1.38	35	
106HY-8-8		3/4x16	1/2	2.90	74	7/8	7/8	1.41	40	
106HY-8-10		3/4x16	5/8	2.98	76	1-1/8	7/8	1.59	40	
106HY-8-12		3/4x16	3/4	3.08	78	1-1/4	7/8	1.53	39	
106HY-10-6		7/8x14	3/8	2.81	71	7/8	1	1.47	37	
106HY-10-8		7/8x14	1/2	2.98	76	1	1	1.63	41	
106HY-10-10		7/8x14	5/8	3.06	78	1-1/8	1	1.69	43	
106HY-10-12		7/8x14	3/4	3.16	80	1-1/4	1	1.59	40	
106HY-12-6		1-1/16x12	3/8	3.00	76	1-1/8	1-1/4	1.66	42	
106HY-12-8		1-1/16x12	1/2	3.05	77	1-1/8	1-1/4	1.69	43	
106HY-12-10		1-1/16x12	5/8	3.12	79	1-1/8	1-1/4	1.75	44	
106HY-12-12		1-1/16x12	3/4	3.22	82	1-1/4	1-1/4	1.66	42	
106HY-12-16		1-1/16x12	1	3.38	86	1-3/8	1-1/4	1.75	44	
106HY-14-12		1-3/16x12	3/4	3.23	82	1-1/4	1 3/8	1.66	42	
106HY-16-12		1-5/16x12	3/4	3.30	84	1-3/8	1-1/2	1.72	44	
106HY-16-14		1-5/16x12	7/8	3.30	84	1-3/8	1-1/2	1.72	44	
106HY-16-16		1-5/16x12	1	3.45	88	1-3/8	1-1/2	1.84	47	
106HY-16-20		1-5/16x12	1-1/4	3.84	98	1-3/4	1-1/2	2.00	51	
106HY-20-16		1-5/8x12	1	3.70	94	1-3/4	2	2.09	53	
106HY-20-20		1-5/8x12	1-1/4	4.09	104	2	2	2.25	57	

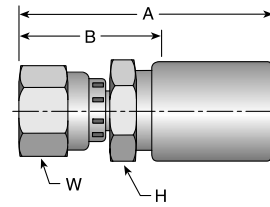

Stainless steel fittings must be assembled with arraykrimp 2, PHastkrimp, Superkrimp or Parkrimp 2. See CrimpSource for more information.

Hose
A

Fittings
H Series
B

Equipment
C

Accessories
D

Technical
E

Hose
A

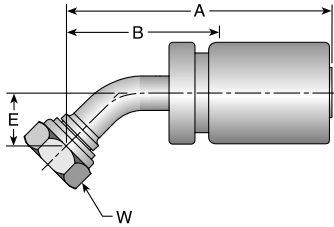

137H

Female JIC 37 - Swivel - 45 Elbow - Short Drop

# Part Number	Thread inch	Hose I.D. inch	A		E		inch	B	
			inch	mm	inch	mm		inch	mm
137HY-4-4	7/16x20	1/4	2.59	66	0.39	10	9/16	1.32	34
137HY-5-4	1/2x20	1/4	3.27	83	0.36	9	5/8	1.91	49
137HY-6-4	9/16x18	1/4	2.70	69	0.43	10	3/4	1.43	36
137HY-6-5	9/16x18	5/16	3.34	85	0.39	11	11/16	2.00	51
137HY-6-6	9/16x18	3/8	2.72	69	0.43	11	11/16	1.44	37
137HY-8-6	3/4x16	3/8	2.88	73	0.58	15	7/8	1.60	41
137HY-8-8	3/4x16	1/2	3.10	79	0.59	15	7/8	1.81	46
137HY-10-8	7/8x14	1/2	3.20	81	0.63	16	1	1.91	49
137HY-10-10	7/8x14	5/8	3.29	84	0.63	16	1	1.93	49
137HY-12-10	1-1/16x12	5/8	3.94	100	0.77	20	1-1/8	2.56	65
137HY-12-12	1-1/16x12	3/4	3.82	97	0.83	21	1-1/4	2.29	58
137HY-16-12	1-5/16x12	3/4	4.35	110	0.89	23	1-1/2	2.78	71
137HY-16-16	1-5/16x12	1	4.31	109	0.89	23	1-1/2	2.69	68

Fittings
H Series
B

13 H

Female JIC 37 - Swivel - 0 Elbow - Short Drop

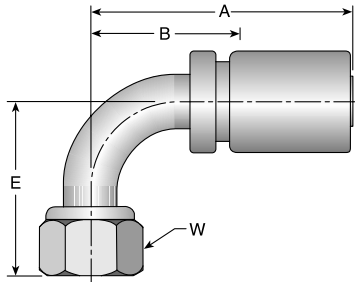

# Part Number	Thread inch	Hose I.D. inch	A		E		inch	B	
			inch	mm	inch	mm		inch	mm
139HY-4-4	7/16x20	1/4	2.40	61	0.83	21	9/16	1.13	29
139HY-5-4	1/2x20	1/4	2.50	64	0.83	21	5/8	1.23	31
139HY-6-4	9/16x18	1/4	2.65	67	0.91	23	3/4	1.38	35
139HY-6-5	9/16x18	5/16	3.25	83	0.86	22	11/16	1.91	49
139HY-6-6	9/16x18	3/8	2.57	65	0.91	23	11/16	1.29	33
139HY-6-8	9/16x18	1/2	3.41	87	0.86	22	11/16	2.06	52
139HY-8-6	3/4x16	3/8	2.64	67	1.14	29	7/8	1.37	35
139HY-8-8	3/4x16	1/2	2.85	72	1.14	29	7/8	1.56	40
139HY-10-8	7/8x14	1/2	3.01	76	1.26	32	1	1.72	44
139HY-10-10	7/8x14	5/8	3.09	78	1.26	32	1	1.73	44
139HY-10-12	7/8x14	3/4	3.25	83	1.23	31	1	1.69	43
139HY-12-8	1-1/16x12	1/2	3.61	92	1.83	46	1-1/4	2.25	57
139HY-12-10	1-1/16x12	5/8	3.61	92	1.89	48	1-1/4	2.25	57
139HY-12-12	1-1/16x12	3/4	3.68	93	1.89	48	1-1/4	2.15	55
139HY-16-12	1-5/16x12	3/4	4.33	110	2.14	54	1-1/2	2.78	71
139HY-16-16	1-5/16x12	1	4.31	109	2.31	59	1-1/2	2.69	68

Equipment
C

Accessories
D

Technical
E

141H

Female JIC 37 - Swivel - 90 Elbow - Long Drop

# Part Number	Thread inch	Hose I.D. inch	A		E		B		
			inch	mm	inch	mm	inch	inch	mm
141HY-4-4	7/16x20	1/4	2.68	68	1.81	46	9/16	1.41	36
141HY-5-4	1/2x20	1/4	3.16	80	1.77	45	5/8	1.81	46
141HY-6-4	9/16x18	1/4	2.89	73	2.13	54	11/16	1.62	41
141HY-6-6	9/16x18	3/8	2.76	70	2.13	54	11/16	1.49	39
141HY-8-6	3/4x16	3/8	2.85	72	2.52	64	7/8	1.58	40
141HY-8-8	3/4x16	1/2	2.89	73	2.52	64	7/8	1.60	41
141HY-10-8	7/8x14	1/2	3.01	76	2.76	70	1	1.72	44
141HY-12-12	1-1/16x12	3/4	3.59	91	3.73	95	1-1/4	2.03	52
141HY-16-16	1-5/16x12	1	4.56	116	4.33	110	1-1/2	2.94	75

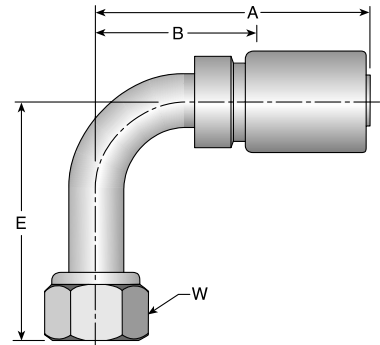

133H

Female JIC 37 - Swivel - 90 Elbow - (Block Type)

# Part Number	Thread inch	Hose I.D. inch	A		E		B		
			inch	mm	inch	mm	inch	inch	mm
193HY-6-6	9/16x18	3/8	2.33	59	0.78	20	11/16	0.97	25
193HY-8-6	3/4x16	3/8	2.33	59	0.82	21	7/8	0.97	25
193HY-8-8	3/4x16	1/2	3.00	76	0.85	22	7/8	1.09	28
193HY-12-12	1-1/16x12	3/4	3.33	85	0.99	25	1-1/4	1.19	30

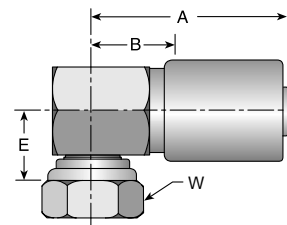

108H

Female SAE 45 - Swivel

# Part Number	Thread inch	Hose I.D. inch	A		H		B		
			inch	mm	inch	inch	inch	inch	mm
108HY-4-4	7/16x20	1/4	2.60	66	9/16	9/16	1.26	32	
108HY-5-4	1/2x20	1/4	2.66	68	9/16	5/8	1.31	33	
108HY-5-5	1/2x20	5/16	2.68	68	5/8	5/8	1.34	34	
108HY-6-4	5/8x18	1/4	2.73	69	11/16	3/4	1.38	35	
108HY-6-5	5/8x18	5/16	2.76	70	5/8	3/4	1.41	36	
108HY-6-6	5/8x18	3/8	2.75	70	11/16	3/4	1.41	36	
108HY-8-6	3/4x16	3/8	2.73	69	13/16	7/8	1.38	35	
108HY-8-8	3/4x16	1/2	2.90	74	7/8	7/8	1.56	40	
108HY-8-12	3/4x16	3/4	3.17	81	1-1/4	7/8	1.59	40	
108HY-10-8	7/8x14	1/2	2.98	76	1	1	1.63	41	
108HY-10-10	7/8x14	5/8	3.06	78	1-1/8	1	1.69	43	
108HY-12-10	1-1/16x12	5/8	3.33	85	1-1/8	1-1/4	1.94	49	
108HY-12-12	1-1/16x12	3/4	3.41	87	1-1/4	1-1/4	1.84	47	

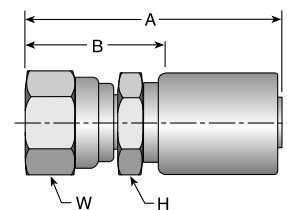

Hose

A

Fittings
H Series

B

Equipment

C

Accessories

D

Technical

E

Hose
A

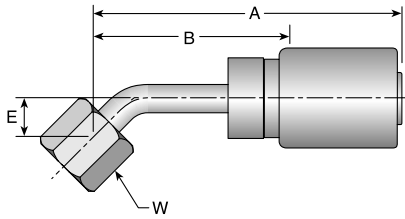

177H
Female SAE 45 - Swivel - 45 Elbow

# Part Number	Thread inch	Hose I.D. inch	A		E		B		
			inch	mm	inch	mm	inch	inch	mm
177HY-6-6	5/8x18	3/8	3.33	85	0.39	10	3/4	1.97	50
177HY-12-12	1-1/16x14	3/4	4.03	102	0.77	20	1-1/4	2.44	62

Fittings
H Series
B

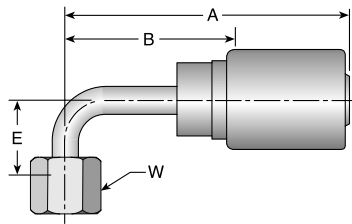

17H
Female SAE 45 - Swivel - 90 Elbow

# Part Number	Thread inch	Hose I.D. inch	A		E		B		
			inch	mm	inch	mm	inch	inch	mm
179HY-6-5	5/8x18	5/16	3.25	83	0.86	22	3/4	1.91	49
179HY-6-6	5/8x18	3/8	3.23	82	0.86	22	3/4	1.88	48
179HY-12-12	1-1/16x14	3/4	3.98	101	1.83	46	1-1/4	2.39	61

Equipment
C

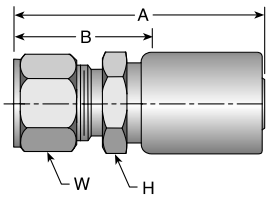

111H
Male Ferulok Flareless - Rigid
(24 Cone w Nut and Ferrule)

# Part Number	Thread inch	Hose I.D. inch	A		H		B	
			inch	mm	inch	inch	inch	mm
111HY-4-4	7/16x20	1/4	2.42	61	9/16	9/16	1.06	27
111HY-4-6	7/16x20	3/8	2.44	62	3/4	9/16	1.09	28
111HY-5-6	1/2x20	3/8	2.44	62	3/4	5/8	1.09	28
111HY-6-4	9/16x18	1/4	2.44	62	5/8	11/16	1.09	28
111HY-6-6	9/16x18	3/8	2.45	62	11/16	11/16	1.09	28
111HY-8-6	3/4x16	3/8	2.61	66	7/8	7/8	1.25	32
111HY-8-8	3/4x16	1/2	2.72	69	7/8	7/8	1.38	35
111HY-10-8	7/8x14	1/2	2.78	71	1	1	1.44	37
111HY-12-12	1-1/16x12	3/4	3.02	77	1-1/4	1-1/4	1.44	37

The Parker Ferrule-Fix fitting makes it possible to salvage the bent tube section from a hose assembly for quick, easy on-the-job repairs. For additional information see Ferrule-Fix installation instructions in the Technical Section.

Accessories
D

Technical
E

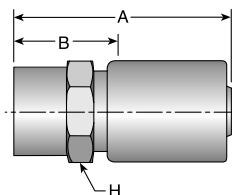

1 JH
Female Ferulok Flareless - Rigid - 1x27
Thread - Rigid - 1/2x27

# Part Number	Thread inch	Hose I.D. inch	A		H		B	
			inch	mm	inch	inch	inch	mm
1 JHY-8-4	1/2x27	1/4	2.41	61	3/4	1.06	27	

134H

Male Standpipe - Rigid - (Inch Size Tube I.D.)

# Part Number	R inch	Hose I.D. inch	A		B	
			inch	mm	inch	mm
134HY-6-6	3/8	3/8	3.17	81	1.81	46
134HY-8-6	1/2	3/8	3.33	85	1.97	50
134HY-12-12	3/4	3/4	3.89	99	2.31	59

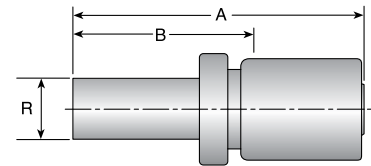

128H

Male Inverted SAE 45 - Swivel

# Part Number	Thread inch	Hose I.D. inch	A		Hex inch	B	
			inch	mm		inch	mm
128HY-3-4	3/8x24	1/4	3.09	78	3/8	1.75	44
128HY-4-4	7/16x24	1/4	3.28	83	7/16	1.94	49
128HY-5-4	1/2x20	1/4	3.34	85	1/2	2.00	51
128HY-5-6	1/2x20	3/8	3.17	81	1/2	1.81	46
128HY-6-5	5/8x18	5/16	3.75	95	5/8	2.41	61
128HY-6-6	5/8x18	3/8	3.73	95	5/8	2.38	60
128HY-7-6	11/16x18	3/8	3.73	95	11/16	2.38	60
128HY-8-6	3/4x18	3/8	3.42	87	3/4	2.06	52
128HY-8-8	3/4x18	1/2	3.66	93	3/4	2.31	59

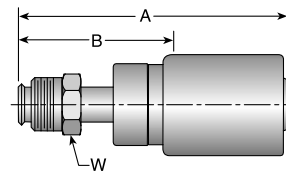

167H

Male Inverted SAE 45 - Swivel - 45 Elbow

# Part Number	Thread inch	Hose I.D. inch	A		E		Hex inch	B	
			inch	mm	inch	mm		inch	mm
167HY-4-4	7/16x24	1/4	3.31	84	0.78	20	7/16	1.97	50
167HY-5-4	1/2x20	1/4	3.55	90	0.88	22	1/2	2.19	56
167HY-5-6	1/2x20	3/8	3.38	86	0.88	22	1/2	2.03	52
167HY-6-6	5/8x18	3/8	4.16	106	0.94	24	5/8	2.81	71
167HY-8-8	3/4x18	1/2	4.22	107	1.06	27	3/4	2.88	73

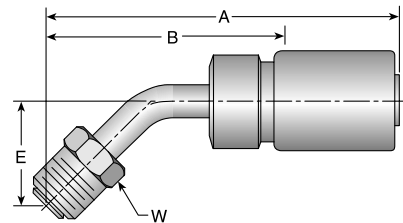

Hose
A

Fittings
H Series
B

Equipment
C

Accessories
D

Technical
E

Hose
A
 Fittings
 H Series
B
 Equipment
C
 Accessories
D
 Technical
E

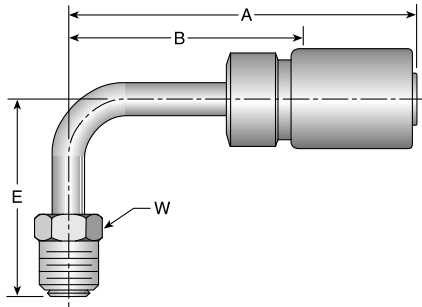

16 H

Male Inverted SAE 45 - Swivel - 0 Elbow

# Part Number	Thread inch	Hose I.D. inch	A		E		B		
			inch	mm	inch	mm	inch	mm	
169HY-3-4	3/8x24	1/4	3.09	78	1.38	35	3/8	1.75	44
169HY-4-4	7/16x24	1/4	3.28	83	1.47	37	7/16	1.94	49
169HY-4-6	7/16x24	3/8	3.11	79	1.47	37	7/16	1.75	44
169HY-5-4	1/2x20	1/4	3.52	89	1.66	42	1/2	2.16	55
169HY-5-6	1/2x20	3/8	3.34	85	1.66	42	1/2	2.00	51
169HY-6-5	5/8x18	5/16	4.05	103	1.69	43	5/8	2.69	68
169HY-6-6	5/8x18	3/8	4.03	102	1.69	43	5/8	2.69	68
169HY-7-6	11/16x18	3/8	4.16	106	1.69	43	11/16	2.81	71
169HY-8-8	3/4x18	1/2	4.09	104	1.88	48	3/4	2.75	70

12 H

Female Inverted SAE 45 - Rigid

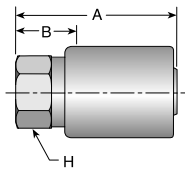

# Part Number	Thread inch	Hose I.D. inch	A		H	B	
			inch	mm	inch	inch	mm
129HY-5-4	1/2x20	1/4	2.25	57	5/8	0.91	23
129HY-6-6	5/8x18	3/8	2.25	57	7/8	0.91	23

1J0H

Male Seal-Lok - Rigid - (with O-Ring)
ISO 1215-1 - S

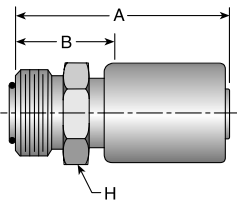

# Part Number	Thread inch	Hose I.D. inch	A		H	B	
			inch	mm	inch	inch	mm
1J0HY-4-4	9/16x18	1/4	2.36	60	5/8	1.00	25
1J0HY-6-6	11/16x16	3/8	2.49	63	3/4	1.13	29
1J0HY-8-8	13/16x16	1/2	2.69	68	7/8	1.34	34
1J0HY-12-8	1-3/16x12	1/2	2.91	74	1-1/4	1.56	40

1JCH

Female Seal-Lok - Swivel - Short
ISO 12151-1 - SWSA

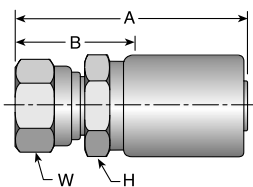

# Part Number	Thread inch	Hose I.D. inch	A		H		B	
			inch	mm	inch	inch	inch	mm
1JCHY-4-4	9/16x18	1/4	2.61	66	9/16	11/16	0.94	24
1JCHY-6-6	11/16x16	3/8	2.69	68	11/16	13/16	0.94	24
1JCHY-8-8	13/16x16	1/2	2.91	74	7/8	15/16	1.13	29
1JCHY-12-12	1-3/16x12	3/4	3.31	84	1-1/4	1-3/8	1.13	29

See Accessories for O-Rings.



1JSH

Female Seal-Lok - Swivel - Long
ISO 12151-1 - SWSB

# Part Number	Thread inch	Hose I.D. inch	A		H		B	
			inch	mm	inch	inch	inch	mm
1JSHY-4-4	9/16x18	1/4	2.59	66	9/16	11/16	1.25	32
1JSHY-6-4	11/16x16	1/4	2.67	68	5/8	13/16	1.31	33
1JSHY-6-5	11/16x16	5/16	2.70	69	5/8	13/16	1.34	34
1JSHY-6-6	11/16x16	3/8	2.75	70	11/16	13/16	1.34	34
1JSHY-8-6	13/16x16	3/8	2.84	72	7/8	15/16	1.50	38
1JSHY-8-8	13/16x16	1/2	2.95	75	7/8	15/16	1.59	40
1JSHY-10-8	1x14	1/2	3.16	80	15/16	1-1/8	1.81	46
1JSHY-10-10	1x14	5/8	3.17	81	1-1/8	1-1/8	1.78	45
1JSHY-10-12	1x14	3/4	3.27	83	1-1/4	1-1/8	1.69	43
1JSHY-12-10	1-3/16x12	5/8	3.20	81	1-1/8	1-3/8	1.81	46
1JSHY-12-12	1-3/16x12	3/4	3.30	84	1-1/4	1-3/8	1.72	44
1JSHY-16-12	1-7/16x12	3/4	3.44	87	1-3/8	1-5/8	1.88	48
1JSHY-16-16	1-7/16x12	1	3.59	91	1-3/8	1-5/8	1.97	50
1JSHY-20-16	1-11/16x12	1	3.47	88	1-5/8	1-7/8	1.75	59
1JSHY-20-20	1-11/16x12	1-1/4	3.98	101	1-3/4	1-7/8	2.16	55

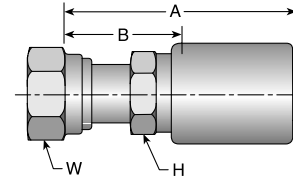

1J7H

Female Seal-Lok - Swivel - 45 Elbow
ISO 12151-1 - SWE45

# Part Number	Thread inch	Hose I.D. inch	A		E		B		
			inch	mm	inch	mm	inch	inch	mm
1J7HY-4-4	9/16x18	1/4	2.59	66	0.39	10	11/16	1.32	34
1J7HY-6-4	11/16x16	1/4	2.70	69	0.43	11	13/16	1.43	36
1J7HY-6-6	11/16x16	3/8	2.72	69	0.43	11	13/16	1.44	37
1J7HY-6-8	11/16x16	1/2	3.41	87	0.44	11	13/16	2.06	52
1J7HY-8-4	13/16x16	1/4	2.95	75	0.59	15	15/16	1.68	43
1J7HY-8-6	13/16x16	3/8	2.89	73	0.59	15	15/16	1.62	41
1J7HY-8-8	13/16x16	1/2	3.10	79	0.59	15	15/16	1.81	46
1J7HY-10-8	1x14	1/2	3.20	81	0.63	16	1-1/8	1.91	49
1J7HY-10-10	1x14	5/8	3.29	84	0.63	16	1-1/8	1.93	49
1J7HY-10-12	1x14	3/4	3.69	94	0.69	18	1-1/8	2.13	54
1J7HY-12-10	1-3/16x12	5/8	3.74	104	0.83	21	1-3/8	2.38	60
1J7HY-12-12	1-3/16x12	3/4	3.82	97	0.83	21	1-3/8	2.29	58
1J7HY-16-12	1-7/16x12	3/4	4.39	112	0.97	25	1-5/8	2.84	72
1J7HY-16-16	1-7/16x12	1	4.55	116	0.97	25	1-5/8	2.94	75

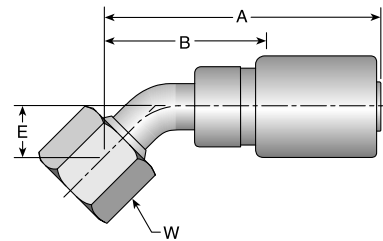

See Accessories for O-Rings.



Hose
A
 Fittings
 H Series
B
 Equipment
C
 Accessories
D
 Technical
E

Hose
A

Fittings
H Series
B

Equipment
C

Accessories
D

Technical
E

1J H

Female Seal-Lok - Swivel - O Elbow - Short Drop
ISO 12151-1 - SWES90

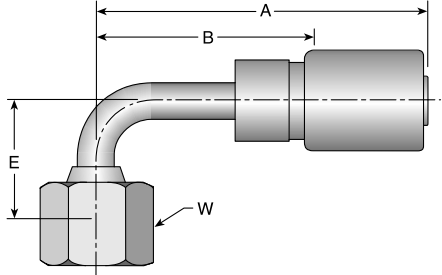

# Part Number	Thread inch	Hose I.D. inch	A		E		B		
			inch	mm	inch	mm	inch	inch	mm
1J9HY-4-4	9/16x18	1/4	2.40	61	0.83	21	11/16	1.13	29
1J9HY-4-6	9/16x18	3/8	3.08	78	0.83	21	11/16	1.72	44
1J9HY-6-4	11/16x16	1/4	2.65	67	0.91	23	13/16	1.38	35
1J9HY-6-5	11/16x16	5/16	3/14	80		23	13/16	1.72	44
1J9HY-6-6	11/16x16	3/8	2.57	65	0.91	23	13/16	1.29	33
1J9HY-6-8	11/16x16	1/2	2.77	70	0.91	23	13/16	1.48	38
1J9HY-8-6	13/16x16	3/8	2.64	67	1.14	29	15/16	1.37	35
1J9HY-8-8	13/16x16	1/2	2.85	72	1.14	29	15/16	1.56	40
1J9HY-10-8	1x14	1/2	3.01	76	1.26	32	1-1/8	1.72	44
1J9HY-10-10	1x14	5/8	3.09	78	1.26	32	1-1/8	1.73	44
1J9HY-10-12	1x14	3/4	3.52	89	1.33	34	1-1/8	1.97	50
1J9HY-12-8	1-3/16x12	1/2	3.84	98	1.89	48	1-3/8	2.39	61
1J9HY-12-10	1-3/16x12	5/8	3.61	92	1.89	48	1-3/8	2.25	57
1J9HY-12-12	1-3/16x12	3/4	3.68	93	1.89	48	1-3/8	2.15	55
1J9HY-16-12	1-7/16x12	3/4	4.27	108	2.25	57	1-5/8	2.69	68
1J9HY-16-16	1-7/16x12	1	4.45	113	2.25	57	1-5/8	2.84	72
1J9HY-20-16	1-11/16x12	1	4.77	121	2.51	64	1-7/8	3.16	80

1J1H

Female Seal-Lok - Swivel - O Elbow - Long Drop
ISO 12151-1 - SWEL90

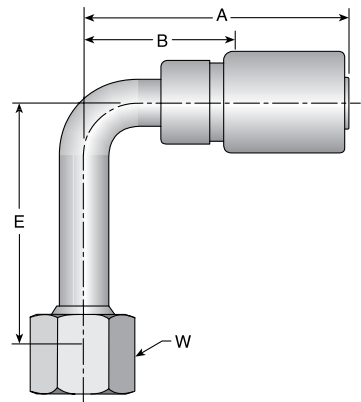

# Part Number	Thread inch	Hose I.D. inch	A		E		B		
			inch	mm	inch	mm	inch	inch	mm
1J1HY-4-4	9/16x18	1/4	2.68	68	1.81	46	11/16	1.41	36
1J1HY-6-4	11/16x16	1/4	2.89	73	2.13	54	13/16	1.62	41
1J1HY-6-6	11/16x16	3/8	2.76	70	2.13	54	13/16	1.49	38
1J1HY-8-6	13/16x16	3/8	2.85	72	2.52	64	15/16	1.58	40
1J1HY-8-8	13/16x16	1/2	2.94	75	2.52	64	15/16	1.65	42
1J1HY-10-8	1x14	1/2	3.01	76	2.76	70	1-1/8	1.72	44
1J1HY-10-10	1x14	5/8	3.42	87	3.83	70	1-1/8	2.03	52
1J1HY-12-12	1-3/16x12	3/4	3.68	93	3.78	96	1-3/8	2.15	55
1J1HY-16-16	1-7/16x12	1	4.45	113	4.50	114	1-5/8	2.84	72

See Accessories for O-Rings.



1D0H

Male Metric L - Rigid - (24 Cone)
ISO 8434-1

# Part Number	Thread		Hose I.D. inch	A		H mm	B	
	mm	M		inch	mm		inch	mm
1D0HY-6-4	6	M12x1.5	1/4	2.36	60	14	1.00	25
1D0HY-8-4	8	M14x1.5	1/4	2.36	60	17	1.00	25
1D0HY-10-4	10	M16x1.5	1/4	2.40	61	19	1.03	26
1D0HY-10-6	10	M16x1.5	3/8	2.42	61	19	1.06	27
1D0HY-12-6	12	M18x1.5	3/8	2.42	61	22	1.06	27
1D0HY-15-6	15	M22x1.5	3/8	2.52	64	24	1.16	29
1D0HY-15-8	15	M22x1.5	1/2	2.63	67	24	1.28	33
1D0HY-18-10	18	M26x1.5	5/8	2.71	69	27	1.31	33

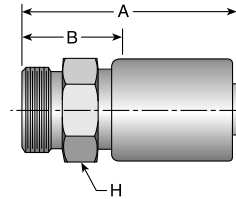

13DH

Male Standpipe Metric S - Rigid
ISO 8434-1

# Part Number	R mm	Hose I.D. inch	A		B	
			inch	mm	inch	mm
13DHY-16-8	16	1/2	3.53	90	2.16	55
13DHY-30-16	30	1	4.15	105	2.53	64

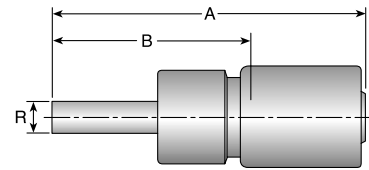

1D H

Male BSP Parallel Pipe - Rigid - (60 Cone)
ISO 228-1

# Part Number	Thread inch	Hose I.D. inch	A		H inch	B	
			inch	mm		inch	mm
1D9HY-4-4	1/4x19	1/4	2.40	61	13/16	1.03	26
1D9HY-6-6	3/8x19	3/8	2.55	65	7/8	1.19	30
1D9HY-8-6	1/2x14	3/8	2.65	67	1-1/16	1.28	33
1D9HY-8-8	1/2x14	1/2	2.83	72	1-1/16	1.47	37

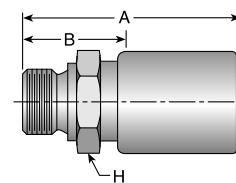

When used in a port, a bonded seal must be used. See Accessories Section for more information.

Metric L: Mates with EO "L" Series Fittings.
Metric S: Mates with EO "S" Series Fittings.

Hose
A

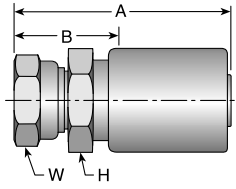

1 H
Female BSP Parallel Pipe - Swivel - (60 Cone)
ISO 228-1

# Part Number	Thread inch	Hose I.D. inch	A		H		B	
			inch	mm	inch	inch	inch	mm
1 UHY-4-4	1/4x19	1/4	2.62	67	9/16	11/16	1.28	33
1 UHY-6-4	3/8x19	1/4	2.69	68	3/4	7/8	1.34	34
1 UHY-6-6	3/8x19	3/8	2.70	69	3/4	7/8	1.34	34
1 UHY-8-6	1/2x14	3/8	2.84	72	7/8	1	1.50	38
1 UHY-8-8	1/2x14	1/2	3.02	77	7/8	1	1.66	42
1 UHY-12-12	3/4x14	3/4	3.25	83	1-1/4	1-1/4	1.69	43
1 UHY-16-16	1x11	1	3.45	88	1-3/8	1-1/2	1.84	47

Fittings
H Series
B

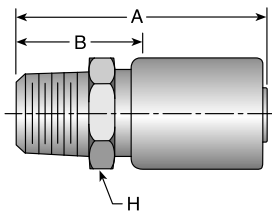

1 TH
Male BSP Taper Pipe - Rigid - (60 Cone)

# Part Number	Thread inch	Hose I.D. inch	A		H inch	B	
			inch	mm		inch	mm
1UTHY-2-4	1/8x28	1/4	2.34	59	9/16	1.00	25
1UTHY-4-4	1/4x19	1/4	2.53	64	9/16	1.19	30

Equipment
C

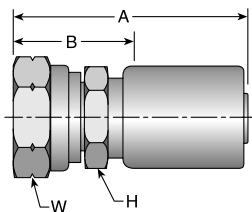











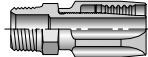

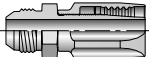
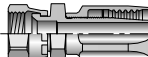
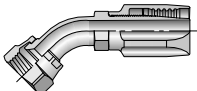
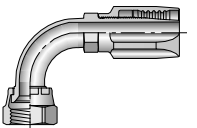



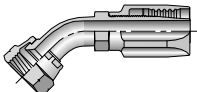
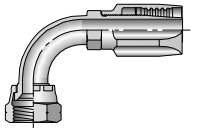
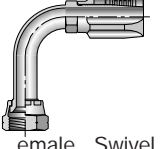

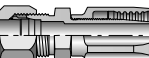
1 H
Female Metric Swivel - (30 Flare)

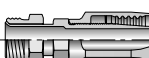
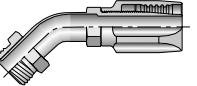
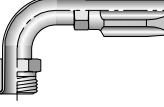
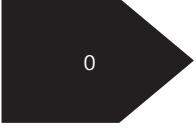
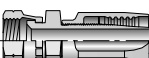
# Part Number	Thread mm		Hose I.D. inch	A		H		B	
				inch	mm	mm	mm	inch	mm
1XUHY-24-8	24	M24x1.5	1/2	3.14	80	22	30	1.72	44
1XUHY-24-10	24	M24x1.5	5/8	3.22	82	30	30	1.84	47
1XUHY-30-12	30	M30x1.5	3/4	3.31	84	32	38	1.75	44
1XUHY-33-16	33	M33x1.5	1	3.62	92	36	41	2.00	51

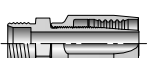
Accessories
D

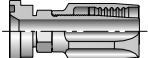
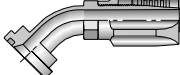
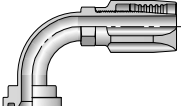
Technical
E

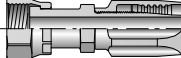
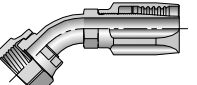
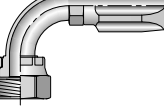
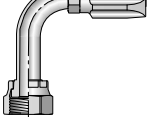

	20120 B-126  Male Rigid		20320 B-126  Male Rigid	20620 B-127  Female Swivel	23720 B-127  Female Swivel Elbow Short
23920 B-128  Female Swivel Elbow Short	24120 B-128  Female Swivel Elbow Long		20420 B-128  Male Rigid	20820 B-129  Female Swivel	27720 B-129  Female Swivel Elbow
27920 B-129  Female Swivel Elbow	28120 B-130  Female Swivel Elbow Long		21120 B-130  Male Rigid		22820 B-130  Male Swivel
26720 B-130  Male Swivel Elbow	26920 B-131  Male Swivel Elbow		23220 B-131  Female Swivel		26120 B-131  Male without Nut or Sleeve
	21520 B-131  Flange	21720 B-132  Female Swivel Elbow	21920 B-132  Female Swivel Elbow		2JS20 B-132  Female Swivel Elbow
2J720 B-132  Female Swivel Elbow	2J920 B-133  Female Swivel Elbow Short	2J120 B-133  Female Swivel Elbow Long		20 Series Assembly Instructions B-134	

Hose
A

Fittings
20 Series
B

Equipment
C

Accessories
D

Technical
E



Hose
A

Fittings
20 Series
B

Equipment
C

Accessories
D

Technical
E

20120

Male NPTF Pipe - Rigid

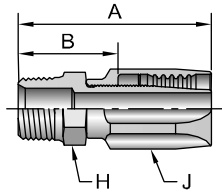

# Part Number	Thread		Hose I.D. inch	A		H		J		Additional Material Brass (B)
	inch			inch	mm	inch	inch	inch	mm	
20120-2-4	1/8x27		3/16	1.72	44	7/16	5/8	0.94	24	
20120-2-5	1/8x27		1/4	1.82	46	1/2	11/16	0.99	25	
20120-4-4	1/4x18		3/16	1.93	49	9/16	5/8	1.15	29	
20120-4-5	1/4x18		1/4	2.01	51	9/16	11/16	1.18	30	
20120-4-6	1/4x18		5/16	2.11	54	9/16	13/16	1.19	30	
20120-6-6	3/8x18		5/16	2.20	56	3/4	13/16	1.28	33	
20120-6-8	3/8x18		13/32	2.48	63	3/4	15/16	1.39	35	
20120-8-8	1/2x14		13/32	2.73	69	7/8	15/16	1.64	42	
20120-8-10	1/2x14		1/2	2.88	73	7/8	1-1/8	1.66	42	
20120-12-10	3/4x14		1/2	2.95	75	1-1/16	1-1/8	1.73	44	
20120-12-12	3/4x14		5/8	3.25	83	1-1/16	1-1/4	1.75	44	
20120-12-16	3/4x14		7/8	2.81	71	1-3/8	1-7/16	1.62	41	
20120-16-16	1x11-1/2		7/8	2.99	76	1-3/8	1-7/16	1.80	46	
20120-20-20	1-1/4x11-1/2		1-1/8	3.24	82	1-3/4	1-3/4	1.96	50	
20120-24-24	1-1/2x11-1/2		1-3/8	3.50	89	2	2	2.13	54	
20120-32-32	2 x11-1/2		1-13/16	4.05	103	2-1/2	2-1/2	2.31	59	

20320

Male JIC 37 - Rigid

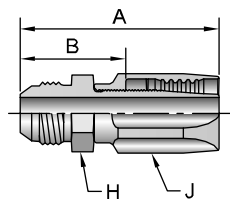

# Part Number	Thread		Hose I.D. inch	A		H		J	
	inch			inch	mm	inch	inch	inch	mm
20320-4-4	1/4	7/16x20	3/16	1.83	46	1/2	5/8	1.05	27
20320-5-5	5/16	1/2x20	1/4	1.94	49	9/16	11/16	1.11	28
20320-6-6	3/8	9/16x18	5/16	2.11	54	5/8	13/16	1.19	30
20320-8-8	1/2	3/4x16	13/32	2.57	65	13/16	15/16	1.48	38
20320-10-10	5/8	7/8x14	1/2	2.88	73	15/16	1-1/8	1.66	42
20320-12-12	3/4	1-1/16x12	5/8	3.35	85	1-1/8	1-1/4	1.85	47
20320-16-16	1	1-5/16x12	7/8	2.95	75	1-3/8	1-7/16	1.76	45

20620
Female JIC 37 - Swivel

# Part Number	Thread		Hose I.D. inch	A		H inch	J inch	inch	B		Additional Material Stainless Steel (C)
	inch	inch		inch	mm				inch	mm	
20620-4-4	1/4	7/16x20	3/16	1.94	49	9/16	5/8	9/16	1.16	29	
20620-4-5	1/4	7/16x20	1/4	2.04	52	9/16	11/16	9/16	1.21	31	
20620-5-5	5/16	1/2x20	1/4	2.12	54	5/8	11/16	5/8	1.29	33	
20620-6-5	3/8	9/16x18	1/4	2.19	56	11/16	11/16	11/16	1.36	35	
20620-6-6	3/8	9/16x18	5/16	2.32	59	11/16	13/16	11/16	1.40	36	
20620-8-6	1/2	3/4x16	5/16	2.44	62	7/8	13/16	7/8	1.52	39	
20620-8-8	1/2	3/4x16	13/32	2.79	71	7/8	15/16	7/8	1.70	43	
20620-8-10	1/2	3/4x16	1/2	2.99	76	7/8	1-1/8	7/8	1.77	45	
20620-10-8	5/8	7/8x14	13/32	2.94	75	7/8	15/16	1	1.85	47	
20620-10-10	5/8	7/8x14	1/2	3.10	79	1	1-1/8	1	1.88	48	
20620-10-12	5/8	7/8x14	5/8	3.40	86	1	1-1/4	1	1.90	48	
20620-12-12	3/4	1-1/16x12	5/8	3.49	89	1-1/4	1-1/4	1-1/4	1.99	51	
20620-16-16	1	1-5/16x12	7/8	3.20	81	1-1/2	1-7/16	1-1/2	2.01	51	
20620-20-20	1-1/4	1-5/8x12	1-1/8	3.56	90	2	1-3/4	2	2.28	58	
20620-24-24	1-1/2	1-7/8x12	1-3/8	3.95	100	2-1/4	2	2-1/4	2.58	66	
20620-32-32	2	2-1/2x12	1-13/16	4.71	120	2-7/8	2-1/2	2-7/8	2.97	75	

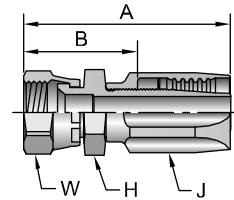

23720
Female JIC 37 - Swivel - 45 Elbow - Short Drop

# Part Number	Thread		Hose I.D. inch	A		E		H inch	J inch	inch	B	
	inch	inch		inch	mm	inch	mm				inch	mm
23720-4-4	1/4	7/16x20	3/16	2.08	53	0.33	8	3/8	5/8	9/16	1.30	33
23720-5-5	5/16	1/2x20	1/4	2.30	58	0.36	9	7/16	11/16	5/8	1.47	37
23720-6-6	3/8	9/16x18	5/16	2.45	62	0.39	10	1/2	13/16	11/16	1.53	39
23720-8-6	1/2	3/4x16	5/16	2.77	70	0.55	14	5/8	13/16	7/8	1.85	47
23720-10-10	5/8	7/8x14	1/2	3.36	85	0.65	17	3/4	1-1/8	1	2.14	54
23720-12-12	3/4	1-1/16x12	5/8	3.94	100	0.79	20	7/8	1-1/4	1-1/4	2.44	62
23720-16-16	1	1-5/16x12	7/8	3.73	95	0.90	23	1-1/8	1-7/16	1-1/2	2.54	65
23720-20-20	1-1/4	1-5/8x12	1-1/8	4.17	106	1.19	30	1-1/2	1-3/4	2	2.89	73

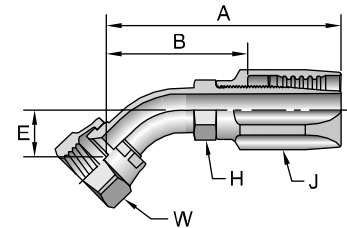

Hose
A

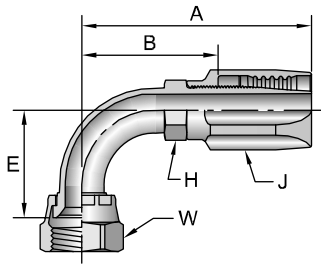

23 20

Female JIC 37 - Swivel - 0 Elbow - Short Drop

#	Thread		Hose I.D.	A		E		H	J	B		
	inch	inch		inch	mm	inch	mm				inch	mm
23920-4-4	1/4	7/16x20	3/16	1.91	49	0.83	21	3/8	5/8	9/16	1.13	29
23920-5-5	5/16	1/2x20	1/4	2.30	58	0.77	20	7/16	11/16	5/8	1.47	37
23920-6-6	3/8	9/16x18	5/16	2.35	60	0.90	23	1/2	13/16	11/16	1.43	36
23920-8-8	1/2	3/4x16	13/32	2.88	73	1.09	28	5/8	15/16	7/8	1.79	45
23920-10-10	5/8	7/8x14	1/2	3.20	81	1.24	31	3/4	1-1/8	1	1.98	50
23920-12-12	3/4	1-1/16x12	5/8	3.86	98	1.82	46	7/8	1-1/4	1-1/4	2.36	60
23920-16-16	1	1-5/16x12	7/8	3.69	94	2.14	54	1-1/8	1-7/16	1-1/2	2.50	64
23920-20-20	1-1/4	1-5/8x12	1-1/8	4.01	102	2.59	66	1-1/2	1-3/4	2	2.73	69
23920-24-24	1-1/2	1-7/8x12	1-3/8	4.43	113	2.82	72	1-3/4	2	2-1/4	3.06	78

Fittings
20 Series
B

24120

Female JIC 37 - Swivel - 0 Elbow - Long Drop

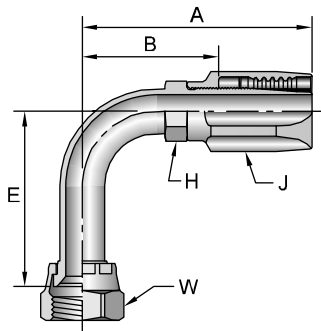

#	Thread		Hose I.D.	A		E		H	J	B		
	inch	inch		inch	mm	inch	mm				inch	mm
24120-4-4	1/4	7/16x20	3/16	2.08	53	1.80	46	3/8	5/8	9/16	1.30	33
24120-6-6	3/8	9/16x18	5/16	2.34	59	2.18	55	1/2	13/16	11/16	1.42	36
24120-8-8	1/2	3/4x16	13/32	2.95	75	2.43	62	5/8	15/16	7/8	1.86	47
24120-10-10	5/8	7/8x14	1/2	3.26	83	2.58	66	3/4	1-1/8	1	2.04	52
24120-12-12	3/4	1-1/16x12	5/8	3.78	96	3.74	95	7/8	1-1/4	1-1/4	2.28	58

Equipment
C

20420

Male SAE 45 - Rigid

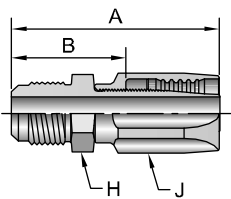

#	Thread		Hose I.D.	A		H	J	B	
	inch	inch		inch	mm			inch	mm
20420-4-4	1/4	7/16x20	3/16	1.80	46	1/2	5/8	1.02	26
20420-5-5	5/16	1/2x20	1/4	1.94	49	9/16	11/16	1.11	28
20420-6-6	3/8	5/8x18	5/16	2.17	55	11/16	13/16	1.25	32
20420-8-8	1/2	3/4x16	13/32	2.67	68	13/16	15/16	1.58	40
20420-10-10	5/8	7/8x14	1/2	3.00	76	15/16	1-1/8	1.78	45
20420-12-12	3/4	1-1/16x14	5/8	3.50	89	1-1/8	1-1/4	2.00	51

Accessories
D

Technical
E

20820

Female SAE 45 - Swivel

# Part Number	Thread		Hose I.D. inch	A		H inch	J inch	inch	B	
	inch	inch		inch	mm				inch	mm
20820-4-4	1/4	7/16x20	3/16	1.94	49	9/16	5/8	9/16	1.16	29
20820-4-5	1/4	7/16x20	1/4	2.04	52	9/16	11-16	9/16	1.21	31
20820-5-5	5/16	1/2x20	1/4	2.12	54	5/8	11-16	5/8	1.29	33
20820-6-6	3/8	5/8x18	5/16	2.36	60	3/4	13/16	3/4	1.44	37
20820-8-8	1/2	3/4x16	3/8	2.79	71	7/8	15/16	7/8	1.70	43
20820-8-10	1/2	3/4x16	1/2	2.99	76	7/8	1-1/8	7/8	1.77	45
20820-10-10	5/8	7/8x14	1/2	3.10	79	1	1-1/8	1	1.88	48
20820-12-12	3/4	1-1/16x14	5/8	3.49	89	1-1/4	1-1/4	1-1/4	1.99	51

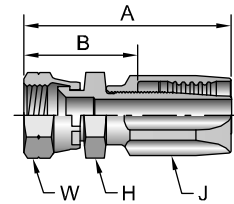

27720

Female SAE 45 - Swivel - 45 Elbow

# Part Number	Thread		Hose I.D. inch	A		E		H inch	J inch	inch	B	
	inch	inch		inch	mm	inch	mm				inch	mm
27720-6-6	3/8	5/8x18	5/16	2.45	62	0.39	10	1/2	13/16	3/4	1.53	39
27720-8-6	1/2	3/4x16	5/16	2.77	71	0.55	14	5/8	13/16	7/8	1.86	47
27720-8-8	1/2	3/4x16	13/32	3.09	78	0.55	14	5/8	15/16	7/8	2.00	51
27720-10-10	5/8	7/8x14	1/2	3.35	85	0.65	17	3/4	1-1/8	1	2.13	54

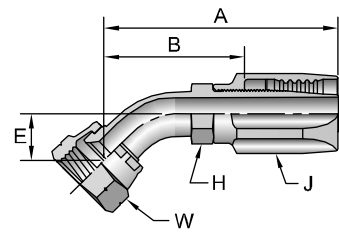

27 20

Female SAE 45 - Swivel - 0 Elbow

# Part Number	Thread		Hose I.D. inch	A		E		H inch	J inch	inch	B	
	inch	inch		inch	mm	inch	mm				inch	mm
27920-4-4	1/4	7/16x20	3/16	1.91	49	0.83	21	3/8	5/8	9/16	1.13	29
27920-5-5	5/16	1/2x20	1/4	2.30	58	0.77	20	7/16	11/16	5/8	1.47	37
27920-6-6	3/8	5/8x18	5/16	2.33	59	0.85	22	1/2	13/16	3/4	1.41	36
27920-8-8	1/2	3/4x16	13/32	2.86	73	1.09	28	5/8	15/16	7/8	1.77	45
27920-10-10	5/8	7/8x14	1/2	3.20	81	1.24	31	3/4	1-1/8	1	1.98	50
27920-12-12	3/4	1-1/16x14	5/8	3.87	98	1.82	46	7/8	1-1/4	1-1/4	2.37	60

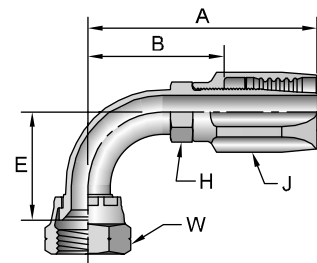

Notch in nut signifies 45 flare.

Hose
A

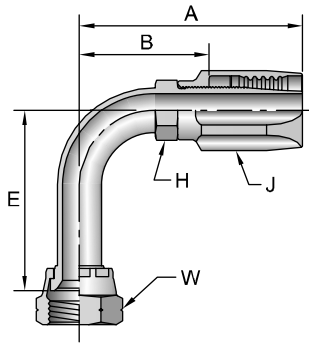

28120

Female SAE 45 - Swivel - 90° Elbow - Long Drop

#	Thread		Hose I.D.	A		E		H	J		B	
Part Number	inch	mm	inch	inch	mm	inch	mm	inch	inch	inch	inch	mm
28120-6-6	3/8	5/8x18	5/16	2.34	59	2.18	55	1/2	13/16	3/4	1.42	36
28120-8-8	1/2	3/4x16	13/32	2.95	75	2.43	62	5/8	15/16	7/8	1.86	47

Notch in nut signifies 45° flare.

Fittings
20 Series
B

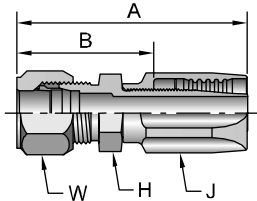

21120

Male Ferulok Flareless - Rigid
(24° Cone with Nut and Ferrule)

#	Thread		Hose I.D.	A		H	J		B	
Part Number	inch	mm	inch	inch	mm	inch	inch	inch	inch	mm
21120-6-6	3/8	9/16x18	5/16	2.05	52	5/8	13/16	11/16	1.13	29
21120-8-8	1/2	3/4x16	13/32	2.52	64	13/16	15/16	7/8	1.43	36

The Parker Ferrule-Fix fitting makes it possible to salvage the bent tube section from a hose assembly for quick, easy on the job repairs. For additional information see Ferrule-Fix installation instructions in the Technical Section.

Equipment
C

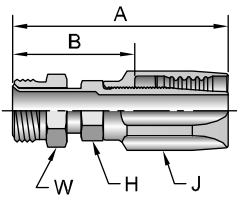

22820

Male Inverted SAE 45 - Swivel

#	Thread		Hose I.D.	A		H	J		B	
Part Number	inch	mm	inch	inch	mm	inch	inch	inch	inch	mm
22820-4-4	1/4	7/16x24	3/16	2.45	62	3/8	5/8	7/16	1.67	42
22820-5-5	5/16	1/2x20	1/4	2.70	69	7/16	11/16	1/2	1.87	47
22820-6-6	3/8	5/8x18	5/16	2.95	75	1/2	13/16	5/8	2.03	52
22820-8-8	1/2	3/4x18	13/32	3.36	85	5/8	15/16	3/4	2.27	58
22820-10-10	5/8	7/8x18	1/2	3.64	92	3/4	1-1/8	7/8	2.42	61

Accessories
D

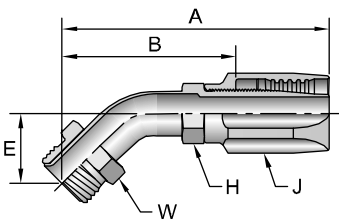

26720

Male Inverted SAE 45 - Swivel - 45° Elbow

#	Thread		Hose I.D.	A		E		H	J		B	
Part Number	inch	mm	inch	inch	mm	inch	mm	inch	inch	inch	inch	mm
26720-4-4	1/4	7/16x24	3/16	2.21	56	0.62	16	3/8	5/8	7/16	1.43	36
26720-5-5	5/16	1/2x20	1/4	2.44	62	0.70	18	7/16	11/16	1/2	1.61	41
26720-6-6	3/8	5/8x18	5/16	3.00	76	0.94	24	1/2	13/16	5/8	2.08	53
26720-8-8	1/2	3/4x18	13/32	3.51	89	1.09	28	5/8	15/16	3/4	2.42	61

Technical
E

26 20

Male Inverted SAE 45 - Swivel - 90° Elbow

#	Thread		Hose I.D.	A		E	H	J	K	B		
	inch	mm		inch	mm					inch	mm	
26920-4-4	1/4	7/16x24	3/16	2.29	58	1.56	40	3/8	5/8	7/16	1.51	38
26920-5-5	5/16	1/2x20	1/4	2.55	65	1.65	42	7/16	11/16	1/2	1.72	44
26920-5-6	5/16	1/2x20	5/16	2.63	67	1.65	42	1/2	13/16	1/2	1.71	43
26920-6-6	3/8	5/8x18	5/16	2.67	68	1.69	43	1/2	13/16	5/8	1.75	44
26920-8-8	1/2	3/4x18	13/32	3.09	78	1.88	48	5/8	15/16	3/4	2.00	51

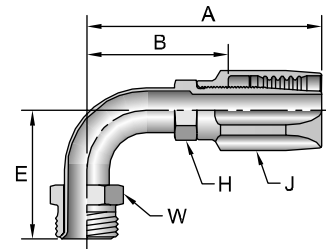

23220

Female PTT 30 - Swivel

#	Thread		Hose I.D.	A		H	J	K	B	
	inch	mm		inch	mm				inch	mm
23220-16-16	1	1-5/16x14	7/8	2.98	76	1-1/2	1-7/16	1-1/2	1.79	45

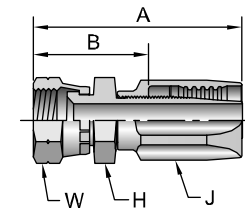

26120

Male SAE Compression Seat
 (without Nut or Sleeve)

#	Thread		Hose I.D.	A		H	J	B	
	inch	mm		inch	mm			inch	mm
26120-10-10	5/8	13/16x18	1/2	2.64	67	7/8	1-1/8	1.42	36

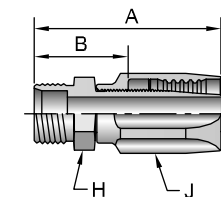

21520

SAE Code 61 Flange Head
 ISO 12151-3-S-L

#	Flange	Hose I.D.	A		F	H	J	B	
			inch	mm				inch	mm
21520-20-20	1-1/4	1-1/8	3.58	91	2	1-1/2	1-3/4	2.30	58
21520-40-40	2-1/2	2-3/8	5.22	133	3-5/16	2-3/4	3-1/8	3.41	87

See Accessories Section for O-Rings and Flange Kits.

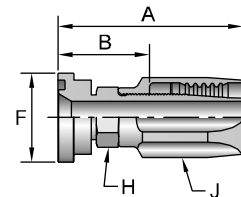

Hose

A

Fittings
20 Series

B

Equipment

C

Accessories

D

Technical

E

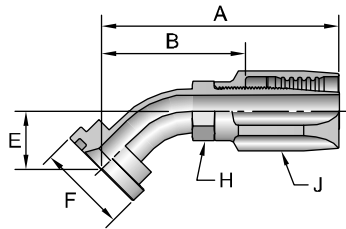

21720

SAE Code 61 Flange Head - 45 Elbow
ISO 12151-3- E45S - L (1 Piece: ISO 12151-3- E45M - L)

#			A		E					B	
Part Number	Flange inch	Hose I.D. inch	inch	mm	inch	mm	inch	inch	inch	inch	mm
21720-20-20	1-1/4	1-1/8	4.10	104	1.12	28	2	1-1/2	1-3/4	2.82	72
21720-40-40	2-1/2	2-3/8	5.83	148	1.41	36	3-3/8	2-3/4	3-1/8	4.02	102

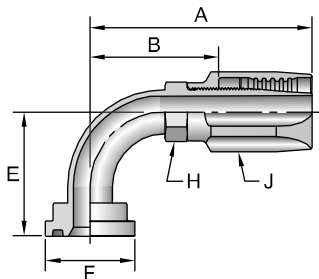

21920

SAE Code 61 Flange Head - 90 Elbow
ISO 12151-3- E90S - L (1 Piece: ISO 12151-3- E90M - L)

#			A		E					B	
Part Number	Flange inch	Hose I.D. inch	inch	mm	inch	mm	inch	inch	inch	inch	mm
21920-8-8	1/2	13/32	2.95	75	1.62	41	1-3/16	5/8	15/16	1.86	47
21920-32-32	2	1-13/16	5.44	138	3.19	81	2-13/16	2-1/4	2-1/2	3.70	94
21920-40-40	2-1/2	2-3/8	6.18	157	3.75	95	3-5/16	2-3/4	3-1/8	4.37	111

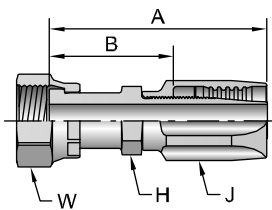

2JS20

Female Seal-Lok - Swivel - Long
ISO 12151-1 - SWSB

#			A					B		
Part Number	Thread inch	Hose I.D. inch	inch	mm	inch	inch	inch	inch	mm	
2JS20-4-4	1/4	9/16x18	3/16	2.07	53	9/16	5/8	11/16	1.29	33
2JS20-6-6	3/8	11/16x16	5/16	2.36	60	1/2	13/16	13/16	1.44	37
2JS20-8-8	1/2	13/16x16	13/32	2.92	74	5/8	15/16	15/16	1.83	46
2JS20-10-10	5/8	1x14	1/2	3.15	80	3/4	1-1/8	1-1/8	1.93	49
2JS20-12-12	3/4	1-3/16x12	5/8	3.66	93	1-1/8	1-1/4	1-3/8	2.16	55

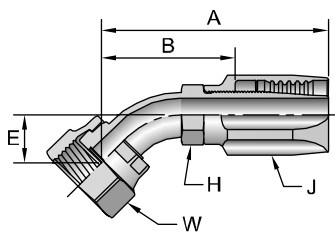

2J720

Female Seal-Lok - Swivel - 45 Elbow
ISO 12151-1 - SWE45

#			A		E					B		
Part Number	Thread inch	Hose I.D. inch	inch	mm	inch	mm	inch	inch	inch	inch	mm	
2J720-4-4	1/4	9/16x18	3/16	2.24	57	0.41	10	7/16	5/8	11/16	1.46	37
2J720-6-6	3/8	11/16x16	5/16	2.52	64	0.43	11	1/2	13/16	13/16	1.60	41
2J720-8-8	1/2	13/16x16	13/32	3.19	81	0.59	15	5/8	15/16	15/16	2.10	53
2J720-10-10	5/8	1x14	1/2	3.46	88	0.65	17	3/4	1-1/8	1-1/8	2.24	57

See Accessories Section for O-Rings and Flange Kits.

Hose
A
 Fittings
 20 Series
B
 Equipment
C
 Accessories
D
 Technical
E

2J 20

Female Seal-Lok - Swivel O Elbow - Short Drop
ISO 12151-1 - SWE90

# Part Number	Thread		Hose I.D. inch	A		E		H inch	J inch	B inch	B	
	inch	mm		inch	mm	inch	mm				inch	mm
2J920-4-4	1/4	9/16x18	3/16	2.22	56	0.82	21	7/16	5/8	11/16	1.44	37
2J920-6-6	3/8	11/16x16	5/16	2.39	61	0.90	23	1/2	13/16	13/16	1.47	37
2J920-8-8	1/2	13/16x16	13/32	2.91	74	1.15	29	5/8	15/16	15/16	1.82	46
2J920-10-10	5/8	1x14	1/2	3.16	80	1.27	32	3/4	1-1/8	1-1/8	1.94	49
2J920-12-12	3/4	1-3/16x12	5/8	3.74	95	1.85	47	7/8	1-1/4	1-3/8	2.24	57

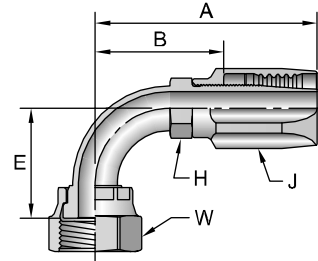

2J120

Female Seal-Lok - Swivel - O Elbow - Long Drop
ISO 12151-1 - SWEL90

# Part Number	Thread		Hose I.D. inch	A		E		H inch	J inch	B inch	B	
	inch	mm		inch	mm	inch	mm				inch	mm
2J120-4-4	1/4	9/16x18	3/16	2.01	51	1.80	46	7/16	5/8	11/16	1.23	31
2J120-6-6	3/8	11/16x16	5/16	2.48	63	2.13	54	1/2	13/16	13/16	1.56	40
2J120-8-8	1/2	13/16x16	13/32	2.96	75	2.51	64	5/8	15/16	15/16	1.87	47

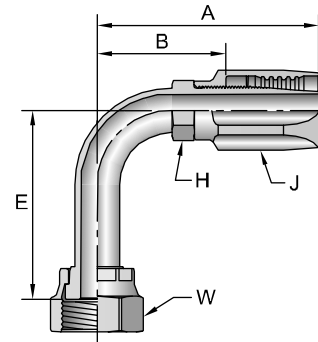

See Accessories Section for O-Rings.

Hose
 A
 Fittings
 20 Series
 B
 Equipment
 C
 Accessories
 D
 Technical
 E

20 Series Hose Assembly Instructions

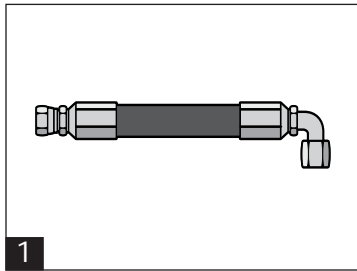

1. Identify over all length (OAL) of hose assembly and the cut off allowance (COA) length of fitting(s) on hose ends by use of the fitting data table. Properly measure, mark and cut hose to desired length using fine tooth hacksaw or cutoff machine. Care should be taken to ensure a square, clean cut is obtained.

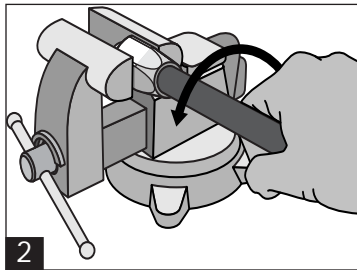

2. Air or solvent flush cut end of hose as necessary to produce a clean hose ID prior to assembly. Place socket in vice and screw in hose counter clockwise until hose bottoms. Back hose out turn.

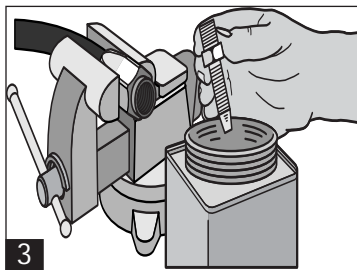

3. Oil inside of hose and nipple threads liberally with Hoze-Oil. (See Section C). Do not oil hose cover.

4. Screw nipple assembly into socket using a wrench on the nipple hex until the nipple hex shoulders against the socket. A 1/32" to 1/16" gap between the nipple hex and socket is allowed for displacement angle adjustment when two elbow fittings are used.

Inspection. Examine hose assembly internally for cut or bulged tube, obstructions and cleanliness. Clean ID of hose as necessary. Swivel nuts should turn freely. Check the layline of the hose to be sure the assembly is not twisted. Cap the ends of the assembly to keep clean.

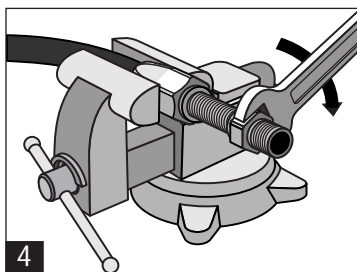

Special Instructions for stainless steel fittings. When assembling fittings made with 316 stainless steel, lubricate the threads of both the socket and nipple with Accrolube High Efficiency Lubricant (see Section C) or equivalent metal assembly lubricant.











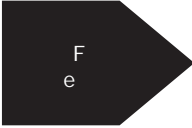

Note DISASSEMBLE IN REVERSE ORDER

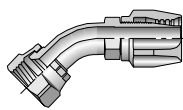
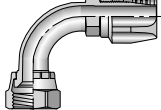
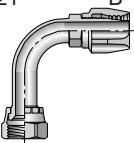
IF YOU HAVE QUESTIONS CONCERNING THE PRODUCTS OR APPLICATION OF THE PRODUCTS CONTAINED IN THIS CATALOG, PLEASE CALL: PARKER HOSE PRODUCTS DIVISION - TECHNICAL SERVICES DEPARTMENT

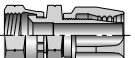
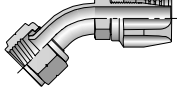
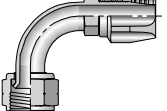
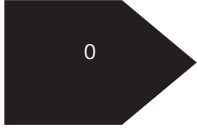
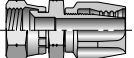
PHONE: 440/943-5700

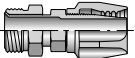
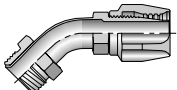
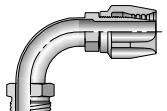
FAX: 440/943-3129

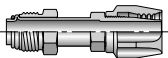
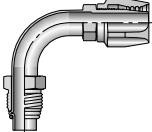
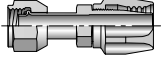
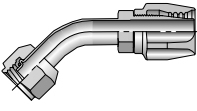
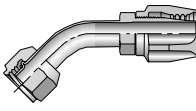
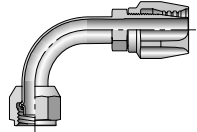
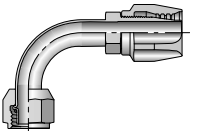
<http://www.parkerhose.com>

	20121 B-136  Male Rigid		20621 B-136  Female Swivel	23721 B-136  Female Swivel Elbow Short	23921 B-137  Female Swivel Elbow Short
24121 B-137  Female Swivel Elbow Long		20821 B-137  Female Swivel	27721 B-137  Female Swivel Elbow	27921 B-138  Female Swivel Elbow	
23221 B-138  Female Swivel		22821 B-138  Female Swivel	26721 B-138  Female Swivel Elbow	26921 B-139  Female Swivel Elbow	
2S521 B-139  Female Swivel Short	25M21 B-139  Female Swivel Elbow Long	25S21 B-139  Female Swivel Short	25H21 B-140  Female Swivel Elbow Short	25N21 B-140  Female Swivel Elbow Long	25T21 B-140  Female Swivel Elbow Short
25L21 B-140  Female Swivel Elbow Long		21 Series B-141 Assembly Instructions			

Hose	A
Fittings 21 Series	B
Equipment	C
Accessories	D
Technical	E



Hose
A

Fittings
21 Series
B

Equipment
C

Accessories
D

Technical
E

20121 Male NPTF Pipe - Rigid

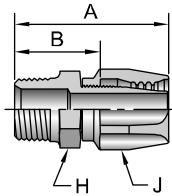

# Part Number	Thread		Hose I.D. inch	A		H inch	J inch	B	
	inch	inch		inch	mm			inch	mm
20121-2-4	1/8x27	3/16	1.55	39	7/16	9/16	0.88	22	
20121-4-4	1/4x18	3/16	1.77	45	9/16	9/16	1.10	28	
20121-4-5	1/4x18	1/4	1.79	45	9/16	5/8	1.05	27	
20121-4-6	1/4x18	5/16	1.92	49	9/16	3/4	1.14	29	
20121-6-6	3/8x18	5/16	1.95	50	11/16	3/4	1.17	30	
20121-6-8	3/8x18	13/32	2.10	53	11/16	7/8	1.18	30	
20121-8-8	1/2x14	13/32	2.34	59	7/8	7/8	1.42	36	
20121-8-10	1/2x14	1/2	2.44	62	7/8	1-1/16	1.44	37	
20121-12-12	3/4x14	5/8	2.58	66	1-1/8	1-1/4	1.50	38	
20121-12-16	3/4x14	7/8	2.50	64	1-1/4	1-7/16	1.51	38	
20121-16-16	1x11-1/2	7/8	2.69	68	1-3/8	1-7/16	1.70	43	
20121-20-20	1-1/4x11-1/2	1-1/8	2.91	74	1-11/16	1-3/4	1.87	47	
20121-24-24	1-1/2x11-1/2	1-3/8	3.02	77	2	2	1.92	49	

20621 Female JIC 37 - Swivel

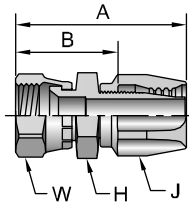

# Part Number	Thread		Hose I.D. inch	A		H inch	J inch	inch	B	
	inch	inch		inch	mm				inch	mm
20621-4-4	1/4	7/16x20	3/16	1.83	46	9/16	9/16	9/16	1.16	29
20621-5-5	5/16	1/2x20	1/4	1.92	49	5/8	5/8	5/8	1.18	30
20621-6-6	3/8	9/16x18	5/16	2.09	53	11/16	3/4	11/16	1.31	33
20621-8-8	1/2	3/4x16	13/32	2.46	62	7/8	7/8	7/8	1.54	39
20621-8-10	1/2	3/4x16	1/2	2.56	65	1	1-1/16	7/8	1.56	40
20621-10-10	5/8	7/8x14	1/2	2.65	67	1	1-1/16	1	1.65	42
20621-12-12	3/4	1-1/16x12	5/8	2.85	72	1-1/4	1-1/4	1-1/4	1.77	45
20621-16-16	1	1-5/16x12	7/8	2.94	75	1-1/2	1-7/16	1-1/2	1.95	50
20621-20-20	1-1/4	1-5/8x12	1-1/8	3.16	80	2	1-3/4	2	2.12	54

23721 Female JIC 37 - Swivel - 45 Elbow - Short Drop

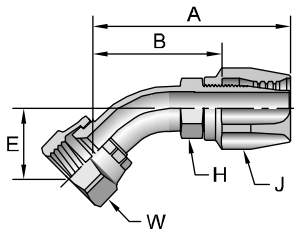

# Part Number	Thread		Hose I.D. inch	A		E		H inch	J inch	inch	B	
	inch	inch		inch	mm	inch	mm				inch	mm
23721-4-4	1/4	7/16x20	3/16	2.11	54	0.39	10	3/8	9/16	9/16	1.43	36
23721-6-6	3/8	9/16x18	5/16	2.26	57	0.40	10	1/2	3/4	11/16	1.48	38
23721-8-8	1/2	3/4x16	13/32	2.73	69	0.55	14	5/8	7/8	7/8	1.81	46
23721-10-10	5/8	7/8x14	1/2	2.97	75	0.64	16	3/4	1-1/16	1	1.97	50
23721-12-12	3/4	1-1/16x12	5/8	3.30	84	0.83	21	7/8	1-1/4	1-1/4	2.22	56
23721-16-16	1	1-5/16x12	7/8	3.44	87	0.90	23	1-1/8	1-7/16	1-1/2	2.45	62
23721-20-20	1-1/4	1-5/8x12	1-1/8	3.80	97	1.19	30	1-3/8	1-3/4	2	2.76	70

23 21

Female JIC 37 - Swivel - 0 Elbow - Short Drop

# Part Number	Thread		Hose I.D. inch	A		E		H inch	J inch	B inch	B	
	inch	mm		inch	mm	inch	mm				inch	mm
23921-4-4	1/4	7/16 x 20	3/16	1.88	48	0.83	21	3/8	9/16	9/16	1.20	30
23921-4-6	1/4	7/16 x 20	5/16	1.95	50	0.83	21	1/2	3/4	9/16	1.17	30
23921-5-5	5/16	1/2 x 20	1/4	2.07	53	0.77	20	7/16	5/8	5/8	1.33	34
23921-6-6	3/8	9/16x18	5/16	2.15	55	0.85	22	1/2	3/4	11/16	1.37	35
23921-8-8	1/2	3/4 x 16	13/32	2.49	63	1.09	28	5/8	7/8	7/8	1.57	40
23921-10-10	5/8	7/8 x 14	1/2	2.69	68	1.23	31	3/4	1-1/16	1	1.69	43
23921-12-12	3/4	1-1/16 x 12	5/8	2.88	73	1.89	48	7/8	1-1/4	1-1/4	1.80	46
23921-16-16	1	1-5/16 x 12	7/8	3.40	86	2.14	54	1-1/8	1-7/16	1-1/2	2.41	61
23921-20-20	1-1/4	1-5/8 x 12	1-1/8	3.64	92	2.59	66	1-3/8	1-3/4	2	2.60	66

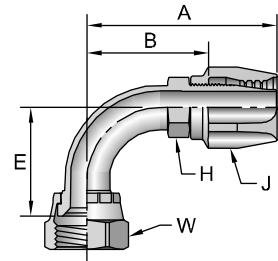

24121

Female JIC 37 - Swivel - 0 Elbow - Long Drop

# Part Number	Thread		Hose I.D. inch	A		E		H inch	J inch	B inch	B	
	inch	mm		inch	mm	inch	mm				inch	mm
24121-4-4	1/4	7/16x20	3/16	1.88	48	2.52	64	3/8	9/16	9/16	1.20	30
24121-6-6	3/8	9/16x18	5/16	2.14	54	2.18	55	1/2	3/4	11/16	1.36	35
24121-8-8	1/2	3/4x16	13/32	2.45	62	2.52	64	5/8	7/8	7/8	1.53	39
24121-10-10	5/8	7/8x14	1/2	2.91	74	2.57	65	3/4	1-1/16	1	1.91	49
24121-20-20	1-1/4	1-5/8x12	1-1/8	3.63	92	5.28	134	1-3/8	1-3/4	2	2.59	66

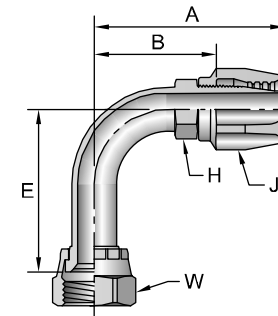

20821

Female SAE 45 - Swivel

# Part Number	Thread		Hose I.D. inch	A		H inch	J inch	B inch	B	
	inch	mm		inch	mm				inch	mm
20821-4-4	1/4	7/16x20	3/16	1.83	46	9/16	9/16	9/16	1.16	29
20821-5-5	5/16	1/2x20	1/4	1.91	49	5/8	5/8	5/8	1.17	30
20821-6-6	3/8	5/8x18	5/16	2.12	54	3/4	3/4	3/4	1.34	34
20821-8-8	1/2	3/4x16	13/32	2.46	62	7/8	7/8	7/8	1.54	39
20821-10-10	5/8	7/8x14	1/2	2.65	67	1	1-1/16	1	1.65	42
20821-12-12	3/4	1-1/16x14	5/8	2.85	72	1-1/4	1-1/4	1-1/4	1.77	45

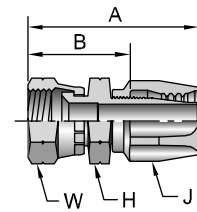

27721

Female SAE 45 - Swivel - 45 Elbow

# Part Number	Thread		Hose I.D. inch	A		E		H inch	J inch	B inch	B	
	inch	mm		inch	mm	inch	mm				inch	mm
27721-6-6	3/8	5/8x18	5/16	2.26	57	0.40	10	1/2	3/4	3/4	1.48	38
27721-12-12	3/4	1-1/16x14	5/8	3.30	84	0.83	21	7/8	1-1/4	1-1/4	2.22	56

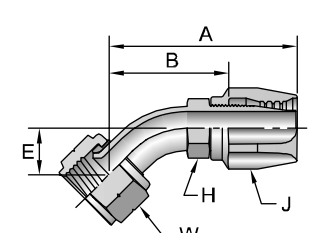

Notch in nut signifies 45 flare.

Hose
A
Fittings 21 Series
B
Equipment
C
Accessories
D
Technical
E

Hose
A

Fittings
21 Series
B

Equipment
C

Accessories
D

Technical
E

27 21
Female SAE 45 - Swivel - 0 Elbow

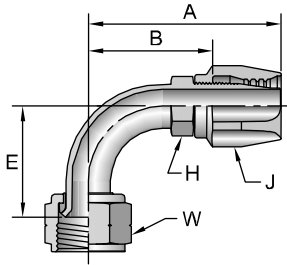

# Part Number	Thread inch		Hose I.D. inch	A		E		H inch	J inch	inch	B	
	inch	mm		inch	mm	inch	mm				inch	mm
27921-6-6	3/8	5/8x18	5/16	2.15	55	0.85	22	1/2	3/4	3/4	1.37	35
27921-12-12	3/4	1-1/16x14	5/8	2.88	73	1.89	48	7/8	1-1/4	1-1/4	1.89	46

Notch in nut signifies 45 flare.

23221
Female PTT 30 - Swivel

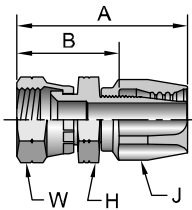

# Part Number	Thread inch		Hose I.D. inch	A		H inch	J inch	inch	B	
	inch	mm		inch	mm				inch	mm
23221-16-16	1	1-5/16x14	7/8	2.70	69	1-1/2	1-7/16	1-1/2	1.71	43

22821
Male Inverted SAE 45 - Swivel

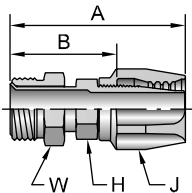

# Part Number	Thread inch		Hose I.D. inch	A		H inch	J inch	inch	B	
	inch	mm		inch	mm				inch	mm
22821-4-4	1/4	7/16x24	3/16	2.36	60	3/8	9/16	7/16	1.68	43
22821-5-4	5/16	1/2x20	3/16	2.32	59	7/16	9/16	1/2	1.64	42
22821-5-5	5/16	1/2x20	1/4	2.34	59	7/16	5/8	1/2	1.60	41
22821-5-6	5/16	1/2x20	5/16	2.47	63	1/2	3/4	1/2	1.69	43
22821-6-6	3/8	5/8x18	5/16	2.45	62	1/2	3/4	5/8	1.67	42
22821-8-8	1/2	3/4x18	13/32	2.84	72	5/8	7/8	3/4	1.92	49
22821-10-10	5/8	7/8x18	1/2	2.91	74	3/4	1-1/16	7/8	1.91	49

26721
Male Inverted SAE 45 - Swivel - 45 Elbow

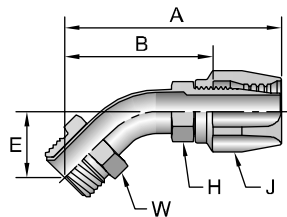

# Part Number	Thread inch		Hose I.D. inch	A		E		H inch	J inch	inch	B	
	inch	mm		inch	mm	inch	mm				inch	mm
26721-4-4	1/4	7/16x24	3/16	2.35	60	0.62	16	3/8	9/16	7/16	1.67	42
26721-5-5	5/16	1/2x20	1/4	2.59	66	0.94	24	7/16	5/8	1/2	1.85	47
26721-6-6	3/8	5/8x18	5/16	2.73	69	0.94	24	1/2	3/4	5/8	1.95	50
26721-8-8	1/2	3/4x18	13/32	3.05	77	0.94	24	5/8	7/8	3/4	2.13	54

26 21

Male Inverted SAE 45 - Swivel - 0 Elbow

# Part Number	Thread inch	Hose I.D. inch	A		E		H inch	J inch	K inch	B		
			inch	mm	inch	mm				inch	mm	
26921-4-4	1/4	7/16x24	3/16	2.45	62	1.56	40	3/8	9/16	7/16	1.77	45
26921-5-5	5/16	1/2x20	1/4	2.25	57	1.65	42	7/16	5/8	1/2	1.51	38
26921-5-6	5/16	1/2x20	5/16	2.38	60	1.65	42	1/2	3/4	1/2	1.60	41
26921-6-6	3/8	5/8x18	5/16	2.37	60	1.63	41	1/2	3/4	5/8	1.59	40
26921-8-8	1/2	3/4x18	13/32	2.63	67	1.78	45	5/8	7/8	3/4	1.71	43
26921-10-10	5/8	7/8x18	1/2	2.96	75	2.17	55	3/4	1-1/16	7/8	1.96	50

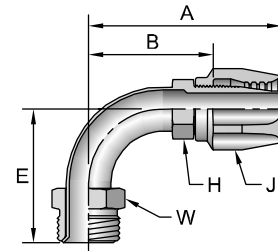

2S521

Male Tube- - Swivel - Short Pilot

# Part Number	Thread inch	Hose I.D. inch	A		D		H inch	J inch	K inch	B		
			inch	mm	inch	mm				inch	mm	
2S521-6-6	3/8	5/8x18	5/16	2.64	67	0.18	4,7	1/2	3/4	5/8	1.86	47

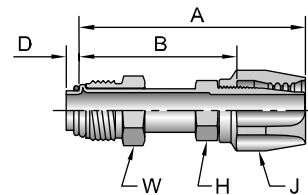

25M21

Male Tube- - Swivel - 0 Elbow - Long Pilot

# Part Number	Thread inch	Hose I.D. inch	A		D		E		H inch	J inch	K inch	B		
			inch	mm	inch	mm	inch	mm				inch	mm	
25M21-8-8	1/2	3/4x18	13/32	2.49	63	0.38	9,8	2.12	54	5/8	7/8	3/4	1.57	40
25M21-10-10	5/8	7/8x18	1/2	3.27	83	0.38	9,8	1.95	50	3/4	1-1/16	7/8	2.27	58

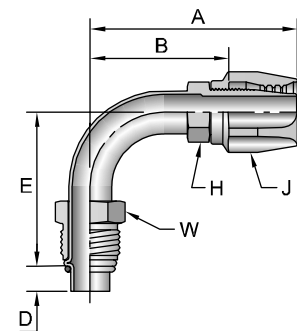

25S21

Female Tube- - Swivel - Short Pilot

# Part Number	Thread inch	Hose I.D. inch	A		D		H inch	J inch	K inch	B		
			inch	mm	inch	mm				inch	mm	
25S21-6-6	3/8	5/8x18	5/16	2.66	68	0.18	4,7	1/2	3/4	3/4	1.88	48
25S21-8-8	1/2	3/4x16	13/32	2.86	73	0.18	4,7	5/8	7/8	7/8	1.94	49

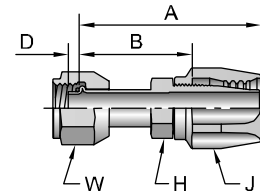

Hose

A

Fittings
21 Series

B

Equipment

C

Accessories

D

Technical

E

Hose
A

Fittings
21 Series
B

Equipment
C

Accessories
D

Technical
E

25H21

Female Tube- - Swivel - 45 Elbow - Short Pilot

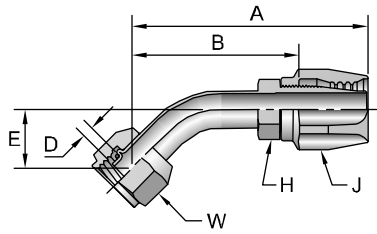

#			A		D		E					B	
Part Number	Thread inch	Hose I.D. inch	inch	mm	inch	mm	inch	mm	inch	inch	inch	inch	mm
25H21-8-8	1/2 3/4x16	13/32	2.74	70	0.18	4,7	0.60	15	5/8	7/8	7/8	1.82	46

25N21

Female Tube- - Swivel - 45 Elbow - Long Pilot

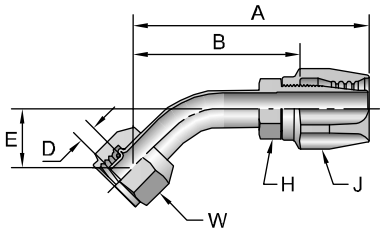

#			A		D		E					B	
Part Number	Thread inch	Hose I.D. inch	inch	mm	inch	mm	inch	mm	inch	inch	inch	inch	mm
25N21-8-8	1/2 3/4x16	13/32	3.24	82	0.38	9,8	0.98	25	5/8	7/8	7/8	2.32	59

25T21

Female Tube- - Swivel - 0 Elbow - Short Pilot

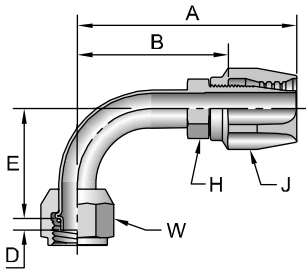

#			A		D		E					B	
Part Number	Thread inch	Hose I.D. inch	inch	mm	inch	mm	inch	mm	inch	inch	inch	inch	mm
25T21-6-6	3/8 5/8x18	5/16	2.35	60	0.18	4,7	1.21	31	1/2	3/4	3/4	1.57	40
25T21-8-8	1/2 3/4x16	13/32	2.83	72	0.18	4,7	1.31	33	5/8	7/8	7/8	1.91	49
25T21-10-10	5/8 7/8x14	1/2	3.33	85	0.18	4,7	1.50	38	3/4	1-1/16	1-1/16	2.33	59

25L21

Female Tube- - Swivel - 0 Elbow - Long Pilot

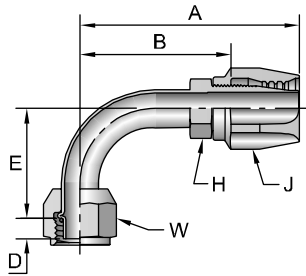

#			A		D		E					B	
Part Number	Thread inch	Hose I.D. inch	inch	mm	inch	mm	inch	mm	inch	inch	inch	inch	mm
25L21-6-6	3/8 5/8x18	5/16	2.28	58	0.28	7,1	1.43	36	1/2	3/4	3/4	1.50	38
25L21-8-8	1/2 3/4x16	13/32	2.50	64	0.38	9,8	1.46	37	5/8	7/8	7/8	1.58	40
25L21-10-10	5/8 7/8x14	1/2	2.83	72	0.38	9,8	1.75	44	3/4	1-1/16	1-1/16	1.83	46

21 Series

Hose Assembly Instructions

1. Identify over all length (OAL) of hose assembly and the cut off allowance (COA) length of fitting(s) on hose ends by use of the fitting data table. Properly measure, mark and cut hose to desired length using fine tooth hacksaw or a cutoff machine. Care should be taken to ensure a square, clean cut is obtained.
2. Air or solvent flush cut end of hose as necessary to produce a clean hose ID prior to assembly. Place socket in vice and screw in hose counter clockwise until hose bottoms. Back hose out 1/2 turn.
3. Oil inside of hose and nipple threads liberally with Hoze-Oil. (See Section C). Do not oil hose cover.
4. Screw nipple assembly into socket using a wrench on the nipple hex until the nipple hex shoulders against the socket. A 1/32" to 1/16" gap between the nipple hex and socket is allowed for displacement angle adjustment when elbow fittings are used.

Inspection. Examine hose assembly internally for cut or bulged tube, obstructions and cleanliness. Clean ID of hose as necessary. Swivel nuts should turn freely. Check the layline of the hose to be sure the assembly is not twisted. Cap the ends of the assembly to keep clean.

Special instructions for stainless steel fittings. When assembling fittings made with 316 stainless steel, lubricate the threads of both the socket and nipple with Accrolube High Efficiency Lubricant (see Section C) or equivalent metal assembly lubricant.

Note Disassemble in reverse order.

IF YOU HAVE QUESTIONS CONCERNING THE PRODUCTS OR APPLICATION OF THE PRODUCTS CONTAINED IN THIS CATALOG, PLEASE CALL: PARKER HOSE PRODUCTS DIVISION - TECHNICAL SERVICES DEPARTMENT
PHONE: 440 / 943-5700
FAX: 440 / 943-3129
<http://www.parkerhose.com>

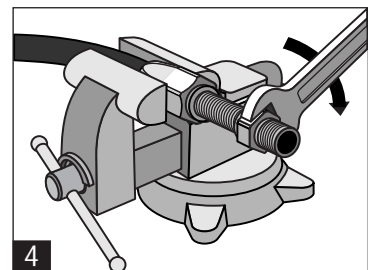
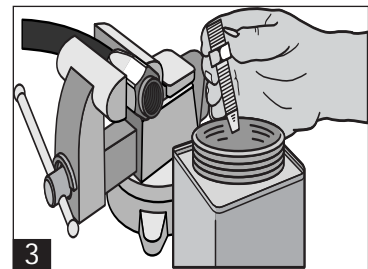
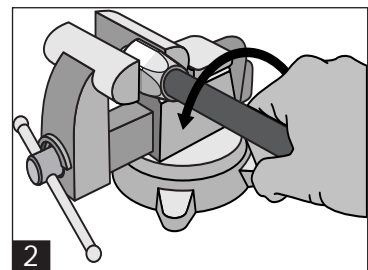
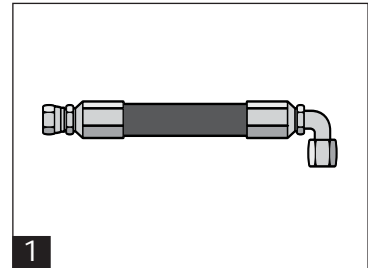

Hose
A

Fittings
21 Series
B

Equipment
C

Accessories
D

Technical
E

Hose
A

Fittings
21 Series
B







Equipment
C

Accessories
D

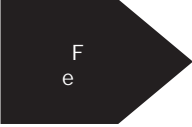
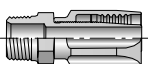
Technical
E

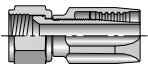

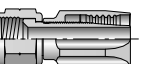
B-

	<p>20122 B-144</p>  <p>Female Rigid</p>		<p>20622 B-144</p>  <p>Female Swivel</p>		<p>20822 B-144</p>  <p>Female Swivel</p>
	<p>22 Series Assembly Instructions B-145</p>				

Hose
A

Fittings
22 Series
B

Equipment
C

Accessories
D

Technical
E

Hose
A

Fittings
22 Series
B

Equipment
C

Accessories
D

Technical
E

20122 Male NPTF Pipe - Rigid

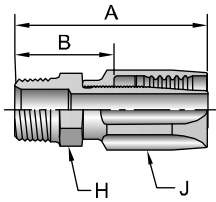

# Part Number	Thread		Hose I.D.		A		B		Additional Material Brass (B)
	inch	inch	inch	mm	H inch	J inch	inch	mm	
20122-2-4	1/8x27	3/16	1.72	44	7/16	5/8	0.94	24	
20122-4-4	1/4x18	3/16	1.92	49	9/16	5/8	1.92	29	
20122-4-5	1/4x18	1/4	2.01	51	9/16	11/16	1.18	30	
20122-4-6	1/4x18	5/16	2.11	54	9/16	13/16	1.19	30	
20122-6-8	3/8x18	13/32	2.49	63	3/4	15/16	1.40	36	
20122-12-12	3/4x14	5/8	3.25	83	1-1/16	1-1/4	1.75	44	

20622 Female JIC 37 - Swivel

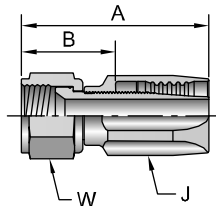

# Part Number	Thread		Hose I.D.		A		B		Additional Material Brass (B)
	inch	inch	inch	mm	J inch	inch	inch	mm	
20622-4-4	1/4	7/16x20	3/16	1.74	44	5/8	9/16	0.96	24
20622-5-5	5/16	1/2x20	1/4	1.91	49	11/16	5/8	1.08	27
20622-6-6	3/8	9/16x18	5/16	2.05	52	13/16	11/16	1.13	29
20622-8-8	1/2	3/4x16	13/32	2.55	65	15/16	7/8	1.46	37
20622-10-10	5/8	7/8x14	1/2	2.80	71	1-1/8	1	1.58	40
20622-12-12	3/4	1-1/16x12	5/8	3.15	80	1-1/4	1-1/8	1.65	42
20622-16-16	1	1-5/16x12	7/8	2.84	72	1-7/16	1-1/2	1.65	42
20622-20-20	1-1/4	1-5/8x12	1-1/8	3.00	76	1-3/4	2	1.72	44
20622-24-24	1-1/2	1-7/8x12	1-3/8	3.30	84	2	2-1/4	1.93	49
20622-32-32	2	2-1/2x12	1-13/16	4.05	103	2-1/2	2-7/8	2.31	59
20622-40-40	2-1/2	3x12	2-3/8	4.17	106	3-1/8	3-3/8	2.36	60

These 20622 fittings contain a dual seat that accepts both the JIC (37) and SAE (45) male configurations. The -6 and -12 SAE (45) swivel fittings are shown under part number 20822.

20822 Female SAE 45 - Swivel

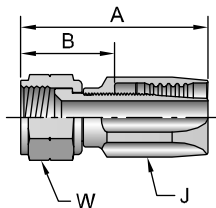

# Part Number	Thread		Hose I.D.		A		B		Additional Material Brass (B)
	inch	inch	inch	mm	J inch	inch	inch	mm	
20822-4-4	1/4	7/16x20	3/16	1.74	44	5/8	9/16	0.96	24
20822-5-5	5/16	1/2x20	1/4	1.91	49	11/16	5/8	1.08	27
20822-6-6	3/8	5/8x18	5/16	2.08	53	13/16	3/4	1.16	29
20822-8-8	1/2	3/4x16	13/32	2.45	62	15/16	7/8	1.36	35
20822-10-10	5/8	7/8x14	1/2	2.80	71	1-1/8	1	1.58	40
20822-12-12	3/4	1-1/16x14	5/8	3.10	79	1-1/4	1-1/4	1.60	41

Notch in nut for SAE (45) flare.

22 Series

(Mandrel Style) Hose Assembly Instructions

1. Identify over all length (OAL) of hose assembly and the cut off allowance (COA) length of fitting(s) on hose ends by use of the fitting data table. Properly measure, mark and cut hose to desired length using fine tooth hacksaw or a cutoff machine. Care should be taken to ensure a square, clean cut is obtained. Air or solvent flush cut end of hose as necessary to produce a clean hose ID prior to assembly. Place socket in vice and screw in hose counter clockwise until hose bottoms. Back hose out 1/2 turn.
2. When assembling male pipe ends, slide nipple onto mandrel.
3. When assembling swivel ends, slide swivel nut over nipple. Slide nut and nipple onto mandrel. Screw mandrel threads into nipple and wrench tighten.
4. Oil inside of hose and nipple threads liberally with Hoze-Oil. (See Section C). Do not oil hose cover.
5. Push nipple into socket.
Male ends: Thread nipple in until it bottoms against socket.
Swivel ends: Thread nipple into socket using hex on assembly mandrel. Leave clearance of approximately 1/32" (.784mm) between nut and socket to allow nut to swivel.
Remove mandrel.

Note Disassemble in reverse order.

Caution Do Not Attempt to Assemble These Fittings to the Hose without using a Mandrel.

Inspection. Examine hose assembly internally for cut or bulged tube, obstructions and cleanliness. Clean ID of hose as necessary. Swivel nuts should turn freely. Check the layline of the hose to be sure the assembly is not twisted. Cap the ends of the assembly to keep clean.

Special Instructions for Refrigerant Hose. Oil inside of hose and nipple threads liberally with the same oil used in refrigeration system. Do not oil hose cover. Do not allow hose to contact any petroleum base fluids.

IF YOU HAVE QUESTIONS CONCERNING THE PRODUCTS OR APPLICATION OF THE PRODUCTS CONTAINED IN THIS CATALOG, PLEASE CALL: PARKER HOSE PRODUCTS DIVISION TECHNICAL SERVICES DEPARTMENT
PHONE: 440 / 943-5700
FAX: 440 / 943-3129
<http://www.parkerhose.com>

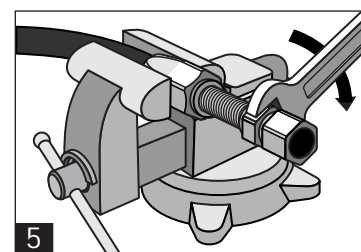
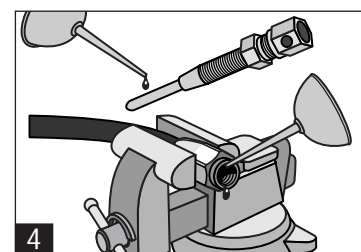
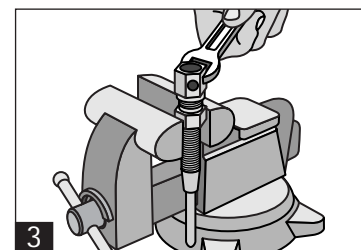
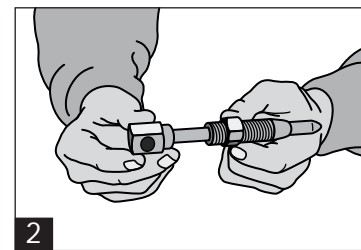
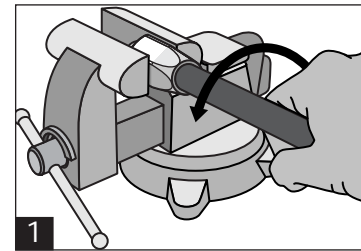

Hose
A

Fittings
22 Series
B

Equipment
C

Accessories
D

Technical
E